

# Radio-Electronics®

FOR MEN WITH IDEAS IN ELECTRONICS

## DUAL-TRACE TRIGGERED-SWEEP SCOPES Put One On Your Bench

### MULTI-FACETED WORLD OF INFRARED

### SEE HOW IT WORKS Digital Clock On A Chip

### BUILD YOUR OWN Low-Cost Keyboards

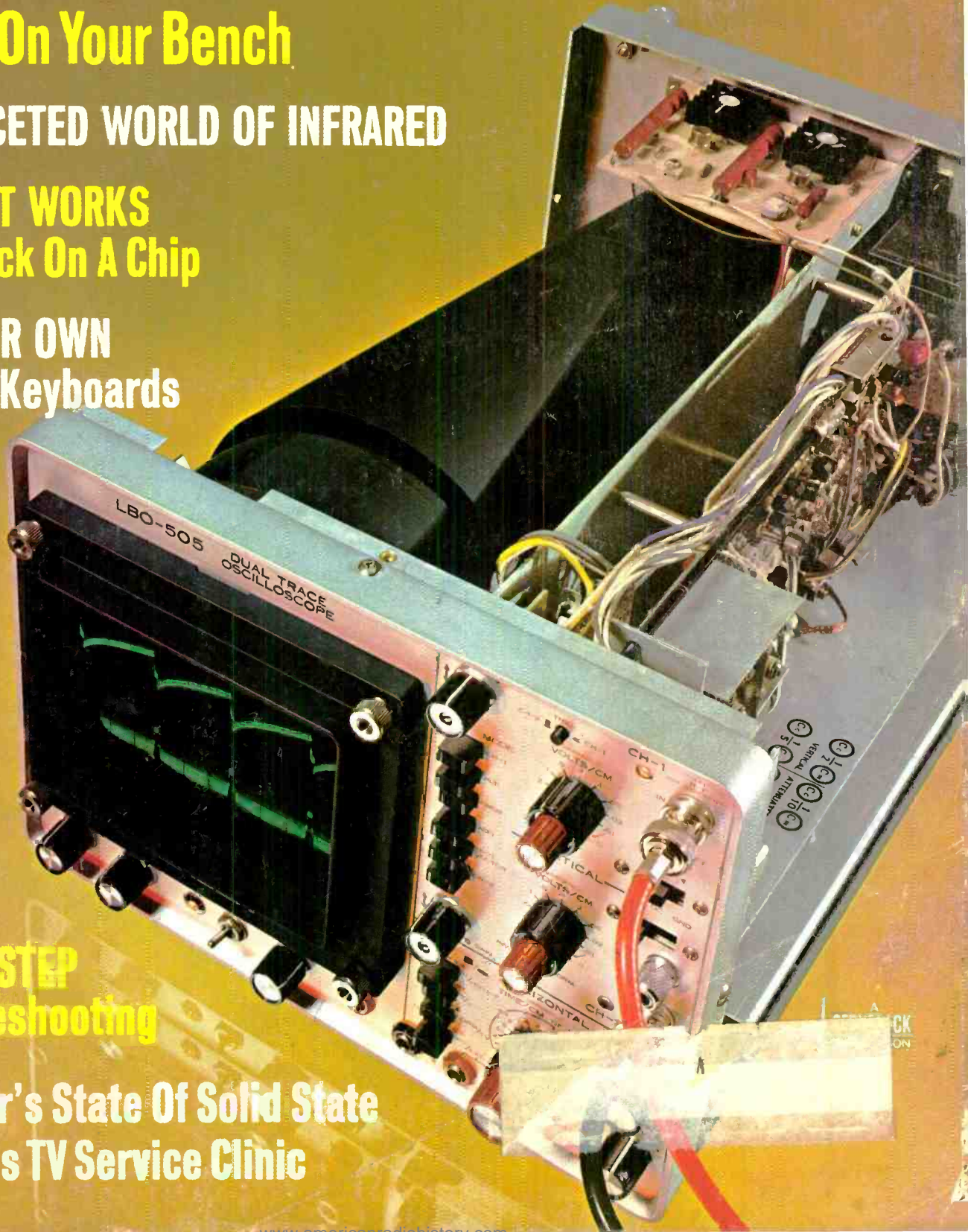

### STEP-BY-STEP TV Troubleshooting

### Lou Garner's State Of Solid State Jack Darr's TV Service Clinic

# This is what this catalog is all about.

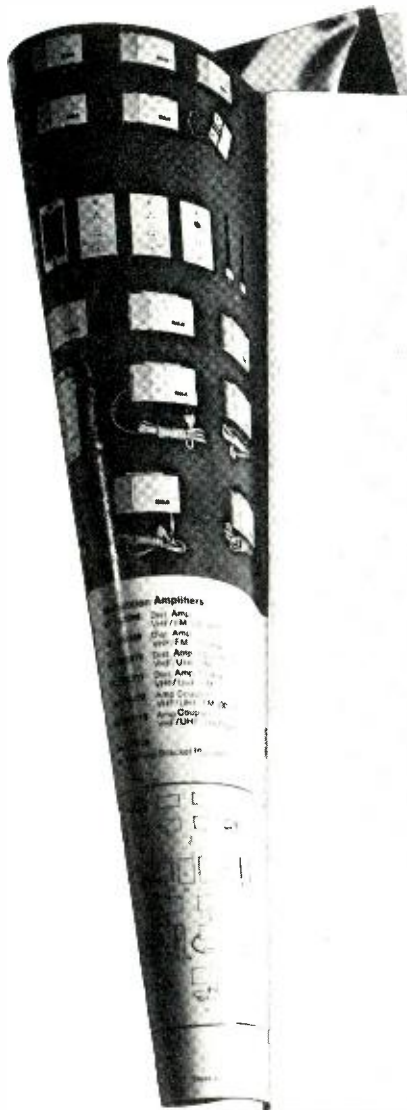

## A complete new look from RCA in Antenna System Accessories

RCA's all new line of Antenna System Accessories has been planned and designed to fulfill specific requirements of any antenna system in every detail. Covering every requirement from a simple passive two-set coupler up to a complete amplified, 82-channel coaxial multi-outlet distribution system for houses, offices, stores and small apartment buildings, this new line is complete in every respect and represents a new standard of performance, convenience and styling.

The entire line is advance-engineered by RCA to meet rigid performance standards. RCA's all-solid-state circuitry provides dependable trouble-free performance. Protection against lightning induced voltage surges is provided in all amplifiers. All passive devices designed for low insertion loss.

All housings have RCA's "new-look styling" in molded high IMPAC® plastic cabinets. Similar styling design for all models presents a uniform appearance for a complete line.

Installation convenience . . . mounting is simplified with the use of the new RCA "slip-on" clamps. No solder connections are required to connect any model into a system. Serrated washers simplify connecting 300-ohm line to the devices. All hardware, complete installation instructions and system wiring connectors are included with every model.

### INDEX

Multi-Set Couplers	3
Band Separators (Back of Set)	5
(Wall Mount)	7
Matching Transformers	8
Antenna Couplers	9
Interference Filters and Traps	11
Wall Outlets and Plugs	13
Preamplifiers	16
Distribution Amplifiers	24
Typical Distribution Systems	31

## This is how to get it.

The RCA Antenna Systems Accessories Catalog is the TV service dealer's complete guide to better reception for his customers and more sales. So tune in and get your free copy today with absolutely no obligation. Ask your local RCA Parts and Accessories distributor how to get your free copy, or fill out and mail the attached coupon.



**RCA Parts and Accessories  
Distribution Services  
2000 Clements Bridge Road  
Deptford, New Jersey 08096**

Please send me a free copy of the RCA Antenna Systems Accessories Catalog.

Name \_\_\_\_\_  
 Business \_\_\_\_\_ Phone \_\_\_\_\_  
 Address \_\_\_\_\_  
 City \_\_\_\_\_ State \_\_\_\_\_ Zip \_\_\_\_\_

RE-2

# FREE...demonstration lesson to prove that you can learn TV servicing at home.

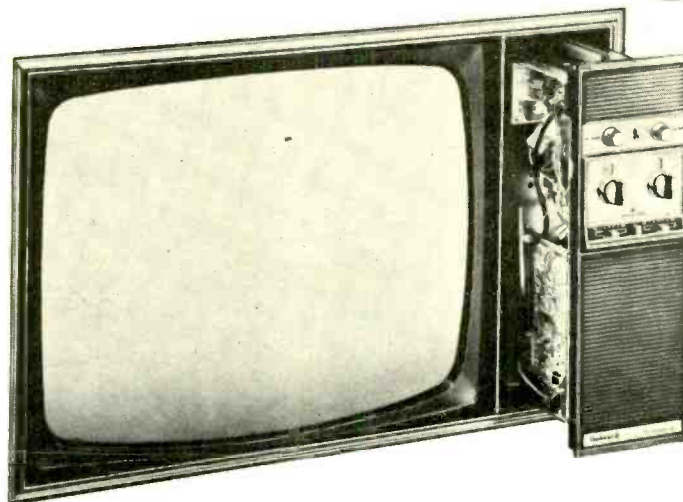

Practice on a new 25" MOTOROLA QUASAR II® chassis.

TV Servicing is a satisfying career . . . and the pay is great. Qualified men are needed now to maintain the 93 million sets in U.S. homes. And prospects for the future are even brighter.

Now . . . here's an opportunity for you to prove to yourself that **you** can learn TV Servicing . . . at home, in your spare time. ICS, the world's most experienced home-study school, will send you a **FREE** Demonstration Lesson (complete with sample questions) if you will merely fill out the coupon below and mail it to us.

In addition to your free demonstration lesson, we'll send you . . . also **FREE** . . . a brochure that describes the 25" (diagonally measured screen) MOTOROLA QUASAR II® Color TV chassis that we include in our TV Service Training Program.

This chassis with automatic fine tuning control is ideal for training purposes because it combines solid state devices with vacuum tubes to give you both kinds of practical experience.

Credit towards a Certified Electronic Technician (C.E.T.) rating will be granted by the National Electronics Association to ICS students upon completion of the ICS Career Program in TV Service/Repair.

# ICS

International Correspondence Schools  
Since 1890  
School of Electronics  
Scranton, Pa. 18515

Approved for veterans under the new GI bill/approved for federally insured loans/ Accredited by the Accrediting Commission of the National Home Study Council.

Canadian residents use above address for service from ICS Canadian, Ltd. in Hawaii use Post Office Box 418, Honolulu.

All parts carry Motorola's two year replacement guarantee!

The QUASAR II chassis comes to you in three basic sub-assemblies . . . NOT AS A KIT . . . because we want you to learn how to **repair** TV sets, not build them.

Our free literature also describes the fully assembled test equipment you receive such as the Deluxe 5" Solid State Oscilloscope, the tools and the learn-by-doing kits, all of the finest quality.

And we're going to tell you about eight other career opportunities in Electronics and the ICS Career Programs that can help prepare you for them. All you've got to do is mail the coupon. **SEND IT TODAY!**

**ICS School of Electronics Dept. BA-203P  
Scranton, Pa. 18515**

YES, I want you to mail to me without obligation, the FREE DEMONSTRATION LESSON and complete literature on the career program checked below. (Please check one.)

- |   |  |
|---|--|
| <input type="checkbox"/> Color TV Servicing   | <input type="checkbox"/> FCC License                 |
| <input type="checkbox"/> Computer Maintenance | <input type="checkbox"/> Communications/Broadcasting |
| <input type="checkbox"/> CATV Installation    | <input type="checkbox"/> Hi-Fi Sound Systems         |
| <input type="checkbox"/> Telephony            | <input type="checkbox"/> Industrial Electronics      |
| <input type="checkbox"/> ELECTRICIAN          |  |

Name \_\_\_\_\_ Age \_\_\_\_\_

Address \_\_\_\_\_

City \_\_\_\_\_

State \_\_\_\_\_ Zip \_\_\_\_\_

Circle 2 on reader service card



# Radio-Electronics

FOR MEN WITH IDEAS IN ELECTRONICS

February 1973

## SPECIAL FEATURES

- 35 **Inside The IC Digital Clock**  
See how the one-chip IC used in a digital clock works.  
*by Larry Sullivan*
- 39 **Multifaceted World Of Infrared**  
What's happening and how it affects modern electronics.  
*by Forest Mims*

## BUILD ONE OF THESE

- 51 **Grinchwal Mainframe Readout**  
*by Don Lancaster*
- 54 **Low-Cost Keyboards**  
Make your own custom design for less than 25 cents a key. *by Don Lancaster*
- 58 **IC Breadboard—Using The Digi Designer**  
Build a simple computer. *by Jack Cazes*
- 69 **Build Dual-Function Photometer**  
It's easy to build and handy to own. *by Harold Pallatz*

## GENERAL ELECTRONICS

- 4 **Editorial**  
The whole truth.
- 6 **Looking Ahead**  
Tomorrow's news today. *by David Lachenbruch*
- 26 **Equipment Report**  
Aries pocket calculator kit.
- 32 **Equipment Report**  
Onkyo TX-666 stereo receiver.
- 60 **State Of Solid State**  
New developments in solid-state electronics today.  
*by Lou Garner*

## TEST EQUIPMENT

- 43 **Dual-Trace Triggered Sweep Scopes**  
How they work and how you can use them.  
*by Forest Mims*

## TELEVISION

- 62 **Step-By-Step Troubleshooting Charts**  
The agc amplifier. *by Art Margolis*
- 71 **TV Service Clinic**  
Troubleshooting intermittents. *by Jack Darr*
- 78 **Reader Questions**  
R-E's Service Editor solves reader problems.

## DEPARTMENTS

- |    |                |     |                     |
|----|----------------|-----|---------------------|
| 22 | Letters        | 100 | Next Month          |
| 12 | New & Timely   | 90  | Try This            |
| 96 | New Books      | 98  | Noteworthy Circuits |
| 86 | New Literature | 111 | Reader Service Card |
| 82 | New Products   | 102 | Technotes           |

**SEMICONDUCTOR DIRECTORY, planned for this issue will appear in March. See p. 100.**



**THIS MSI IC made by Mostek is just about the complete electronics for a digital clock. To learn how it works.....turn to page 35**

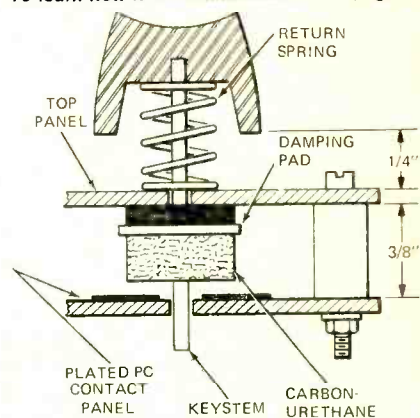

**CONSTRUCTION DETAILS of a keyboard switch you can build for less than 25 cents. ....turn to page 54**

Hugo Gernsback (1884-1967)  
founder

M. Harvey Gernsback, editor-in-chief  
and publisher

Larry Steckler, editor, CET  
Robert F. Scott, W2PWG technical editor, CET  
Jack Darr, service editor, CET  
Louis E. Garner, Jr., semiconductor editor  
I. Queen, editorial associate  
Matthew Mandl, contributing editor  
David Lachenbruch, contributing editor  
James A. Gupton, Jr., photographic electronics  
Vincent P. Cienia, production manager  
Nancy Gipson, production assistant  
H. Matysko, circulation

Cover photograph by Walter Herstatt  
Cover design by Marius Trinqué

Radio-Electronics is indexed in *Applied Science & Technology Index* and *Readers Guide to Periodical Literature*.



Radio-Electronics, February 1973, Vol. 44, No. 2. Published monthly by Gernsback Publications, Inc., 200 Park Avenue South, New York City 10003. Second-class postage paid at New York, N. Y. and additional mailing offices. One-year subscription rate: U.S.A., U.S. possessions and Canada: \$7; Pan-American countries: \$8; Other countries: \$8.50. Single copies 60c. © 1973 by Gernsback Publications, Inc. All rights reserved. Printed in U.S.A.

Subscription Service: Mail all subscription orders, changes, correspondence and Postmaster Notices of undelivered copies (Form 3579) to Radio-Electronics Subscription Service, Boulder, Colo. 80302

---

# editorial

## *the whole story*

In the *letters* column this month, you will find a detailed message from Frank Moch, executive director of NATESA (National Alliance of Television and Electronic Service Associations). It's addressed to Bess Myerson and is concerned with the practices used by consumer protection groups to check out TV service technicians.

Frank Moch's letter, coupled with a recent newspaper story in New York City, has prompted this editorial. A few months ago New York's daily newspapers carried a story that told of a check run on eight TV repair shops. It specified how seven of the eight shops checked proved to have a dishonest operation. The implication was that the TV set owner in New York City had only one chance in eight of finding an honest shop to get his set working.

Concerned by the article, we checked with the consumer protection agency and obtained a copy of their complete report. In reading the report, including the fine print, we found that it was true that seven of the eight shops were dishonest. But—and this is the key to the whole thing—the seven dishonest shops **were selected on the basis of numerous prior complaints.**

Therefore, this was not a random sampling and should not have appeared to be representative of the entire TV service industry in the city. Unfortunately, the qualifying remark was located near the bottom of the report and apparently was not noted by all of the newspapers who picked up the item.

All professions harbor small number of dishonest businessmen. But to distort and paint every TV service technician as a dishonest operator is a terrible injustice. The vast majority of TV service technicians are honest, hard-working businessmen—men who are really concerned with repairing a set and returning it in good shape to their customer as soon as possible and with as reasonable a fee as possible.

We call on all consumer protection agencies and news reporting media to be much more careful in how they fling their statements about. By all means, we do want to see the dishonest operator put out of business. But, unfortunately, the dishonest operation has considerable legal protection while the honest operator appears to be wide open to take the rap for the dishonest minority.

When reporting on any TV service operation, we ask that the media be sure to get the whole story in the first paragraph of their report every time. And wouldn't it be different, if just once, the typical **honest** technician was in the news?

---Larry Steckler, Editor

# Look for the PTC *Please The Customer* Semiconductor Mart at your Mallory Distributor's.

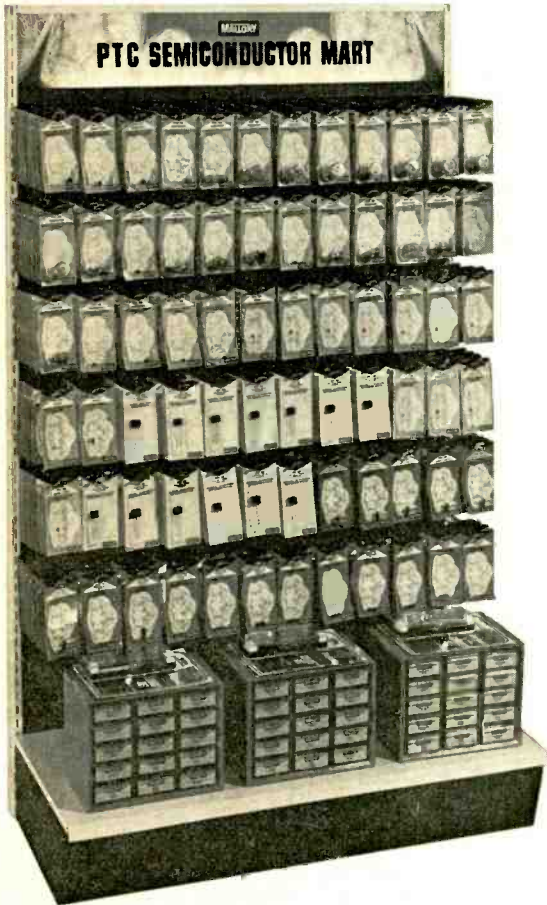

**THE SEMICONDUCTOR MART.** Here's the quick, easy way to get the replacements you need. It's the best assortment of the hottest semiconductors around. Transistors, diodes, multiple diode packages, zener diodes and integrated circuits included.

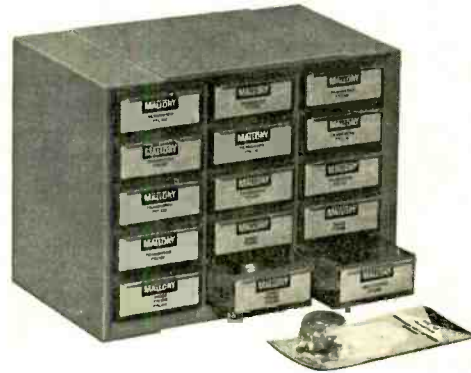

**THE FAMOUS MALLOBIN WAREHOUSE.**  
With the semiconductors most needed by service technicians.



**FREE** copies of the very latest cross-referenced Semiconductor Product Guide.

Clear, concise product data on the packages makes your choice easy. And Mallory quality, versatility, and dependability make every choice a good one.

## You know what you need. Now you know where to find it.

**MALLORY**

**MALLORY DISTRIBUTOR PRODUCTS COMPANY**  
a division of P. R. MALLORY & CO. INC.  
Box 1284, Indianapolis, Indiana 46206; Telephone: 317-636-5353  
*Circle 3 on reader service card*

FEBRUARY 1973 • RADIO-ELECTRONICS 5

# looking ahead

## Narrowcasting

That word is the opposite of broadcasting. And it describes the new Multipoint Distribution Service (MDS) authorized by the FCC and expected to go into service early this year. MDS is a commercial service designed to provide low-cost visual communications between a central point in a metropolitan area and several receiving locations for private or semi-private use. The FCC has set aside the 2150 to 2160-MHz portion of the spectrum for MDS, allotting one channel per area.

Under the MDS system, the local FCC licensee establishes a central transmitting point in an area and sells time to local businesses which wish to transmit pictures to various points within a 15 to 25-mile radius. Small parabolic antennas are installed at the receiving locations. The transmitted signals may be digitally encoded so that specific program time segments may be received only by the locations for which they were intended. For example, if Coca-Cola is sponsoring a televised sales meeting from 2:30 to 3 PM and Pepsi-Cola a meeting from 3 to 3:30, neither location would be able to spy on the other's sales message.

Microband Corporation of America, which has received the first permit for such service, in Washington, D.C., and has applied for licenses in 32 other cities, is promoting MDS as the lowest-cost form of visual communications available—cheaper than videocassettes or even movie projection. If 10 or more viewers watch in a single location, Microband says, it should cost less than a dollar per viewer for each 25-minute program presented twice weekly on a year's contract.

Another firm, affiliated with Microband, has signed up most of the current applicants for MDS service to affiliation contracts, so that nationwide televised meetings may be held. The affiliates would receive the program material by microwave, communications satellite or air-expressed videotapes. In addition to business meetings, Microband says its services will be used for ethnic programming to community centers, religious services to churches and pay-TV movies to motels. The FCC is currently considering whether to assign a second MDS channel to the current service. It appears to be the start of a new nationwide TV intercom service—or, as Microband puts it, "hundreds of private TV networks."

## Talking pictures

You have a couple of beautiful art masterpieces on your wall, see? And you turn on the stereo. Suddenly you get fantastic sound, with no apparent speakers in evidence. It's your paintings trying to tell you something. That's the latest audio product from Fisher Radio. The patented "Sound Panels" actually are flat speakers masquerading as paintings. But unlike some flat speakers, these are claimed to be superior to acoustic-suspension types in efficiency and sound dispersion, and equal in frequency response. Each speaker has two drivers attached to the rear of an expanded polymer diaphragm. The diaphragm radiates energy over its entire surface, dispersing sound in a 360-degree pattern. Eight different paintings, or "Sound Panels," are being offered, at about \$138 each. The paintings are on fabric—you can't use one of your own pictures. The

logical follow-up might be a kit which lets you paint your own loudspeaker by numbers.

## The videoplayer market

The first cassette videotape recorders designed exclusively for the home are now on sale in most major markets throughout the United States and Canada. Sold under the brand names of Admiral, Emerson, Montgomery Ward, Sears and Teledyne Packard Bell, they all use the Cartrivision deck, manufactured by Cartridge Television Inc. A network of sales and rental outlets for pre-recorded programming is now being assembled. The first Cartrivision models are all 25-inch color sets with built-in recorder-players and sell at a relatively steep \$1300 to \$1600, with a black-and-white camera about \$250 extra.

At these prices, obviously, this is not yet a mass-market product, but the manufacturer of decks is just starting up and couldn't fill huge orders. Toward the end of 1972, it's estimated that perhaps 5,000 units had been shipped to dealers, and total orders by manufacturers for the decks came to about 15,000. Later this year, some manufacturers will introduce a stand-alone playback-only Cartrivision deck for attachment to any color set at about \$700.

That's the same price which RCA projects for its MagTape Selecta-Vision play-and-record deck, which has a built-in digital clock-timer so that programs may be recorded when the set owner isn't home. This is scheduled to come on the market late this year. It's not compatible with the Cartrivision unit, of course.

However, the most successful videocassette recorder isn't a home unit at all, but Sony's U-Matic sys-

tem, which is finding many uses in education, industry and commerce. Sony has produced about 40,000 of these, selling most of them in the United States, and expects to make about 100,000 this year. In the United States, a record-and-play U-Matic costs \$1,395 and a playback-only unit is \$995. The principal attraction of the Sony unit is its operational simplicity and reliability. Although the U-Matic isn't compatible with either the Cartrivision or the upcoming Selecta-Vision system, Sony feels that it will become the consumer standard. However, Sony officials say a real market for a home U-Matic won't come for another five years—by which time mass production and integrated circuitry will have reduced the cost of a record-play unit to about \$500. By that time, Sony foresees sales of at least a million units per year.

## Midget digits

A new electronic watch circuit that is small enough to be incorporated into a petite ladies' watch, or to permit the addition of an automatic calendar, is being designed by the Inselek Corporation of Princeton, N.J., under contract to Optel, Inc., of the same city.

At the heart of the circuit is a newly designed "silicon-on-sapphire" (SOS) IC, to be used in combination with a liquid-crystal digital display. The SOS circuit is claimed to be smaller, more accurate and lower in cost than the conventional all-silicon ICs. The target for marketing the first SOS watches is late this year. Price of the new timepieces has not yet been determined by the manufacturer.

by DAVID LACHENBRUCH  
CONTRIBUTING EDITOR



# SERVICE

technicians know that Color TV repair demands more time and effort. That's why Sprague strives to simplify Color TV capacitor selection.

# COLOR

TV capacitors by Sprague come in the exact ratings required to meet the exacting requirements of Color TV.

# TV

service becomes more demanding as Color TV keeps expanding. That's why exact capacitor ratings are important. They help you to restore original set performance.

# EASIER

selection of replacement capacitors for Color TV is assured when you look to the broad Sprague line. You'll get the capacitor you need—when you need it—every time.

Just off the press! See your Sprague Distributor for a free copy of our new 40-page K-111 Twist-Lok® and Print-Lok® Capacitor Replacement Manual, or write to: Sprague Products Company, 81 Marshall St., North Adams, Mass. 01247



**THE BROAD-LINE PRODUCER OF ELECTRONIC PARTS**

Circle 4 on reader service card

FEBRUARY 1973 • RADIO-ELECTRONICS 7

# Discover the ease and excitement of learning Electronics with programmed equipment NRI Sends you

When you train at home with NRI, you train with your hands as well as your head. You learn the WHY of Electronics, Communications, TV-Radio the NRI pioneering "3-Dimensional" way. NRI training is the result of more than half a century of simplifying, organizing, dramatizing subject matter, and providing personal services unique for a home study school. You get the kind of technical training that gives you priceless confidence as you gain experience equal to many, many months of training on the job.



*NRI—The Leader in Electronics Training for more than Fifty Years*

## APPROVED UNDER NEW GI BILL

If you served since January 31, 1955, or are in service, check GI line in postage-free card.



Earn \$5 to \$7 an hour  
spare or full time in

## TV-RADIO SERVICING

Color television sales are soaring. And so is the demand for trained repairmen. If you can service TV sets, portable radios, tape recorders, hi-fi sets, phonographs and auto radios, you'll always be in demand. It's one of your best routes to spare-time earnings, a good paying job or a business of your own. NRI trains you quickly and expertly, showing you how to get started in servicing soon after you enroll, earning as you learn. NRI trains you in today's method of installing and repairing all electronic equipment for the home—including solid state Color TV. You even build, experiment with and keep to enjoy your own solid-state radio plus your choice of black-and-white or the new 25" solid state Color TV receiver NRI developed from the chassis up for training. Like thousands of others, you can soon be earning good money in your spare time . . . the easy NRI way.

There's money and  
success awaiting you in

## BROADCASTING— COMMUNICATIONS

The experience you gain from intensely practical NRI training in Complete Communications equals as much as two years of training on the job. With NRI, you can train for a choice of careers ranging from mobile, marine and aviation radio to TV broadcasting and space communications. You learn how to install, maintain and operate today's remarkable transmitting and receiving equipment by actually *doing* it. You build and experiment with test equipment, like a VTVM you keep. You build and operate amplifier circuits, transmission line and antenna systems, even build and use a phone-cw transmitter suitable for transmission on the 80-meter amateur band. Whichever of five NRI Communications courses you choose, you prepare for your FCC License exams, and *you must pass your FCC exams or NRI refunds your tuition in full.*

Move ahead in America's  
fast growing industry as

## ELECTRONICS TECHNICIAN

Electronics touches everyone's lives. This vast field of opportunity is open to you with NRI training. Industrial/Military Electronics training—like all NRI courses—prepares you quickly, thoroughly the practical "hands on" way. You build with, and learn to understand the functions of, today's miracle solid-state components like printed circuits, diodes and transistors. You build and experiment with Electronic circuitry used in automation, data processing, ultrasonics, telemetry. Bite-size texts make studying easier. Whatever your interest in Electronics, NRI training can fill your needs. Prove to yourself what nearly a million NRI students could tell you . . . that you get more for your money from NRI. Check the postage-free card and mail it today for your FREE NRI Color Catalog. NO SALESMAN WILL CALL. NRI Training, 3939 Wisconsin Ave., Washington, D.C. 20016.

# YOU GET MORE FOR YOUR MONEY FROM NRI



## NRI Kits and Equipment

Dollar for dollar, you get more value from NRI training kits, because they are designed as educational tools. In the TV-Radio Servicing Course, for instance, the end product is a superb 25" color TV your whole family will enjoy. The set is designed so that, while building it, you can introduce and correct defects . . . for trouble-shooting and hands-on experience in circuitry and servicing. The kits include, at no additional cost, a wide-band service type oscilloscope and color crosshatch generator, and other valuable equipment that will let you start earning money in your spare time making repairs . . . even before the course is completed.

# new & timely

## Electronic tranquility machine relieves headaches, insomnia

An electronic "tranquility machine" that relieves nervous tension and quickly cures many types of headaches, was demonstrated at the 58th annual convention of the Jewish women's service organization, Hadassah. The device was developed by scientists of the Electro-Sleep Clinic of the Hadassah-Hebrew university in Tel Aviv, Israel. It is about the size of a large transistor radio.

No description of the electronic operation of the Instrument was given at the convention. It appears to be a form of the electronic sleep instruments developed by researchers in the United States and Russia, as well as in Israel. As described, it is milder in its effects than the electronic sleep instruments; It is said to produce a state of relaxation "bordering on sleep."

Some headaches not curable by drugs have been successfully treated with the machine. On the other hand, according to Dr. Florella Magora of the University, some persons simply do not respond to it. Not only have headaches and insomnia been successfully treated, but general tension usually yields to the machine, and it has been effective in allergic asthma and certain types of migraine.

Five years experience with the device, states Dr. Magora, have shown decisively that its benefits have no detrimental side effects. This makes it possible for the patient to use it at home, simply placing three electrodes on the head, pushing the starting switch and setting a timer to turn off the instrument when the desired time of treatment has been completed.

## Airborne nuclear refrigerator cools to $-320^{\circ}$ F.

A nuclear cryogenic refrigerator that produces temperatures as low as  $-196^{\circ}$  C ( $-320^{\circ}$  F or  $77^{\circ}$  K) has been demonstrated at the Mound Laboratories of Miamisburg, Ohio. It was developed for the Atomic Energy Commission by Hughes Aircraft Co.

Such low temperatures are needed to cool infrared and other sensors to temperatures at which they reach their greatest sensitivity. Earlier units, using electricity as a source of the heat energy that activates these refrigerators, have been used successfully in space, air and ground systems.



**THREE CYLINDERS OF PLUTONIUM 238** provide the energy for the cryogenic 'fridge, which cools things down to more than 300 degrees below zero. The young lady inserting the tubes is Pamela Gleason of Hughes' cryogenic department.

But vehicles such as spacecraft often have no electrical power to spare, and this first nuclear unit, using radio isotopes, therefore has important advantages. Three small capsules of Plutonium 238 are all that is required to produce the super-cooling.

It may seem odd to use heat to produce cold, but the principle has been used in home gas refrigerators, such as the old Norge ("Cools with Heat!"). The heat evaporates a liquid, which absorbs heat as it returns to the liquid state.

## New laser-beam light switch has future in electrooptics

Bell Laboratories scientists have developed and demonstrated an experi-



**THE THIN FILM LIGHT SWITCH** that may be part of future optical circuits for putting phone calls and data on a light beam. Pencil points the path of the light wave.

mental light switch, for switching a beam of laser light. Scientists have been seeking such a switch as part of future electro-optical systems that would transmit large amounts of information over light beams.

The switch is an yttrium gallium scandium garnet film, about 2.5 microns thick, grown on a gadolinium garnet substrate. It is the center wafer in the photograph. It acts as a waveguide for light-waves, two types of which, the TM (transverse magnetic fields) and TE (transverse electric fields) can pass through it. The wafer also carries a zig-zag (serpentine) electric circuit, which sets up a tiny magnetic field when current passes through it.

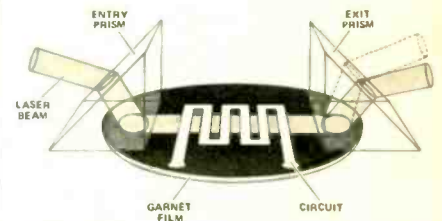

**SCHEMATIC DRAWING** of the light switch, showing how the output waves are separated.

The wafer is positioned between two prisms that couple the light beam into and out of it. The exit prism guides the beam in one direction if it is a TM type of lightwave and in a slightly different direction if it is of the TE type.

Light is fed into the input prism in the TM mode, and passes across the wafer, over the serpentine circuit, and out via the exit prism. When current is passed through the circuit, the beam is changed from TM to TE, and thus follows a different path on leaving the prism than does the light passed when the serpentine circuit is switched off. This makes it possible to code information into the beam.

Bell scientists see the possibility of many improvements over the present experimental device. These may result in simplifying it to a very small thin film and a tiny electric circuit, without the comparatively bulky prisms.

## Sixth amateur radio satellite has several new features

OSCAR VI (Orbiting Satellite Carrying Amateur Radio) recently sent into space aboard a NASA Delta space rocket from the Western Test Range in California, dif-

(continued on page 14)

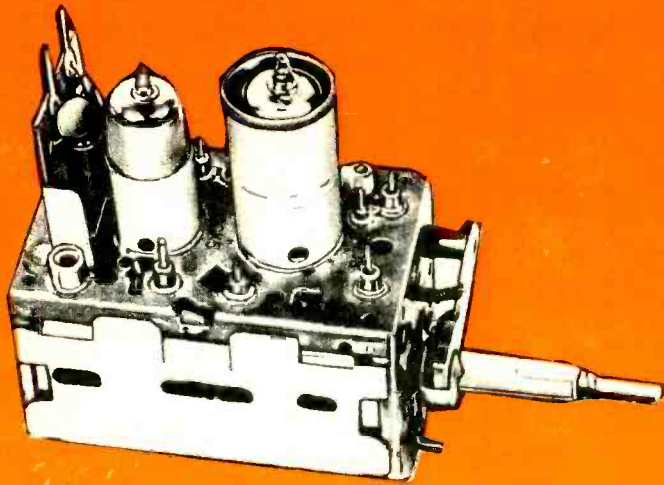

# \$9.75

ALL PARTS INCLUDED

ONE YEAR GUARANTEE

## TUNER SERVICE CORPORATION

**PROVIDES YOU WITH A COMPLETE SERVICE FOR ALL YOUR TELEVISION TUNER REQUIREMENTS.**

### REPAIR

VHF Or UHF Any Type \$9.75.  
UHF/VHF Combo \$15.00.

In this price all parts are included. Tubes, transistors, diodes, and nuvistors are charged at cost.

Fast efficient service at our 10 conveniently located service centers.

All tuners are cleaned inside and out, repaired, realigned and air tested.



### TUNER SERVICE CORPORATION FACTORY-SUPERVISED TUNER SERVICE

Backed by the largest tuner manufacturer in the U.S.—SARKES TARZIAN, Inc.

<b>HEADQUARTERS</b> .....	537 SOUTH WALNUT ST., Bloomington, Indiana 47401 .....	TEL: 812-332-7251
<b>ARIZONA</b> .....	2629 NORTH FIRST AVE., Tucson, Arizona 85717 .....	TEL: 602-791-9243
<b>CALIFORNIA</b> .....	SARKES TARZIAN, Inc. TUNER SERVICE DIVISION 10654 MAGNOLIA BLVD., North Hollywood, Calif. 91601 .....	TEL: 213-769-2720
<b>FLORIDA</b> .....	1505 CYPRESS ST., Tampa, Florida 33606 .....	TEL: 813-253-0324
<b>GEORGIA</b> .....	938 GORDON ST., S. W., Atlanta, Georgia 30310 .....	TEL: 404-758-2232
<b>INDIANA</b> .....	817 N. PENNSYLVANIA ST., Indianapolis, Ind. 46204 .....	TEL: 317-632-3493
	6833 GRAND AVE., Hammond, Indiana 46323 .....	TEL: 219-845-2676
<b>KENTUCKY</b> .....	2920 TAYLOR BLVD., Louisville, Kentucky 40208 .....	TEL: 502-634-3334
<b>NEW JERSEY</b> .....	547-49 TONNELE AVE., Jersey City, New Jersey 07307 .....	TEL: 201-792-3730
	(On U. S. Highway 1 & 9)	
<b>TENNESSEE</b> .....	1215 SNAPPS FERRY RD., Greenville, Tennessee 37743 .....	Tel: 615-639-8451
	1703 LAMAR AVE., Memphis, Tennessee 38114 .....	TEL: 901-278-4484
<b>TEXAS</b> .....	11540 GARLAND RD., Dallas, Texas 75228 .....	TEL: 214-327-8413
<b>VIRGINIA</b> .....	4538 PRINCESS ANN ROAD, Norfolk, Virginia 23502 .....	TEL: 703-855-2518

WATCH US GRCW

Circle 5 on reader service card

### REPLACE

Replacement Tuner \$9.75.

This price buys you a complete new tuner built specifically by SARKES TARZIAN INC. for this purpose.

All shafts have a maximum length of 12" which can be cut to 1½".

Specify heater type parallel and series 450mA or 600mA.

### CUSTOMIZE

Customized tuners are available at a cost of only \$15.95.

Send in your original tuner for comparison purposes to:

# FREE

send now for the *all new*

# Olson

1973 CATALOG



## Your Savings Guide to Everything in Electronics

Here's your NEW and complete annual buying guide to:

- Everything in audio & hi-fi
- Tape recorders & accessories
- Radios & phonos of all kinds
- New build-your-own kits
- Auto electronics & accessories
- Citizens Band two-way radios
- VHF & UHF police/fire monitors
- Amateur & shortwave radio
- Electronic security equipment
- TV-FM antennas • Test gear
- Books, parts bargains, tubes, transistors, wire, more!

**NOW!** Send for the only catalog with a wide selection of **THE BEST OF THE FAMOUS BRANDS**

**OLSON EXCLUSIVES!**

**FREE**

See special products & values sold only by Olson including our all-new TELEDYNE stereo line.

Many full-color pages!

**Olson Electronics**



Olson Electronics Dept. LC  
260 S. Forge St., Akron, Ohio 44327  
 Send FREE 1973 Olson catalog

Name \_\_\_\_\_ Apt. \_\_\_\_\_

Address \_\_\_\_\_

City \_\_\_\_\_

State \_\_\_\_\_ Zip \_\_\_\_\_

Name \_\_\_\_\_ Apt. \_\_\_\_\_

Address \_\_\_\_\_

City \_\_\_\_\_

State \_\_\_\_\_ Zip \_\_\_\_\_

Circle 6 on reader service card

# new & timely

(continued from page 12)

fers from the five previous Oscars in several important respects.

Using batteries rechargeable by the sun, its life is expected to be at least a year. It operates in a circular polar orbit 900 miles from Earth. It receives amateur signals on 2 meters and retransmits them in the 10-meter band, thus permitting international communication on frequencies heretofore limited to short-range operation, by many more amateurs than before, this includes many hams in developing countries who have not previously had any opportunity for experience with space communication via satellite.

OSCAR VI is also expected to offer greater opportunities to schools to provide laboratory experience in several aspects of space science. Three of NASA's "Spacemobiles" which visit schools for demonstration purposes will be equipped for OSCAR VI use.

Coordinating arrangements for the NASA launch is AMSAT—the Amateur Radio Satellite Corporation—a volunteer group of radio amateurs headquartered in Washington, DC. The official tracking station will be operated by a group of hams at the Talcott Mountain Science Center in Avon, Connecticut.

## First domestic satellite is launched in Canada

Anik, the world's first domestic communications satellite, went into orbit November 9 last, to tie all Canada together in one communications network. In an equatorial orbit 22,300 miles above Earth, it can "see" all of Canada from Newfoundland to the Yukon-Alaska border—a distance about 1,000 miles greater than that from New York to San Francisco—and from the United States boundary to points in the far north where broadcast listeners hear Moscow and Berlin better than they do Toronto and Montreal.

Anik (which means "brother" in Eskimo) will carry at least three television channels, two in English and one in French, and a multiplicity of communications channels, including telephone and data transmission. Telesat Canada, a private-public corporation created by the Canadian Parliament, already has 13 customers, including the Canadian Broadcasting Corp. and the Bell Telephone Co. of Canada.

One of the main objectives of the new system is to serve the far north and the Arctic islands where wire communi-

cations are impossible because of the distances and rugged terrain, ordinary radio communication is often unreliable, and television is non-existent.

## Laser beam used in new image transmission system

By using a laser beam to burn thousands of holes in a thin bismuth coating over a transparent plastic film, Bell Labs scientists have devised a way of making microfilm copies of photographs, printed copy or other graphic material transmitted from distant points.

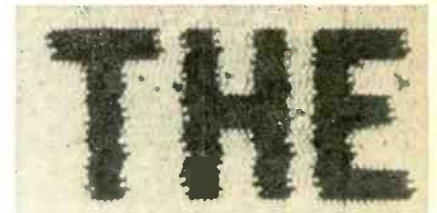

THE WORD "THE" is made by leaving areas untouched by the laser beam, while burning off practically all the bismuth on other parts of the film. Individual holes may be seen around the borders of the individual letters. By simply reversing the modulation signal, the THE could also be white letters on black background.

The system uses a laser beam pulsed at a million pulses per second, to burn holes in a bismuth coating less than three millionths of an inch thick, deposited on a transparent Mylar plastic. Portions of the plastic not touched by the laser beam block 99 per cent of any incident light; the holes pass 80 per cent of the light falling on them.

As shown in the photograph, the holes are formed in a dot pattern somewhat like a halftone photograph in this magazine. The laser beam is scanned across the film by a small vibrating mirror to make the rows of holes. If no power is applied to the beam, the bismuth is left intact. As power is varied, the beam burns larger or smaller holes. Thus a wide range of gray tones can be produced. The film can be used in a slide projector to make a large image on a movie screen. Either printed pages or reproductions of photographs can be projected.

The system may make possible a high-speed, low-cost terminal for receiving data from a computer, or for obtaining information from remote files or records. A typical newspaper page can

(continued on page 16)

# Earn Your Electronics DEGREE by studying at home.

Grantham School of Engineering specializes in teaching electronics and supporting subjects, mainly by correspondence. The School is authorized under the laws of the State of California to grant academic degrees, and is approved under the G.I. Bill.

The A. S. E. T. Degree is offered in four "correspondence semesters" plus a two-week residential seminar. Then, the B. S. E. E. Degree is obtainable through further residential training in engineering subjects and transfer credits in the humanities. For complete information, write for our free **BULLETIN R-73.**

## **GRANTHAM** School of Engineering

1505 N. Western Avenue  
Hollywood, CA 90027

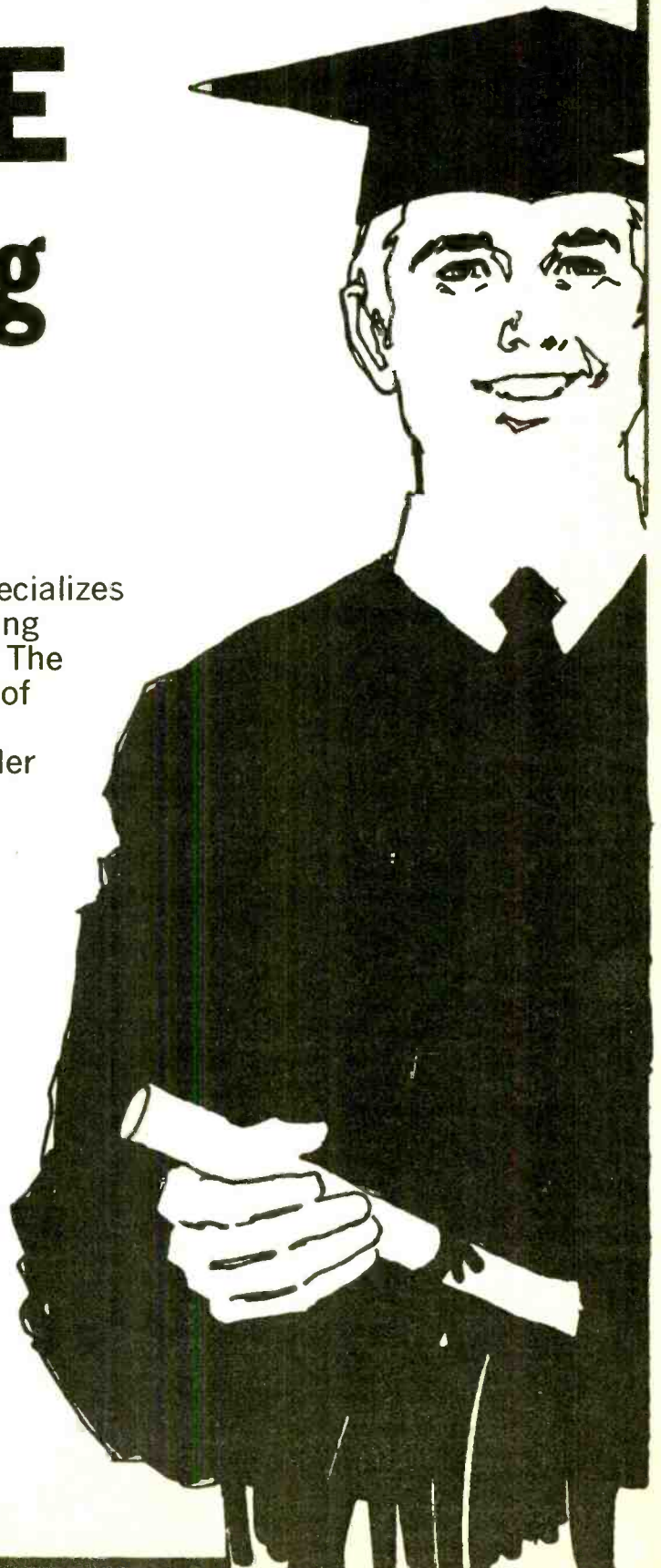

Circle 7 on reader service card

Either way  
you get the  
world's first  
universal  
four-channel  
decoder.



EVR-4X4  
Four-Channel  
AM/FM Receiver  
\$249.95

EVX-44  
Universal  
Four-Channel  
Decoder \$99.95

Now Electro-Voice offers our new universal decoder circuit built into both a stereo receiver and a 4-channel decoder.

The EVR-4X4 Receiver has every needed feature for 2- and 4-channel sound. Yet it costs no more than many 2-channel units that offer half the pleasure. And it will properly decode any matrix 4-channel input without switching. Ideal for playing SQ\*, Stereo-4†, or any other matrixed records, tape, or FM sources.

The EVX-44 Universal Decoder creates a 4-channel control center for existing stereo equipment. Just add a second stereo amp and two more speakers. Unique separation enhancement circuit automatically adjusts front-back separation as required by program material.

Both the receiver and the decoder are also designed to accommodate 'discrete' inputs like 8-track tape if you wish. Hear the finest in four-channel sound at your Electro-Voice showroom. Where the excitement is!

E-V 4-channel products are produced under U.S. Patent No. 3,632,886  
\*T.M. CBS, Inc.  
†T.M. Electro-Voice, Inc.

**Electro-Voice**

a Gulton  
COMPANY

**ELECTRO-VOICE, INC., DEPT. 234E**

#13 Cecil Street, Buchanan, Michigan 49107  
In Europe: Electro-Voice, S. A., Römerstrasse 49, 2560 Nidau, Switzerland  
In Canada: EV of Canada, Ltd., Ontario

Circle 8 on reader service card

# new & timely (continued from page 14)

be transmitted in four seconds over a high-capacity transmission channel, or in about four minutes over an ordinary telephone line.

## First TV repair co-op

Now open in New York City The Grand Street Consumers Cooperative Society is new. R-E Special report next month.

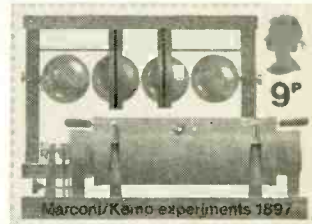
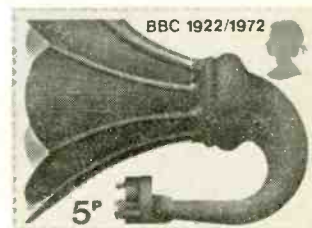
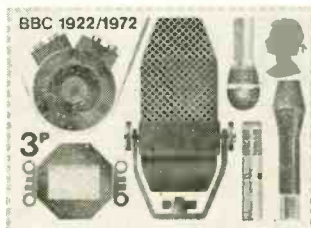

FOUR BRITISH STAMPS COMMEMORATE the 50th anniversary of broadcasting by the British Broadcasting Co. and the 75th anniversary of the experiments by Marconi and George Kemp that resulted in the successful radio test over water in 1897. The 3-penny stamp shows six types of microphones used in broadcasting from 1922 to the present. The 5-penny stamp pictures the Amplion loudspeaker, famous in the mid-'20's. A modern television camera is featured on the 7 1/2-penny stamp, and the 9-penny stamp shows radio equipment used in 1897 for the 9-mile transmission across Bristol Channel.

R-E

Radio-Electronics is published by Gernsback Publications, Inc. 200 Park Ave. S. New York, N.Y. 10003 (212) 777-6400  
President: M. Harvey Gernsback  
Secretary: Bertina Baer

### ADVERTISING SALES

**EAST**  
Stanley Levitan, Eastern Sales Mgr.  
Radio-Electronics  
200 Park Ave. South  
New York, N.Y. 10003  
(212) 777-6400

**MIDWEST/Texas/Arkansas/Okla.**  
Ralph Bergen  
The Ralph Bergen Co.  
6319 N. Central Ave.  
Chicago, Ill. 60646  
(312) 792-3646

**PACIFIC COAST/Mountain States**  
Jay Eisenberg  
J.E. Publishers Representative Co.,  
8560 Sunset Blvd.,  
Suite 601,  
Los Angeles, Calif. 90069  
(213) 659-3810  
420 Market St.,  
San Francisco, Calif. 94111  
(415) 981-4527

**SOUTHEAST**  
E. Lucian Neff Associates  
25 Castle Harbor Isle,  
Fort Lauderdale, Florida 33308  
(305) 566-5656

## MOVING?

Don't miss a single copy of **Radio-Electronics**. Give us:

Six weeks' notice

Your old address and zip code

Your new address and zip code

ATTACH  
LABEL  
HERE

name (please print)

address

city state zip code

Mail to: Radio-Electronics  
SUBSCRIPTION DEPT., BOULDER, COLO.  
80302



# 51,000 replacements can't be wrong when you go by the book.

Gives the data you need to replace today's most used solid-state devices with only 156 RCA SK s. For example, SK 3004, alone, replaces over 4,000 types.

RCA's "SK Replacement Guide" is the book to go by when you need a solid-state replacement. It not only cross-references the top-quality SK line with over 51,000 types, both foreign and domestic, but also supplies the kind of specific application information you need to choose the best replacement. It even includes a comprehensive Quick Selection Replacement Chart to save you time

and trouble when the device you want to replace is not identifiable.

You can be sure the devices that SKs replace so easily are not merely the off-beat kind. They're the ones you are most likely to encounter in your everyday servicing work. For example, the SK line not only offers the largest variety of matched audio pairs but also provides full coverage of TV deflection systems as well as

RF and Video stages. Add to this a full line of diodes and broad coverage of ICs and you see why so many service technicians go the SK way. It's "The Solid State System" that reduces your inventory needs and builds customer satisfaction.

Contact your RCA Distributor today for the full SK story, and get the latest copy of the RCA SK Replacement Guide SPG-202N. You'll see why you can't go wrong with RCA SKs.

RCA I Electronic Components  
Harrison, N.J. 07029.

**RCA** Electronic Components



Circle 9 on reader service card

# Changes come fast in electronics.

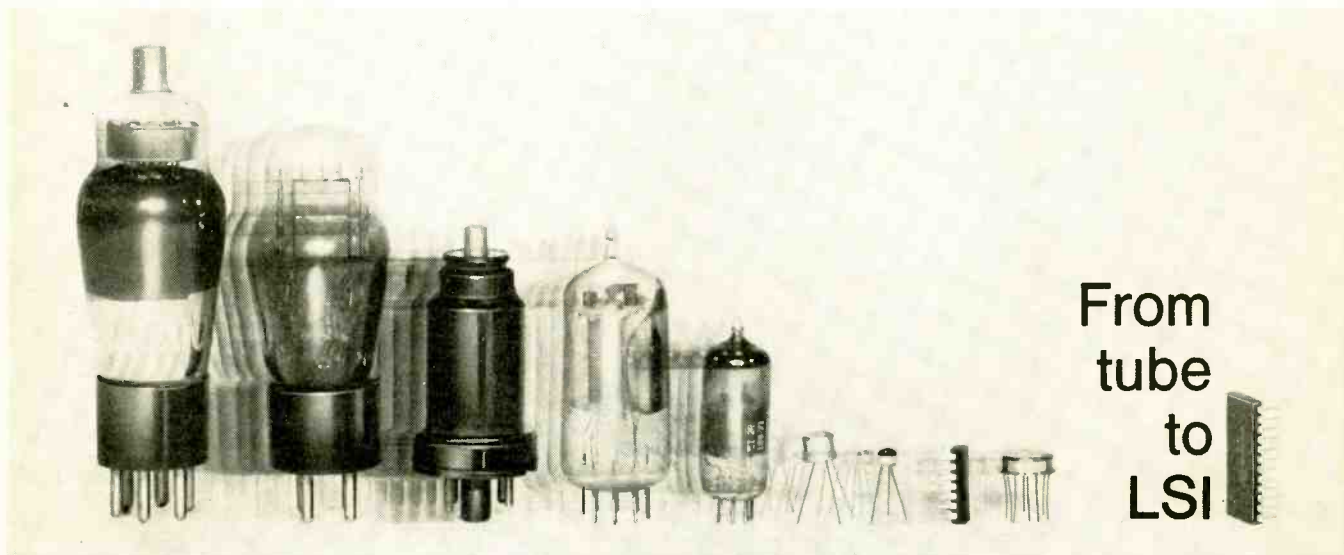

From  
tube  
to  
LSI

Take a look at the race in circuit technology. In the 1960's the tubes at the left made way for the transistors at the right. Today, transistors are surpassed by the large scale integrated circuit (LSI) at the far right. This circuit, less than a quarter inch square, replaces over 6000 transistors!

There's big money to be made by the men who stay ahead of this technology race. Put yourself

ahead with NTS Home Training! You get the latest, most advanced equipment (at no extra cost). More solid-state units, and more advanced technology. Plenty of training with integrated circuits, too! As an NTS graduate, you enter a world of electronics you're familiar with. You have a thorough working knowledge of solid-state circuitry. You're ready to tackle bigger jobs at higher pay!

## NTS COLOR AND B & W TV SERVICING

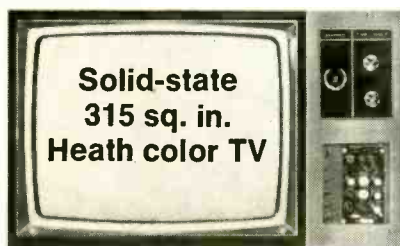

**Solid-state  
315 sq. in.  
Heath color TV**

Build and keep the largest, most advanced color TV made! Over-all solid-state design, ultra-rectangular screen, matrix picture tube, built-in self-servicing features, "Instant On," A.F.T., solid-state, 24-channel detent UHF/VHF power tuning, and much more! Also build and keep AM-SW Radio, Solid-State Radio, FET Volt-Ohmmeter, and Electronic Tube Tester. Learn trouble-shooting, hi-fi, stereo, multiplex systems, radio, color and B & W TV servicing.

Learn sophisticated solid-state circuitry as you build this B & W TV receiver. Lo-Silho "Superhet" Radio, FET Volt-Ohmmeter, Solid-State Radio, Electronic Tube Checker, and Signal Generator. TV

and all other equipment are yours to keep.

**Solid-state  
B & W TV,  
74 sq. in.  
picture  
(cabinet  
included)**

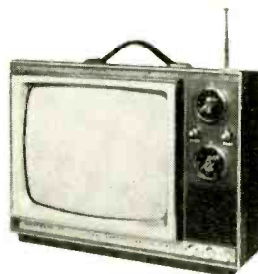

## NTS ELECTRONICS & COMPUTER TECHNOLOGY

Build and keep this exclusive NTS Compu-Trainer. It teaches you the

**Solid-state  
Compu-Trainer  
14 integrated  
circuits replace  
198 transistors!**

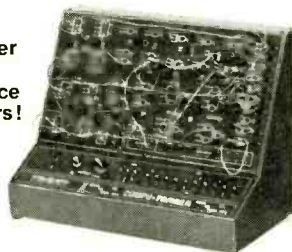

same principles used in million-dollar systems. Contains 14 inte-

grated circuits! All Solid-State! You perform all wiring and patchcording. No shortcuts. No pre-wired circuit boards. Your training is complete! Also receive an FET Volt-Ohmmeter and a 5" wide-band Solid-State Oscilloscope.

## NTS ELECTRONICS COMMUNICATIONS

Gain the prestige and earning power of owning an F.C.C. First Class Radio-Telephone License. Two comprehensive NTS courses cover the big opportunity field of transmitting and receiving.

You build and keep 14 kits, including this amateur phone 6-meter VHF Transceiver, NTS's exclusive 6-transistor Solid-State Radio, and a fully transistorized Volt-Ohmmeter. Also, learn 2-way radio, Citizens Band microwaves, and radar.

**5-watt AM  
transmitter/  
receiver**



# NTS Home Training puts you in the lead.

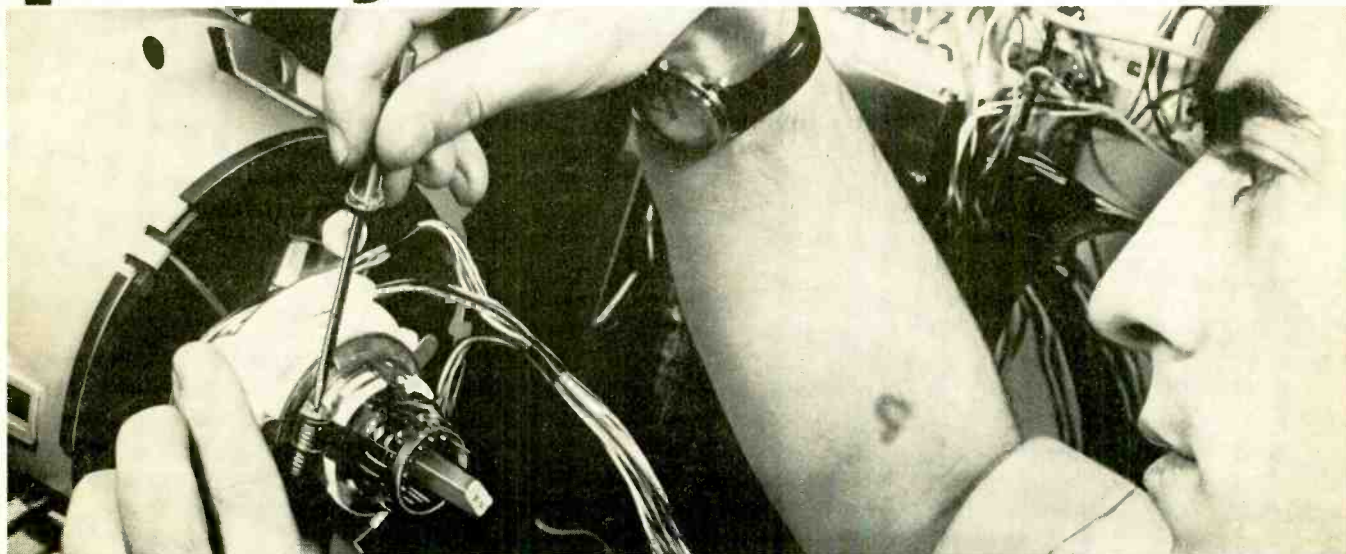

## NTS INDUSTRIAL & AUTOMATION ELECTRONICS

Automation is the future of industry and you can play an important part! Learn industrial controls by training on the NTS Electro-Lab (a complete workshop). You also build and operate this 5" Solid-State oscilloscope. And you perform experiments that involve regulating motor speeds, temperature, pressure, liquid level, and much more. All equipment is yours to keep.

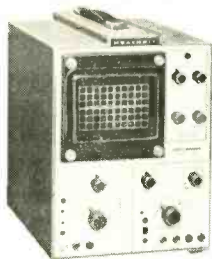

## NTS AUDIO ELECTRONICS SERVICING

Learn basic sound theory—how it works in home radio, car tape

decks, stereo multiplex component systems, and more! Set up a spectacular music system. Learn about



Build and keep this famous Heath Stereo Receiver and Speakers.

sound distortion, amplification and control, loud-speaker baffles, problems of system installation, etc. Included is Volt-Ohmmeter, In-Circuit Transistor Tester, and Solid-State

Radio. Prepare yourself for great opportunities in the Home Entertainment Industry!

## CLASSROOM TRAINING AT LOS ANGELES

You can take classroom training at Los Angeles in sunny Southern California. NTS occupies a city block with over a million dollars in technical facilities. Check box in coupon below.

## NATIONAL TECHNICAL SCHOOLS

WORLD-WIDE TRAINING SINCE 1905  
Resident & Home Study Schools  
4000 S. Figueroa Street  
Los Angeles, California 90037

## APPROVED FOR VETERANS

Accredited Member: National Association of Trade and Technical Schools; National Home Study Council.

Big, Colorful NTS Guide to new opportunities in Electronics. Yours FREE!



NATIONAL TECHNICAL SCHOOLS  
4000 S. Figueroa Street  
Los Angeles, California 90037

Please rush me FREE Color NTS Electronics Guide & FREE lesson, plus information on course checked at right. No obligation. No salesman will call.

- MASTER COURSE IN COLOR TV SERVICING
- COLOR TV SERVICING (FOR ADVANCED TECHNICIANS)
- MASTER COURSE IN B&W TV & RADIO SERVICING
- MASTER COURSE IN ELECTRONIC COMMUNICATIONS
- PRACTICAL RADIO SERVICING
- FCC LICENSE COURSE
- MASTER COURSE IN ELECTRONICS TECHNOLOGY
- AUTOMATION & INDUSTRIAL ELECTRONICS
- COMPUTER ELECTRONICS
- BASIC ELECTRONICS
- AUDIO ELECTRONICS SERVICING

Dept. 206-023

NAME \_\_\_\_\_ AGE \_\_\_\_\_

ADDRESS \_\_\_\_\_

CITY \_\_\_\_\_

STATE \_\_\_\_\_ ZIP \_\_\_\_\_

- Check if interested in Veterans Training under new G.I. Bill.
- Check if interested ONLY in Classroom Training at Los Angeles

# What makes Crown products UNIQUE ?

People often ask us what makes Crown products so different. To begin with, Crown is a professional audio equipment manufacturer, although we also serve discriminating audiophiles. Then there are other unique differences which you may not be aware of.

Crown craftsmen work to only one quality level. Models differ in size and features but not quality. Each is designed to be superior in overall performance in its price range. For example, no competitive amplifier, preamplifier or tape recorder can match Crown's distortion levels. Crown products are made only in America, by American craftsmen with 99% American parts.

Every Crown is guaranteed to meet or exceed printed specifications. Ratings given are always for minimum performance levels. For example, the DC300 is rated at 150 watts per channel rms at 8 ohms, although it typically delivers 300 watts per channel rms with 4 ohms.

Each active electronic component is tested before wiring, then each circuit board is tested after wiring, and finally, the complete product is tested from every angle. All in all, a tape recorder undergoes more than 100 hours cumulative testing. Finally, every Crown is accompanied by its individual hand-entered proof-of-performance report.

All this in-plant effort is backed up in the field by broad-service warranties. This is not to make the products "look good" in advertising, but because we feel committed to keeping every product serving its owner satisfactorily. Amplifiers and preamplifiers are covered by a three-year warranty on parts, labor and round-trip shipping. In addition, all warranties cover continuous commercial usage, including broadcast use 18 hours a day, 7 days a week for years. This is extremely rare for hi fi products, but it confirms the fact that Crown products are designed to the professional standards demanded by recording studios, research and design laboratories, professional musicians, etc.

Among the professional features which ensure the least possible deterioration are front panels of 3/16" aluminum plate, corrosion-protected metal parts, wear-proof control markings, silicon transistors, tantalum capacitors, and many other top-grade components selected for maximum life.

Crown does not plan for product obsolescence. The design lifetime of a Crown recorder is ten years or 65,000 hours, with three service overhauls. We have not yet found performance deterioration in any amplifier after six years in the field.

As one of the oldest audio manufacturers selling in the high fidelity market, we at Crown emphasize that our primary goal is not to make sales, but to serve our customers as we would want to be served, with factual advertising, genuine product value and courteous customer service. For us, this is a deeply satisfying way of doing business.



# letters

## OPEN LETTER FOR ALL SERVICE TECHNICIANS

We are becoming very concerned with attitudes of many elected persons on consumer problems. It quite obviously has become the "in thing" to cast blanket condemnation upon entire phases of business. We hear at accelerating incidence, references by these people to ALL TV-radio service people being racketeers. Were this to be a fact, at least we could take consolation in a posh life style while being driven from bank to bank by our chauffeurs in our Cadillacs.

The most galling new aspect is justification of any and all rash charges by the politicians, with the statement, "Bess Myerson said so." This classic hiding behind a skirt by elected officials, using unfair and non-productive tactics, is quite abhorrent and cannot be tolerated.

The enclosed letter to Miss Myerson we hope will give her information on facts of TV service business life that will eliminate excuses for the would-be do-gooders.

Miss Bess Myerson  
Department of Consumer Affairs  
80 Lafayette Street  
New York, New York 10013  
Dear Miss Myerson:

We are getting from consumerism oriented elected officials what we are sure are distortions of your statements. We speak only for the TV-home electronics servicer. The usual approach is that almost all TV-radio technicians are totally dishonest and then in lieu of personal investigation, they try to justify their statements by saying in effect, "Bess Myerson says so."

This we believe is a perversion of what you are trying to do and serves NO honest purpose.

When a person without knowledge of a given business dealing with a highly complex product, attempts to arbitrarily determine cost and practices, he does a serious disservice to the public he claims to be protecting.

First, TV, and particularly solid-state color TV, is the most complex device in the home. The technology changes so rapidly that the service people "must run just to stand still" and so to expect a set owner to understand it, is idiotic.

Second, price of sets is predicated on the fact that most sets in total or at least major sections of it, has been automatically produced by foreign labor, most of it at \$30.00 to \$40.00 per week.

Third, service of ALL sets of necessity is a custom operation because of multiplicity of models, and a great variety of trouble symptoms, many of which can be caused by a number of distinctly different troubles. This work can be performed properly only by well trained technicians, all of whose costs are based upon American standards rather than Oriental or other depressed standards.

Fourth are the myths that the defective product is small or was bought at a bargain. These factors actually add to cost of service because smallness congests circuitry and cheap price is due to "stripping down" of components and reduction in safety tolerances.

A major unfair tactic by exposé shoppers is allegation of overcharging for estimates. This is compounded by shoppers who use marginal products and often "cutely" try to confuse the servicer by their explanation of symptoms, even though the injected planted evidence may be as simple as a blown fuse, which trouble if legitimate, could be due to major but possibly intermittent multiple component breakdown. The point generally missed is that a true estimate actually entails an entire correction operation, often requiring at least temporary installation of replacement components to verify correction or to move on past one defect to analyze a second. The degree of service performed depends on the servicer's desire to restore a set to as close to like-new condition, which in many cases, might be beyond the set owner's ability to recall because sets, like auto tires, WEAR OUT gradually.

95% of servicers recognize the set owners' right to determine how far restoration should proceed and so if the set owner says "Just make it work," the cost is far less than a full restoration. Most servicers will give "Guesstimates" for a very reasonable fee of as little as \$5.00, but certainly cannot then be expected to give guarantees of any kind.

We would urge that when shopping, a claim check should be demanded on which restrictions, such as estimate only, be indicated in writing and minimum fee be indicated.

We assure you that most servicers, and certainly members of NATESA, are at least as honest as any segment of business, and that means 95%. They are

*(continued on page 24)*

# Introducing the expensive curve tracer that doesn't cost a lot.

The B&K Model 501A.

It's a lab-quality instrument that provides fast analysis of all semiconductors including J-FET's, MOS-FET's, signal and power bipolar transistors, SCR's, UJT's and diodes.

You can test transistors in circuit for GO/NO GO condition. Badly distorted curves will indicate the stage where a defective transistor or other faulty component exists.

The 501A is complete—with scope graticule and FP-3 probe for fast, one-handed in-circuit testing. It generates true current and voltage steps, with 3% accuracy, for measuring beta at all current levels. And it has a sweep up to 100 volts and 100 milliamperes.

With the 501A, curves are displayed on an auxiliary scope screen. And you can hook it up to any scope—old or new.

All three controls can be set in quick-test positions to test and evaluate 90% of all solid-state devices without manufacturer's data sheets.

The 501A won't burn out either the semiconductors or itself.

With all these features, you'd think the 501A was an expensive curve tracer. But look at the price.

For complete technical data, call your B&K distributor. Or write Dynascan Corporation.

# \$129.95

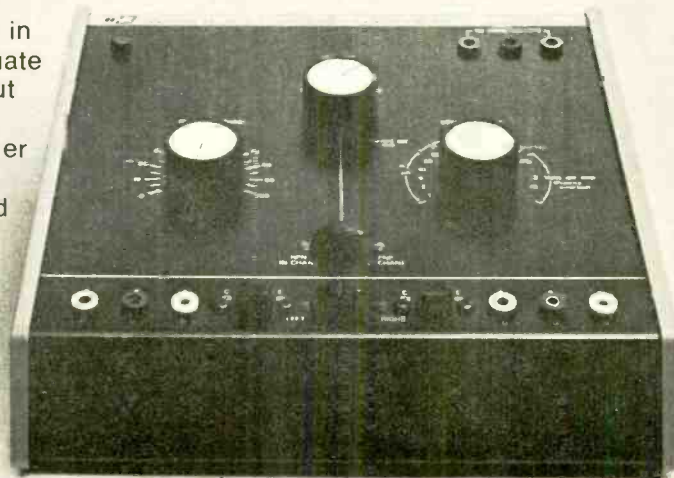

Very good equipment at a very good price. **B&K**

Product of Dynascan Corporation  
1801 West Belle Plaine Avenue, Chicago, Illinois 60613

Circle 11 on reader service card

FEBRUARY 1973 • RADIO-ELECTRONICS 23

# Pix-Mate™ the crt tester you can afford to take along

only ... \$34.95



- A quality CRT tester with individual test for each gun.
- Compare guns for emission.
  - Test for leakage and shorts.
  - Legible 3 color scale.
  - Compact, portable, rugged.
  - Avoid recalls, check the CRT on every call.

WRITE US!

## TeleMatic

take along the time savers

- PIX-MATE • CRY-S-MATE • GEN-MATE
- SOUND-MATE • TRACE-MATE

The Caddy-Mate Line.

2245 PITKIN AVE., BROOKLYN, N. Y. 11207

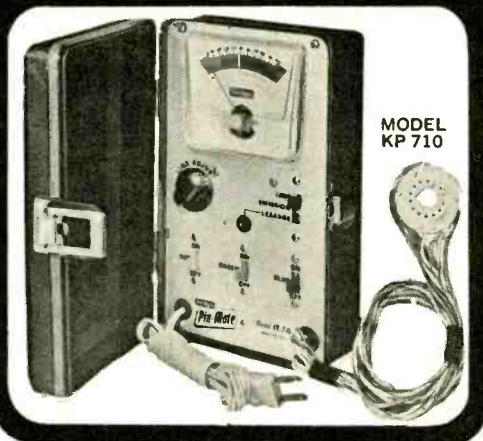

Circle 12 on reader service card

## Why pay an answering service when you can own your own?



Dictaphone has a machine to make sure you never lose another cent through a missed phone call or a garbled message. In fact, we have a whole line of them.

They're called Ansafones. You can buy one outright or possibly lease it for about what you're paying your answering service now. And it works for you 24 hours a day, 7 days a week.

For a free brochure describing how much an Ansafone can help you, mail this coupon now.

**▶ Dictaphone**

Box L-2-34, 120 Old Post Road, Rye, New York 10580  
Please send me full details of the Ansafone line.

Name \_\_\_\_\_

Company \_\_\_\_\_ Phone \_\_\_\_\_

Address \_\_\_\_\_

City \_\_\_\_\_ State \_\_\_\_\_ Zip Code \_\_\_\_\_

Ansafone and Dictaphone are registered trademarks of Dictaphone Corp.

Circle 13 on reader service card

## LETTERS

(continued from page 22)

eager to serve the public because most independents are neighbors of their customers so can't hide from them. It is proven fact that the biggest problem is haphazard selection of service agency and generally at the critical moment of set failure. Expecting impossible bargains and perhaps gimmicks and gifts leads only to "fast pitch" unqualified sharpshooters who, because they continuously lose customers when they finally awaken, must advertise very extensively at cost that obviously is beyond their "hole in the wall" size to justify.

Let us also assure you that NATESA is very consumerism aligned, as the dates on the several enclosures will indicate. We worked with law enforcement and protective agencies during the entire existence of NATESA in the past quarter century. We can identify provable problem areas and problem operators, without maligning the vast numbers of ethical servicers.

N A T E S A

(National Alliance of Television & Electronic Service Associations)

FRANK J. MOCH

Executive Director

5908 S. Troy St.

Chicago, Ill. 60629

For Radio-Electronics editorial viewpoint on this important matter, see page 4 in this issue.

## 4 CHANNEL NOTES

It seems that the discrete/matrix debate is doing strange things to its leaders. In each side's enthusiasm to convince the reading public that the other side is inferior, they let themselves give less and less logical arguments.

Even I could find fallacies in the recent letters in **Radio-Electronics** between Gordon Holt and Peter Scheiber. Writing against discrete 4-channel records, Mr. Scheiber stated that total separation in playback is unnatural, forgetting or ignoring the fact that people who make records don't usually have a certain sound *only* in Channel A, but add a little to Channel B so as to give a stereo panorama instead of two point sources with nothing in the middle between the speakers. What total separation means is the *ability* to have point sources, which musicians and engineers do want occasionally. In his reply, Gordon Holt made a similar mistake when he said that a frequency range past 10,000 Hz is useless. And Gordon Holt returned to argue that down, saying, "Let's not go 4-channel at the expense of *any* of the signal quality possible in the state-of-the-art recording". But separation and tight control of directionality are part of that sig-

(continued on page 89)

# Channel Master's new Spartan Amplifier.

## It knows how to say "NO!"

Antenna amplifiers don't have a good reputation. They just seem to sit up there and attract all kinds of trouble. Channel Master knows that even one callback is too many. And, frankly, we felt that if the industry gave you a more reliable, trouble-free, high-performance amplifier, you'd put up a lot more. That's why we've just engineered a brand new one--the Spartan. It doesn't make problems. It solves them.

**"No" to signal overloading.** The Spartan uses new high-capacity semiconductors that can handle up to 200,000 microwatts of signal without distortion or cross-modulation. No amplifier can beat it.

**"No" to lightning damage.** Lightning surges are the #1 cause of amplifier failure. But now you've got the Spartan. Thanks to advanced new energy-absorbing circuits and components, it takes charge after charge--and still keeps working.

**"No" to FM interference.** It's the only amplifier with 2 built-in FM traps: a switchable filter that attenuates signals 25 dB across the FM band, plus a tunable trap--only 1 MHz wide--that gives you an extra knockout punch exactly where you need it.

**"No" to tropical heat, sub-zero cold, and pouring rain.** Exceptional stability and reliability in any kind of weather. And it maintains its flat gain, with no oscillation or hum, even when line voltages fluctuate.

CHANNEL MASTER

**CHANNEL MASTER**  
**SPARTAN SERIES**  
**ANTENNA AMPLIFIERS**  
**...for guys who**  
**can't afford trouble!**

75 and 300 ohm models for every reception area. Write for technical literature.

CHANNEL MASTER  
DIV. of AVNET, INC.  
Ellenville, N.Y. 12428



Circle 14 on reader service card

**Now... the most enjoyable,  
do-it-yourself project  
of your life—a Schober  
Electronic Organ!**

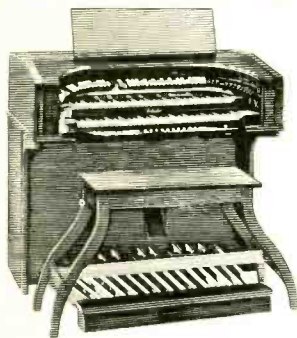

You'll never reap greater reward, more fun and proud accomplishment, more benefit for the **whole family**, than by assembling your own Schober Electronic Organ.

**You need no knowledge of electronics, woodwork or music.** Schober's **complete** kits and crystal-clear instructions show **you** — whoever you are, whatever your skill (or lack of it) — how to turn the hundreds of quality parts into one of the world's most beautiful, most musical organs, worth up to twice the cost of the kit.

Five superb models with kit prices from \$500 to around \$2,000, each an **authentic musical instrument actually superior to most you see in stores**, easy for any musically minded adult to learn to play, yet completely satisfying for the accomplished professional. And there are accessories you can add any time after your organ is finished — lifelike big auditorium reverberation, automatic rhythm, presets, chimes, and more.

Join the thousands of Schober Organ builder-owners who live in every state of the Union. Often starting without technical or music skills, they have the time of their lives — first assembling, then learning to play the modern King of Instruments through our superlative instructions and playing courses.

Get the full story **FREE** by mailing the coupon **TODAY** for the big Schober color catalog, with all the fascinating details!

The *Schober* Organ Corp., Dept. RE-111  
43 West 61st Street, New York, N. Y. 10023

Please send me Schober Organ Catalog.

Enclosed please find \$1.00 for 12-inch L.P. record of Schober Organ music.

NAME \_\_\_\_\_

ADDRESS \_\_\_\_\_

CITY \_\_\_\_\_ STATE \_\_\_\_\_ ZIP \_\_\_\_\_

Circle 15 on reader service card

# equipment report

*Aries pocket calculator kit  
from B&F*



Circle 26 on reader service card

DESIGNED AROUND A 40-PIN DUAL-IN-LINE-plastic encapsulated integrated circuit, the Aries pocket calculator is a four-function machine that displays its answers on an eight-digit LED display. It uses floating-point arithmetic so the decimal point is always positioned to give a maximum of significant figures in the calculated result. A "K" switch stores an entered constant in a memory register so it can be recalled by the machine to be multiplied by, divided into, added to, or subtracted from in a series of chain calculations. These calculators are great for doing all kinds of jobs from balancing checkbooks to doing homework. The slide-rule has passed its heyday and soon will become extinct due to this modern gift of the electronics industry.

The Aries calculator is made up of three circuit boards; the main board, the clock/power supply board and the keyboard. From the outset it is clear that this is not a kit of beginners and will draw on the skills of the more experienced. It takes a great deal of precision and patient care to mount the components onto the fine board foil patterns. While the instructions are not highly detailed they are adequate for the experienced kit builder. Before beginning construction

I recommend the following three items as pre-requisites: 1. A good magnifying glass or low-power microscope to inspect the connections. 2. A high-grade fine-tipped tweezers to assist in positioning leads, particularly those of the LED displays. 3. A spray can of flux remover to clean the boards after soldering to allow a careful inspection.

(The problem of possible damage to the fine LED leads has been eliminated. Kits produced now have the 8-digit readout as one composite unit.—*Editor*)

Assembly proceeds by mounting the components on the boards, interconnecting the boards, wiring the battery supply and the final mechanical case assembly. Mounted on the main board are the eight LED displays, the LED negative and overrange indicators, the 40-pin IC, the 26 display driver transistors with their associated resistors, and two slide switches. The smaller clock/power supply board generates the dual phase 25-kHz clock and the -4.8- and +2-volt supplies required by the chip. The negative supply is taken directly off the batteries while the positive voltage is derived by rectifying the clock signal. The third board, the keyboard, is a clever economical printed-circuit affair that outperformed my expectations. The keyboard contacts are printed-circuit foil, bridged by a conductive rubber pad. The pad is separated from the board by a plastic mask with cutouts corresponding to the various keys.

Construction time was about 10 hours followed by an hour of troubleshooting. At first one digit did not light due to a resistor that was damaged during assembly (my fault). After replacing the resistor it was possible to enter numbers but not perform any of the four functions. You begin to feel quite helpless after realizing the defect may be out of reach on the chip. The feeling was soon dissipated by finding a cold solder joint at one of the IC terminals (my fault again) and with a touch of the iron the calculator sprang to life.

Operation of the calculator is  
*(continued on page 88)*



# Another introductory offer to new members of the ELECTRONICS AND CONTROL ENGINEERS' BOOK CLUB

	404/445 <b>ELECTRONIC CIRCUITS MANUAL</b> by J. Markus Pub. price, \$19.75 Club price, \$15.75		286/515 <b>INTEGRATED CIRCUITS: A Basic Course for Engineers and Technicians</b> by R. G. Hibberd Pub. price, \$9.95 Club price, \$8.45
	637/458 <b>DESIGNING WITH TTL INTEGRATED CIRCUITS</b> by Texas Instruments Inc. Pub. price, \$18.50 Club price, \$13.50		162/212 <b>INTEGRATED CIRCUITS &amp; SEMI-CONDUCTOR DEVICES</b> by Deboo & Burrous Pub. price, \$13.95 Club price, \$10.50
	404/437 <b>SOURCEBOOK OF ELECTRONIC CIRCUITS</b> by J. Markus Pub. price, \$19.75 Club price, \$14.75		313/059 <b>HANDBOOK OF SEMI-CONDUCTOR ELECTRONICS, 3/e</b> by P. Hunter Pub. price, \$27.50 Club price, \$21.50
	259/607 <b>COMMUNICATION SYSTEM ENGINEERING HANDBOOK</b> by D. H. Hamsher Pub. price, \$29.50 Club price, \$22.50		558/140 <b>ELECTRONIC COMPUTER TECHNOLOGY 2/e</b> by N. R. Scott Pub. price, \$18.00 Club price, \$13.75
	139/296 <b>AMERICAN ELECTRICIANS HANDBOOK</b> by Croft, Carr & Watt Pub. price, \$22.50 Club price, \$18.25		124/035 <b>HANDBOOK OF PHYSICS, 2/e</b> by Condon and Odishaw Pub. price, \$34.75 Club price, \$14.95
	109/32X <b>ELECTRONICS IN INDUSTRY 4/e</b> by Chute & Chute Pub. price, \$13.95 Club price, \$10.75		283/672 <b>INSTRUMENTS &amp; MEASUREMENTS FOR ELECTRONICS</b> by C. N. Herrick Pub. price, \$13.95 Club price, \$10.50
	649/170 <b>OPERATIONAL AMPLIFIERS</b> by Tobey, Graeme & Huelsman Pub. price, \$15.00 Club price, \$11.50		209/731 <b>STANDARD HANDBOOK FOR ELECTRICAL ENGINEERS, 10/e</b> by Fink and Carroll Pub. price, \$32.50 Club price, \$24.95

**ANY ONE**  
of these great professional books  
for only **\$1.00**  
VALUES FROM \$9.95 to \$34.75

Special \$1.00 bonus book comes to you with your first club selection

## Save time and money by joining the Electronics and Control Engineers' Book Club

HERE is a professional club designed specifically to meet your day-to-day engineering needs by providing practical books in your field on a regular basis at below publisher prices.

**How the Club operates:** Basic to the Club's service is its publication, the *Electronics and Control Engineers' Book Club Bulletin*, which brings you news of books in your field. Sent to members without cost, it announces and describes in detail the Club's featured book of the month as well as alternate selections which are available at special members' prices.

When you want to examine the Club's feature of the month, you do nothing. The book will be mailed to you as a regular part of your Club service. If you prefer one of the alternate selections—or if you want no book at all for that month—you notify the Club by returning the convenient card enclosed with each *Bulletin*.

As a Club member, you agree only to the purchase of four books over a two-year period. Considering the many books published annually in your field, there will surely be at least four that you would want to own anyway. By joining the Club, you save both money and the trouble of searching for the best books.

### MAIL THIS COUPON TODAY

**ELECTRONICS AND CONTROL ENGINEERS' BOOK CLUB**  
582 Princeton Road, Hightstown, N.J. 08520

Please enroll me as a member of the Electronics and Control Engineers' Book Club and send me the two books indicated below. I am to receive the bonus for just \$1.00, and my first selection at the special Club price shown. These books are to be shipped on approval, and I may return them both without cost or further obligation. If I decide to keep the books, I agree to purchase as few as four books during the next two years at special Club prices (at least 15% below list).

Write Code No. of  
bonus book  
here

Write Code No. of  
first selection  
here

Name \_\_\_\_\_

Address \_\_\_\_\_

City \_\_\_\_\_

State \_\_\_\_\_ Zip \_\_\_\_\_

E 33202

Circle 16 on reader service card

# USE IT ALL AS YOU GET READY FOR A NEW CAREER...

## \$1,500.00 worth of two-way radio electronic communications equipment!

Bell & Howell Schools announces a new learn-at-home program that gives you "hands on" experience with commercial-grade equipment—as you prepare for a business of your own in two-way radio electronic communications servicing.

You need "hands on" experience with a real, commercial-band FM transceiver and actual commercial-grade test equipment—to take full advantage of growing opportunities in electronic communications.

Two-way radio communications is a healthy growth area in electronics. And it's lucrative. Almost two million commercial two-way radio systems now serve as vital communications links for trucks, planes, boats and taxis. And the FCC requires each system to have its equipment serviced regularly by a licensed technician. That's where you come in. But you need career-oriented training—plus your FCC license.

Knowing how to put an amateur radio kit together won't help when you're "on the job"—servicing two-way radio systems for aircraft or advising trucking companies about their land-mobile communications system. For that, you need "hands on" experience with the real thing. This unique new Bell & Howell Schools learn-at-home program that gives you just that. You can work with the equipment by attending one of our special "help sessions" or by dropping by one of the Bell & Howell resident schools. If neither of these plans

is convenient, you can have the equipment shipped to your home in return for a \$100 deposit, which is refundable when you return the equipment.

Find out more about this exciting new Bell & Howell Schools program. There's no obligation.

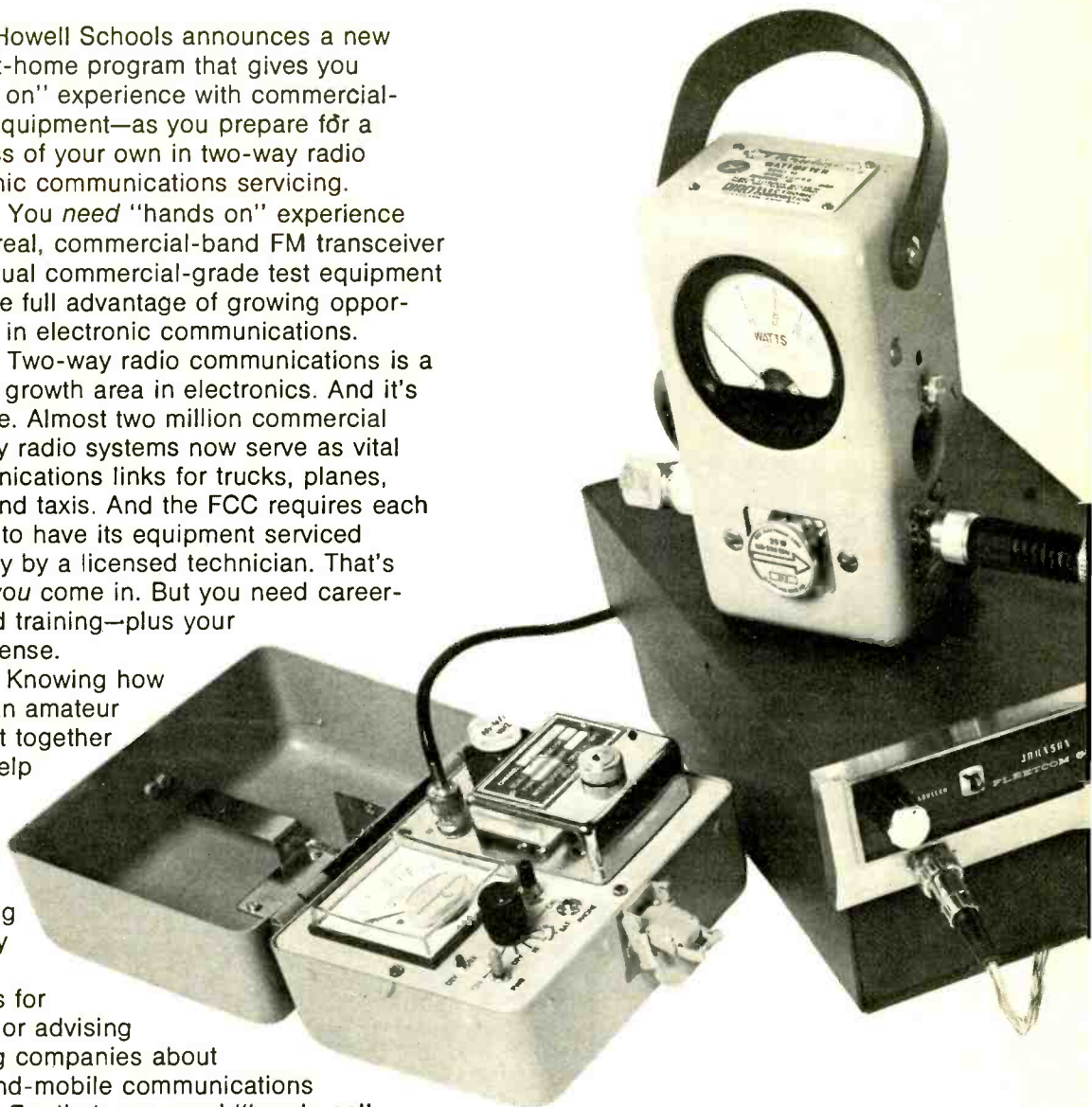

**For free facts, mail attached card today!**

# Let Bell & Howell Schools help you get ready for an exciting career or business of your own in two-way radio electronic communications!

Bell & Howell Schools has helped thousands of people prepare for careers—and businesses of their own—in electronics. You can have absolute confidence in the thorough training you get.

Expert instructors at Bell & Howell Schools plan each program to answer a single question: "What qualifications will you need to take advantage of *actual career opportunities* in electronics?" They then build each program to give you those exact qualifications.

To get ready for a business of your own in two-way radio, you need: 1) career-oriented training; 2) FCC License; 3) "hands on" experience with commercial-grade equipment. Bell & Howell Schools now offers this new at-home training program that gives you all three. (See FCC License Guarantee on attached card.)

## JUST LOOK AT ALL THE EQUIPMENT YOU'LL WORK WITH DURING YOUR TRAINING PROGRAM WITH BELL & HOWELL SCHOOLS!

*Commercial-Band FM Transceiver* . . . exactly the kind of two-way radio you'll service throughout your career



### *Deviation Meter*

. . . model favored by many working technicians to check modulation of transmitted signal.

### *Frequency Meter*

. . . highly sensitive instrument used to check signal frequency within precise tolerances established by government standards.

### *Power Output Meter*

. . . meter used almost universally by trained and licensed technicians to check power output—or wattage—of signal.

### *Alignment Generator*

. . . a custom-designed unit you use to generate test signals for transceiver alignment.



## FCC REGULATIONS GIVE YOU THE OPPORTUNITY TO START YOUR OWN BUSINESS!

The Federal Communications Commission requires that all commercial two-way communications systems be checked and serviced by a licensed technician at regular intervals.

As a Bell & Howell Schools graduate, you'll have the technical know-how you need. With your FCC license, you can go out and eventually build your own business—signing contracts with companies that use two-way radio. FCC regulations could mean security and regular income for you!

## BELL & HOWELL SCHOOLS OFFERS YOU THESE SPECIAL ADVANTAGES:

*Help Sessions* Scheduled regularly every few Saturdays at the Bell & Howell Schools and in many other cities throughout the U.S. and Canada. Top instructors give you personal help and guidance.

*Transfer Privileges* After completion, you can transfer to any of the resident schools for more advanced study, if you wish.

*Lifetime National Placement Assistance* Helps you locate a job where you want to anytime after you complete program.

*Veterans' Benefits* We are approved by the state approval agency for Veterans' Benefits.

*Student Financial Aid* We are an eligible institution under the Federally Insured Student Loan Program.

## EXCLUSIVE ELECTRO-LAB®—YOURS TO KEEP!

To make sure you get practical experience with instruments used daily by professionals, we've integrated into your program three precision instruments you assemble yourself and keep:

*Design Console* Use this to rapidly "breadboard" circuits without soldering.

*Oscilloscope* Offers bright, sharp screen images, 3-way jacks for leads, plugs.

*Transistorized Meter* Registers current, voltage and resistance.

## FOR FULL INFORMATION, MAIL THE ATTACHED CARD TODAY! OR WRITE:

An Electronics Home Study School  
DEVRY INSTITUTE OF TECHNOLOGY



ONE OF THE  
**BELL & HOWELL SCHOOLS**  
4141 Belmont, Chicago, Illinois 60641

406 R

# LOW COST DIGITAL KITS

**NEW BIPOLAR MULTIMETER:  
AUTOMATIC POLARITY INDICATION**



## Model ES 210K

Displays Ohms, Volts or Amps in 5 ranges  
Voltage from 100 Mv to 500 V • Resistance  
from 100 Ohms to 1 Megohm • Current from  
100 Micro Amps to 1 Amp ..... \$77.00  
Case extra: \$12.50 (Optional probe) \$ 5.00

## DIGITAL FREQUENCY COUNTER:



ES 220K — Line frequency time base. 1 KHz  
resolution. 5 digit: \$69.50 Case extra: \$10  
ES 221K — Crystal time base. 100 Hz resolu-  
tion. 6 digit: \$109.50 Case extra: \$10.00

## DIGITAL CLOCK:



ES 112K/124K • 12 hr. or 24 hr. clock \$46.95  
Case extra: Walnut \$12.00 • Metal \$ 7.50

Dependable solid state components and circuitry.  
Easy reading, 7 segment display tubes with clear,  
bright numerals. These products operate from 117  
VAC, 60 cycles. No moving parts. Quiet, trouble free  
printed circuit.

Each kit contains complete parts list with all parts,  
schematic illustrations and easy to follow, step by  
step instructions. No special tools required



**ORDER YOURS TODAY:**  
Use your Mastercharge or  
BankAmericard  
Money Back Guarantee

506 Main St., El Segundo, Ca. 90245  
(213) 772-6176

Circle 17 on reader service card

# equipment report

## Onkyo TX-666 Solid-state stereo receiver



Circle 27 on reader service card

OUTSTANDING IN BOTH ELECTRICAL and mechanical construction and design the Onkyo TX-666 is obviously the result of attention to detail. Tuning the AM and FM bands with 40- and 1.8-microvolt sensitivities respectively, it delivers 60 watts of rms power to each of two 4-ohm speakers. If you are impressed with even bigger numbers this amounts to 200 watts IHF power. With 8-ohm speakers the output is reduced somewhat to 50 watts rms per channel.

FM image rejection is better than 70 dB, i.f. rejection ratio 100 dB and signal-to-noise ratio 60 dB as a result of a 4-gang capacitor/FET front-end combined with three pairs of ceramic i.f. filters. The remaining pertinent FM specifications are 50 dB minimum AM rejection, 0.5 dB capture ratio, 0.5% stereo distortion (0.2% mono), and 40 dB separation at 400 Hz. Total harmonic and intermodulation distortion are held below 0.2% and 0.3% respectively. At 1-watt frequency response is 10-40,000 Hz  $\pm 1$  dB with a power bandwidth of 10-40,000 Hz, IHF THD 0.2%. Bass and treble controls have an adequate  $\pm 10$  dB range.

AM performance is also enhanced by high-shape-factor ceramic filters. AM image rejection is greater than 40 dB, i.f. rejection ratio greater than 40 dB and signal-to-noise ratio 40 dB.

With the electrical specifications listed, here are the features we found subjectively interesting, rounding off the receiver's excellence. First the appearance and feel of the front panel controls are solid. From the tuning flywheel inertia to the tuning and sig-

nal level meter damping everything seems perfect. Swinging to their final positions quickly and decisively the two meters exhibit no observable overshoot. The meters use their full scale travel usefully. Switching to the AM band turns off the tuning meter illumination with the signal strength meter remaining operative. The knobs and switches are beautifully machined and the red dial pointer is strikingly illuminated by a travelling pilot lamp. A convenient feature is a front panel microphone connector and mixing level control. With a microphone plugged in, the receiver can be used as a PA amplifier without struggling with rear panel potentiometers, or by using the mixer control the microphone output can be mixed and faded with the receiver input signals in all operating modes.

Popping during on/off switching is prevented by a transient killer circuit. When switched on, the volume increases gradually until reaching the level determined by the volume control. The time constants of the FM muting circuit are ideal so there is no annoying excessive time lag when tuning across the FM band. Electronic temperature protection senses high temperatures due to internal or external sources. The output power transistors are mounted externally on the rear panel with shock protection shields, eliminating the main source of heat dissipation from the cabinet interior. Any slight internal heat buildup is taken care of by a neat screened vent slot along the rear top of the cabinet for enhanced reliability. Short circuit protection for the power output transistors gives fool proof main amplifier operation. The rear panel includes the normal phono inputs plus two pairs of auxiliary input jacks. Three pairs of tape jacks give versatility in mixing inputs with the supervision of the front panel volume and microphone mixing controls. Two sets of speakers can be hooked up and used in any combination selected by a front-panel switch. A large handling chart details the operating functions of all front panel controls and jacks. The

(continued on page 80)

# We can be instrumental in your success.

Radio Shack's exclusive Micronta® test instruments are proof that reliable measurements and rugged "knock-around" dependability can be yours at low cost. Whether you're setting up a service shop or laboratory, or need instruments in your hobby, pay less and get much more with Micronta. Exclusive at 1600 Radio Shack stores in all 50 states.



100k-Ohm Multitester. None finer at this price! Matched pair of silicon diodes prevents overload damage. Mirrored, no-parallax scale; 4" meter;  $\pm 2\%$  accuracy. Reads DC volts: 0-500 mV, 0-2.5-10-50-250-500-1000 volts at 100,000 ohms/volt. AC volts: 0-2.5-10-50-250-1000 volts at 12,500 ohms/volt. DC current: 0-10-250  $\mu$ A, 0-2.5-25-250 mA. 0-10 A. Resistance, 0-2k-20k-200k-20 meg. Decibels, -20 to +62 in 5 ranges. Batteries, leads, included. 34.95



20k-Ohm



30k-Ohm

20k-Ohm Multitester. Low-priced VOM with "expensive model" features. Reads DC volts: 0-5-25-125-500-1000 at 20k ohms/volt. AC volts: 0-10-50-250-1000 at 10k ohms/volt. DC current: 0-50  $\mu$ A, 0-250 mA. Ohms: 0-6k-60k. Decibels: -20 to +62. Mirrored scale, single-knob selector. With leads, battery 11.95.

30k-Ohm Multitester.  $3\frac{1}{2}$ " meter is easy to read and has single-knob selection. DC volts: 0-0.6-3-15-60-300-600-1200-3000 at 30k ohms/volt. AC volts: 0-6-30-120-600-1200 at 15k ohms/volt. Resistance: X1, X100, X1000, X10k ohms. DC current: 0-0.3-6-60-600 mA. Decibels: -20 to +63 in 5 ranges. Batteries and leads 21.95

50k-Ohm Multitester. Versatile "range doubler" circuit. Accurate for both current and voltage ranges—especially recommended for low-voltage transistor servicing. 4" meter has color-coded, mirrored scale. Ranges: DC volts: 0.125-1.25-5-25-125-500 at 50k ohms/volt; 0.25-2.5-10-50-250-1000 at 25k ohms/volt. AC volts: 1.5-5-25-125-500 at 10k ohms/volt, 3-10-50-250-1000 at 5k ohms/volt. DC current: 50  $\mu$ A-5 mA-50 mA-500 mA-10 A; 25  $\mu$ A-2.5 mA-25 mA-250 mA-5 A. Resistance: 0-16k 160k ohms; 1.6-16 meg. Decibels: -20 to +62 in 10 ranges. 50" test leads, plugs, batteries. Handle doubles as stand. 27.95



Variable DC Power Supply. Output voltages from 0-24 volts at one amp. Dual-function panel meter, volts and current. Input: 120 v. AC at 60 Hz. Output current: 1 amp constant over entire range with 1.5-amp surge. Equipped with circuit breaker. UL listed. 29.95

Dynamic Transistor Checker. Shows electrode open and short circuits, current gain to test low, medium, high-power PNP and NPN types. Permits matching of similar transistors in operating circuits. GO/NO GO test from 5-50 mA on power types. Front panel quick-check socket; clip leads for "in-circuit" test. 12.95



**FREE '73 CATALOG! AT YOUR NEARBY STORE OR SEND IN THIS COUPON**

180 pages! Stereo Hi-Fi, CB, Ham, Kits, Radios, Recorders, Tools, More!

Name \_\_\_\_\_ Apt. # \_\_\_\_\_  
 Street \_\_\_\_\_  
 City \_\_\_\_\_ State \_\_\_\_\_ Zip \_\_\_\_\_

Circle 18 on reader service card

# Radio Shack

and ALLIED RADIO STORES  
 A TANDY CORPORATION COMPANY

P. O. Box 1052, Fort Worth, Texas 76107

# THE MITS 1200 SERIES... "AT HOME-OFFICE-SCHOOL" & "ON THE MOVE" CALCULATORS!

THE 1200 SERIES – 12-DIGIT CAPACITY CALCULATORS  
ADD . . . SUBTRACT . . . MULTIPLY . . . DIVIDE INSTANTLY & ELECTRONICALLY!

At a price most everyone can afford . . . . . Students, housewives and businessmen alike can now have at their fingertips the newest products of solid-state integrated circuit (IC) technology.

FIGURE . . . ■ BUDGETS ■ INCOME TAXES ■ PERCENTAGES ■ MONTHLY STATEMENTS  
■ GROCERY LISTS ■ CREDIT CARD STATEMENTS



## 1230

**DESK CALCULATOR.** Our newest 4-function 12-digit desk calculator with Sperry gas discharge displays includes the features of the 1200 pocket calculator in an attractive desktop cabinet. Use it anywhere – in the home, at school or in the office – wherever 110 VAC is available.

1230 KIT: \$89.95                      ASSEMBLED: \$99.95

## THE 1240 DESK CALCULATOR WITH AN INDEPENDENT MEMORY

In addition to the many 1230 features, the 1240 has a memory register with 4 separate controls . . . it can be added to, subtracted from, recalled to the display or cleared without clearing the calculator. The fixed decimal can be set anywhere from 0 to 5 places. With these features, in Kit form or Assembled, the 1240's price is unbeatable!

1240 KIT: \$119.95                      ASSEMBLED: \$149.95

1230/1240 Padded leatherette or rigid vinyl carrying case . . . \$9.95

## 1200 SERIES POCKET CALCULATORS FOR "ON-THE-MOVE" APPLICATIONS!



SIZE: 5¼" H x 3¼" W x 1½" D  
Hi-impact ABS case

### PRICES

1206	Assembled \$59.95
(6 digits)	Kit \$49.95
1209	Assembled \$79.95
(9 digits)	Kit \$69.95
1212	Assembled \$99.95
(12 digits)	Kit \$89.95

3 MODELS ALL WITH 12-DIGIT CAPACITY!

The 1212 displays 12 digits . . . up to Nine Billion, Nine Hundred Ninety Nine Million, Nine Hundred Ninety Nine Thousand, Nine Hundred Ninety Nine, point Nine Nine. Great where "desk model capacity" is desired.

The 1209 displays 9 digits for more complex at home use or for many office applications.

The 1206 displays 6 digits, sufficient for student and most home uses. These "Pocket miracles" are all 100% American made featuring bright LED display, raised keys, leading zero suppression, fixed decimal output, true credit balance sign display, chain and mixed operation, automatic display cut-off, clear and clear entry keys. Battery life is exceptional, up to sixty hours operating time.

High quality leatherette carrying case . . . . . \$5.95

**AC ADAPTER** Equips any MITS 1200 series pocket calculator for operation from 110 VAC . . . \$6.95

Use Your BankAmericard or Master Charge

WRITE OR MAIL COUPON FOR ADDITIONAL INFORMATION:

**MITS®** Micro Instrumentation & Telemetry Systems, Inc.

5404 Coal Ave., S. E., Albuquerque, New Mexico 87108  
505/265-7553

ENCLOSED IS CHECK  KIT  
FOR MODEL # \_\_\_\_\_  ASSEMBLED

AMOUNT OF CHECK \$ \_\_\_\_\_ R 273  
Include \$5.00 for postage and handling.

Please send information on entire MITS line.

NAME \_\_\_\_\_  
ADDRESS \_\_\_\_\_  
CITY \_\_\_\_\_  
STATE & ZIP \_\_\_\_\_

Circle 19 on reader service card

# SEE HOW IT WORKS

## Digital Clock On A Chip

*Twelve- or 24-hour displays, alarm, snooze-alarm and clock-radio formats are offered in three MOS LSI circuits.*

by LARRY SULLIVAN\*

A NEW FAMILY OF THREE MOS IC'S FOR use in electronic digital clocks makes possible several different types of "single chip" clocks. These devices have been introduced by Mostek Corporation of Carrollton, Texas.

All members of this "clock family" are six-digit clocks that display time in hours, minutes, and seconds. If only an hours and minutes clock is desired the same IC may be used with only the two hours and two minutes digits connected to the display. Outputs from these clocks may be connected directly to fluorescent-anode display tubes. The high-voltage output transistors allow fluorescent-anode display tubes to be driven directly.

The MK 5017 P clock circuits are available now in an alarm clock version, the MK 5017 P AA; a clock radio clock, the MK 5017 P AN; and a unique combination clock/calendar the MK 5017 P BB. Time may be dis-

\*Mostek Corp., 1215 West Crosby Road, Carrollton, Tex.

played in either 12-hour or 24-hour formats.

The standard United States 60-Hz power line frequency may be used as a reference. If the clock is intended for overseas operation where 50 Hz is the standard power line frequency, the 50-Hz input frequency reference may be selected. The MK 5017 P clock senses the power supply voltage and, if loss of power is detected, displays all "eights". A backup battery may be used as a power supply during temporary power loss. An adjustable 50-Hz or 60-Hz oscillator is included on the chip to furnish the frequency reference during temporary loss of power.

The clock circuits require only a single power-supply voltage, simplifying power supply design.

Time setting is easy, a matter of depressing and holding push-buttons which allow the internal counters to increment at a 2-Hz rate. Each of the minutes digits and the hours digits

may be set individually with no "carries" generated to the more significant digits. Thus, there is no "overrun" when setting the counter to a time such as 2:59. In a counter in which "carries" are allowed between digits it is very easy to increment the minutes "9" by one extra count and change all three digits so that the time reads 3:00. This makes it necessary to reset the hours, tens of minutes, and minutes all over again.

### How it works

Figure 1 is a functional block diagram of the MK 5017 P digital clock circuit. A 1-Hz reference frequency is generated for the time counter by the shaper-divider network from either a 50-Hz or a 60-Hz input. The 50/60-Hz input frequency may be derived from the ac line or can be provided by an external crystal-controlled oscillator and frequency divider for portable or automobile applications. When the ac

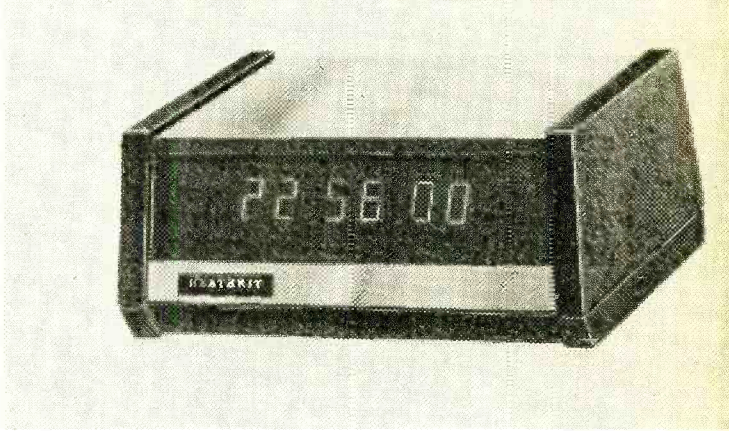
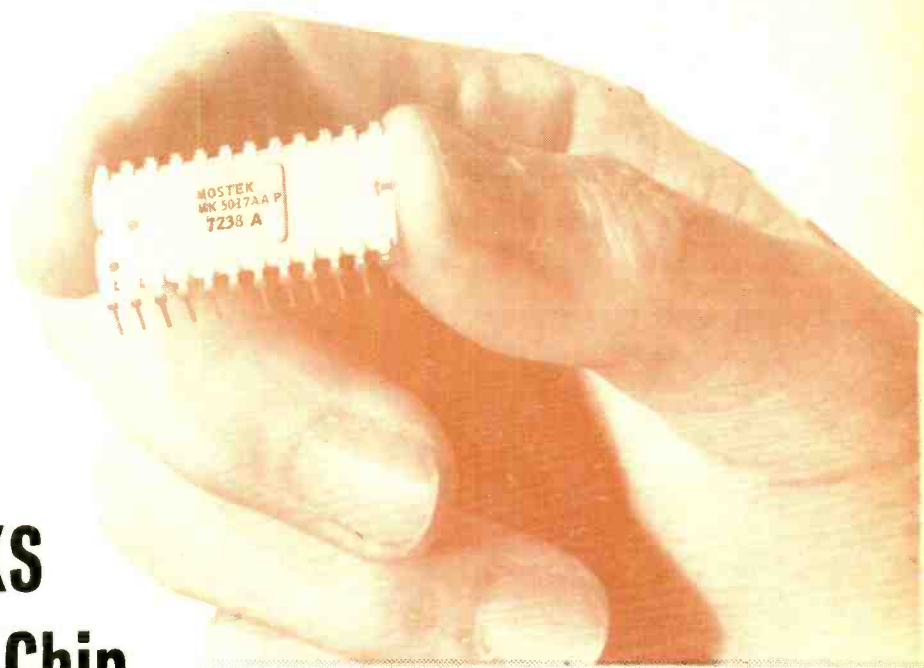

power line is used as a frequency reference, the user is faced with the problem of temporary power loss. An on-chip temporary R-C oscillator may be used to provide the frequency reference through temporary power loss periods if a battery is used to provide chip power through the power transient.

Time is measured by incrementing the time counter at a 1-Hz rate. The contents of the time counter are decoded from BCD to seven-segment form and multiplexed out as serial digits. An external resistor and capacitor may be used to control the frequency of the scan-rate oscillator and thus control the rate at which the display digits are scanned. This allows various display types with different scanning characteristics to be used. Six-digit output strobes identify the digit being multiplexed out of the circuit at a particular time. The digits are scanned sequentially from least significant to most significant. That is, the seconds digit is followed by the tens of seconds digits which is followed by the minutes digit.

An alarm counter may be set externally in the same manner as the time counter. While in the alarm set mode, the contents of the alarm counter are displayed. In the run mode when the alarm comparator detects coincidence between the time counter and the alarm counter the alarm control circuit generates an alarm tone. (The new Heathkit GC-1005 digital clock kit is built around a version of the Mostek IC. The description of the alarm clock that follows is the Heath clock.—*Editor*)

### MK 5017 P AA

The alarm clock version of this chip, the MK 5017 P AA, features a 24-hour alarm. An alarm tone at a frequency of approximately 700 Hz is generated on the chip by an internal oscillator. This alarm tone, suitably buffered, may be coupled into an inexpensive miniature speaker.

An AM/PM indicator is also provided to allow setting the alarm on a 24-hour basis. The AM/PM output, designated AM in Fig. 2, is pulled high to  $V_{SS}$  by the transistor to indicate AM. The AM output appears as an open circuit for PM.

If seconds are not being displayed the user may wish to use the optional 1-Hz output, available upon request, to blink the AM/PM indicator. This provides a visual indication that the clock is running. Figure 2 shows a typical circuit for a digital alarm clock using the MK 5017 P AA or MK 5017 P AN and seven-segment fluorescent-anode display tubes. The power supply consisting of transformer T1, rectifier diode D4, and filter capacitor C3

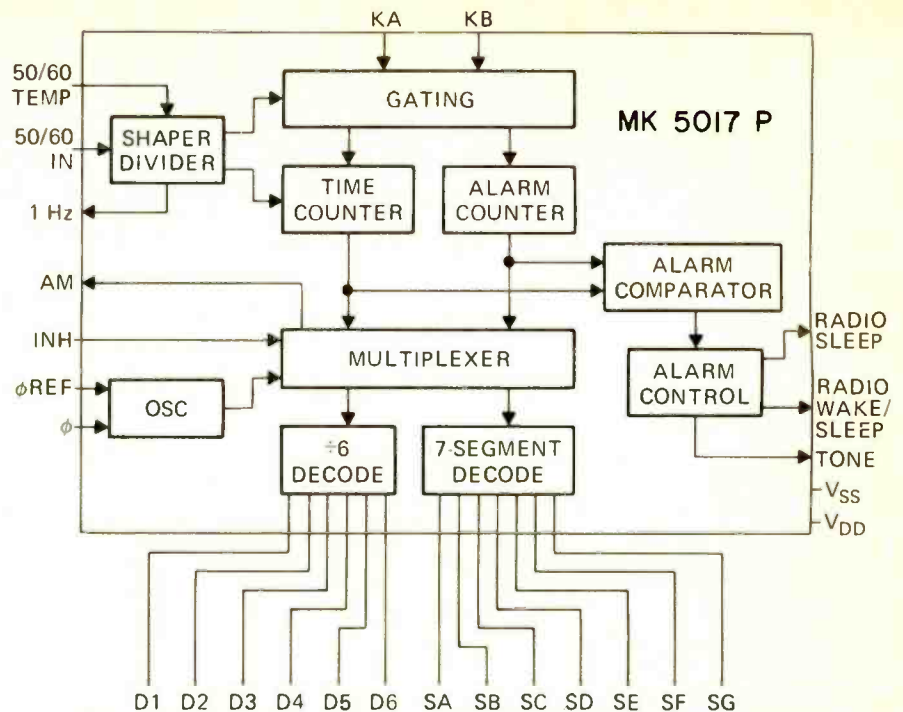

FIG. 1—BLOCK DIAGRAM of the IC for a digital electronic clock. The frequency standard can be a 50- or 60-Hz line, external crystal oscillator or the internal R-C source during power outages.

generates approximately (-35Vdc). Reference diode D3 reduces the power supply output voltage to (-15V) for the IC's  $V_{DD}$  supply voltage. The optional backup batteries shown may be used to prevent loss of time during temporary power transients. Diode D2 remains OFF isolating the batteries from the power supply in normal operation. If ac power is removed, D2 is biased on by the batteries and provides the integrated circuit with  $V_{DD}$  supply voltage to prevent loss of time. While the ac power is OFF the voltage on the 50/60 IN pin remains at a steady logical one. The chip detects this condition and continues to measure time using its own 50/60 Hz internal oscillators as a time base.

The frequency of this oscillator may be set at either 50 Hz or 60 Hz by adjusting R1.

When ac power is present, the 60-Hz sinusoidal waveform from transformer T1 is half-wave rectified by diode D1 and reduced from a (-35) volt peak to a voltage one or two volts more negative than  $V_{DD}$  by the resistive divider composed of R2 and R3. Capacitor C2 serves as a noise-spike suppressor and prevents false counts from noise spikes induced on the ac line by equipment using SCR switching or universal motors.

Fluorescent-anode display tubes are shown in this example. As shown, fluorescent-anode tubes may be driven directly by the clock circuit. The display tube anodes are connected directly to the clock segment outputs. The cathodes are driven by the individual digit outputs.

These display tubes have a common cathode and heaters. The 6.3 Vac winding of transformer T1 is reduced to approximately 4.2 Vac by resistor R4 since the individual filament voltage is about 0.7 volt. This series filament "string" is biased at about (-25Vac) by transistor Q1.

Display brightness can be varied by adjusting variable resistor R5 which sets the base voltage of transistor Q1. Q1 acts as an emitter follower keeping a constant cathode bias on the display tubes.

There are two function input pins, KA and KB. Both KA and KB pins are sampled during each digit strobe. The intersection of the six-digit output strobe lines and the KA and KB lines forms a matrix that is  $6 \times 2$ . That is, there are 12 potential locations where a spst switch may be located. These switches may be used to define 12 separate functions or modes of operation for the circuit. For example, at D6 time the KA line is sampled to determine if the time set switch is closed. If the time set switch is closed, the KA line will be pulled high to  $V_{SS}$  by the D6 output driver transistor. Isolation diodes D5 through D16 prevent the digit outputs from being tied together in case of multiple switch closures. For example, if the time set switch at the intersection of D6 and KA and the hours switch at the intersection of D5 and KA were both closed, the D5 and D6 digit strobe outputs would be tied together if diodes D6 and D7 were omitted. At D5 time D6 is reverse-biased so the D6 line is not pulled high by the D5 output. Similarly, at



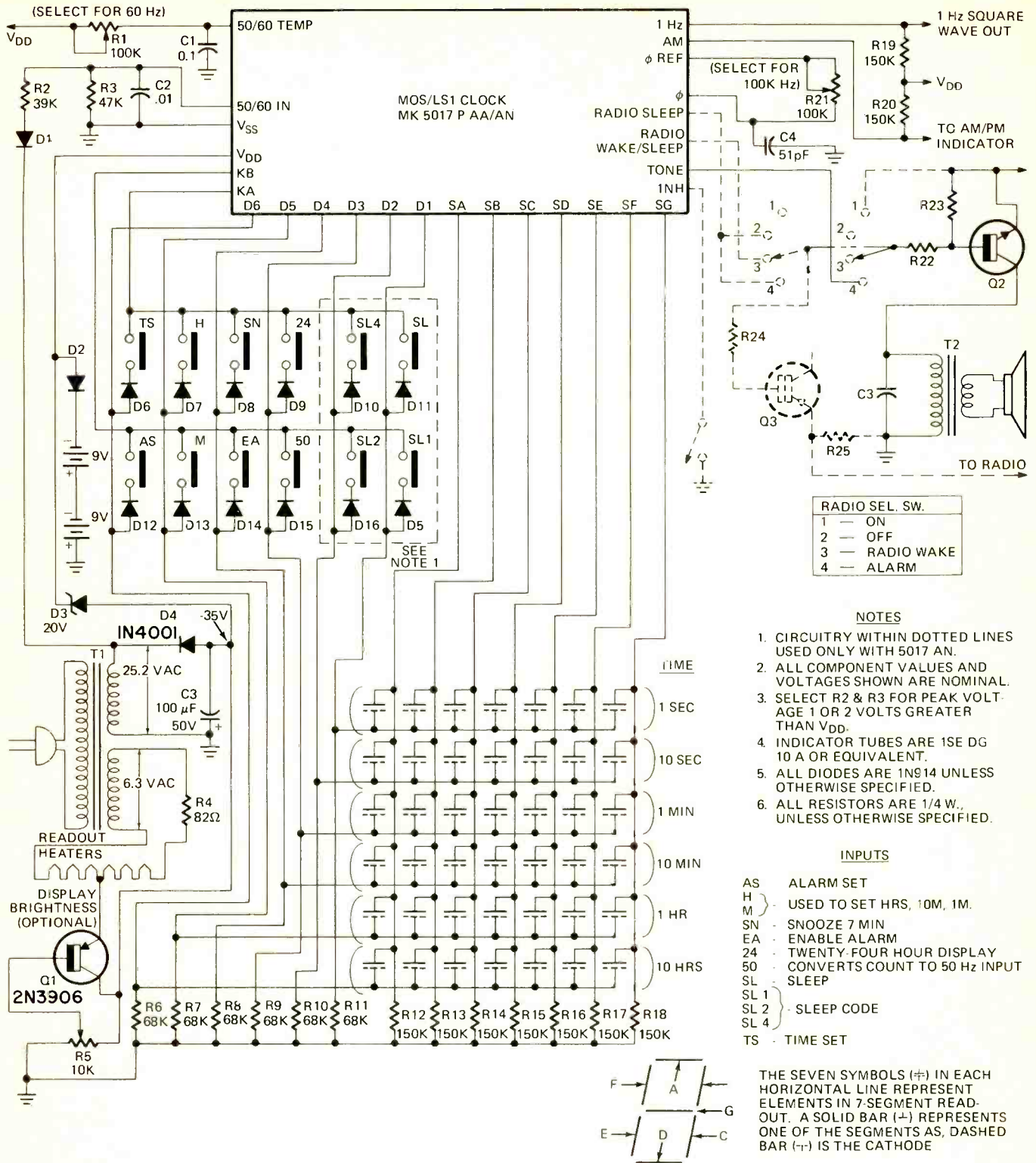

FIG. 2—COMPLETE DIAGRAM OF A DIGITAL ELECTRONIC CLOCK. Fluorescent-anode display tubes can be driven directly by the IC.

D6 time D7 is reverse-biased so the D5 line is not pulled high by the D6 output transistor. Since the KA and KB inputs are time multiplexed, it is possible to connect 12 switches to only two input pins keeping the circuit in a 24-pin package.

As shown in the INPUTS table on Fig. 2, the switch located at the intersection of the D6 and KA line defines the TIME SET mode. The switch is

closed in the TIME SET mode. In this mode of operation the contents of the time counter are displayed. Counting is stopped in the TIME SET mode and the seconds and "tens-of-seconds" digits are both held at zero. When the time set switch is released, the clock begins running.

The switch located at the intersection of D6 and KB is used to define the ALARM SET mode. In the ALARM

SET mode of operation the contents of the alarm counter are displayed. The time counter continues running while the alarm is being set.

Closing the switch located at the intersection of the D5 and KA lines causes the hours digit to advance at the rate of two digits per second, (a 2-Hz rate). Closing the switch located at the D5 and KB intersection causes the minutes digit to advance at a 2-Hz

rate. If both the hours and the minutes switches are closed simultaneously the "tens-of-minutes" digit advances twice each second.

Enabling the alarm is accomplished by closing the switch located at the intersection of the *D4* and *KB* lines. When coincidence is detected between the time counter and the alarm counter, the alarm tone is gen-

*D2* and *KB* lines (*SL2*), and at the intersection of the *D2* and *KA* lines (*SL2*), are used to select the desired sleep time. There are eight possible combinations that may be achieved with these three switches, so a total of eight different sleep times may be selected. The switches are arranged in a binary code with the switch designated as *SL1* being the least significant bit.

**SLEEP SWITCH TABLE**

Radio Sleep Time	Switch Combinations		
	<i>SL4</i>	<i>SL2</i>	<i>SL1</i>
10 Min	open	open	open
20 Min	open	open	closed
30 Min	open	closed	open
40 Min	open	closed	closed
50 Min	closed	open	open
60 Min	closed	open	closed
90 Min	closed	closed	open
120 Min	closed	closed	closed

erated for one hour if the enable alarm switch is closed.

When the alarm "goes off" the snooze switch located at the intersection of the *D4* and *KA* lines may be momentarily depressed to inhibit the alarm. After seven minutes the alarm will go off again. This cycle may be repeated indefinitely.

Twelve or twenty-four hour time displays may be selected at any time without disturbing the time counter. Closing the switch located at the intersection of the *D3* and *KA* line results in a twenty-four hour display.

For operation from a 50-Hz reference frequency, the switch located at the intersection of the *D3* and *KB* lines may be closed. When this switch is open, the clock assumes a 60-Hz reference frequency.

### MK 5017 P AN

Clock radio clocks may be built using the MK 5017 P AN. This circuit includes all of the features normally found on a clock radio clock. Both the alarm clock - MK 5017 P AA, and the clock-radio clock - MK 5917 P AN are shown in Fig. 2. The circuitry shown by dashed lines applies to the clock-radio clock. The remaining circuitry is common to both.

In addition to all of the features found on the alarm clock circuit the clock-radio circuit also has a radio sleep output that may be used to keep a radio or other appliance on for selected periods of time up to a maximum of two hours.

Radio sleep operation is selected by closing switch *SL* at the intersection of the *D1* and *KA* lines in the input matrix. The switches located at the intersection of the *D1* and *KB* lines (*SL1*) at the intersection of the

The switch designated as *SL4* is the most significant bit. The times that may be selected, along with the switch closures required to program these times, are presented in table.

After selecting the desired radio sleep time from the table, close the sleep switch to start the timing interval. It is not necessary to install three switches and remember the binary code for sleep times. Instead, an eight-position three-pole rotary switch may be used to easily and rapidly select sleep times.

In addition to the radio sleep feature the MK 5017 AA also has a radio WAKE/SLEEP output. The radio WAKE/SLEEP output is operative during RADIO WAKE and RADIO SLEEP operation. For RADIO WAKE operation the radio WAKE/SLEEP output is on when the alarm counter and the time counter become equal. The radio WAKE/SLEEP output remains active for one hour during *radio wake* operation.

A display inhibit pin is included on the clock-radio clock circuit. All of the segment- and digit-output transistors are disabled (turned off) when the inhibit pin is connected to  $V_{SS}$ . This feature makes it possible to build a multifunction clock using only one display, without any external multiplexing circuits. **R-E**

### COLOR TV RECORD GROWTH

As of October 1, 1972, the total number of households in the U.S. that have color TV increased to 37,300,000, according to the latest quarterly estimate by the National Broadcasting Company. This represents an increase of 3.8 million in color-TV households since January 1, 1972.

# service notes

### G-E C2/L2 COLOR CHASSIS TINT CONTROL INEFFECTIVE

Color rendition may or may not be close to normal. Check or replace the 3.58-MHz crystal. A universal replacement may not work. Original parts numbers are EP41X1 and EU41X3 for 3-lead and 2-lead crystals, respectively.—*G-E Service Hints*

### TV REPAIR SAFETY CHECKS

Here are several safety precautions that should be observed when servicing television receivers:

1. Always use the original manufacturers' replacement component or a replacement that is of equal quality.

2. When service is required, observe the original lead-dress. Use extra care to assure correct lead dress in the area of high-voltage circuitry.

3. Where a short circuit has occurred, replace those components that show evidence of overheating.

4. When replacing the back cover of the set, check the position of the ac interlock to confirm a proper connection. **CAUTION.** Before returning any equipment to a customer, make sure that no shock hazard exists by performing the following checks:

a) Plug the ac line cord directly into a 120-volt outlet (do not use an isolation transformer for this check).

b) Using two clip leads of sufficient length, place a 1500-ohm, 10-watt resistor in series with an exposed metal cabinet part and a good earth ground such as a water pipe.

c) Use an ac voltmeter with a sensitivity of 1000-ohms-per-volt or more to measure the voltage across the resistor. **A reading of 3.0 volts or more indicates a shock hazard that must be corrected.**

d) Move the resistor connection to each exposed metal part (antennas, handle bracket, metal cabinet, screw heads, control shafts, metallized plastic overlays, etc.) and measure the potential across the resistor at each new connection.

e) Reverse the plug in the ac outlet and repeat the measurements in steps c and d.

**Correct any shock hazards before returning the instrument to the customer.**—*RCA Television Service Bulletin*

### NEXT MONTH

March is a special stereo issue. You won't want to miss any of the exciting articles. It goes on sale February 20th.

# INFRARED

## *and its many applications*

ONE OF THE MOST EXCITING PARTS OF THE ELECTROMAGNETIC spectrum is the portion between visible light and radio waves, the *invisible infrared*. Sir William Hershell discovered the existence of invisible "light" just beyond the visible spectrum in 1800 when he noticed that a thermometer placed just adjacent to the red part of a spectrum produced by a prism indicated a temperature rise. Since the newly discovered radiation was just beyond the red, Hershell called it infra-(meaning *below*) red.

Since 1800, hundreds of applications have been found for infrared. But technological achievements in lasers and infrared detectors have greatly increased the variety of applications in recent years. For example, sensitive infrared detectors are being used in non-destructive testing of many forms of electronic components and circuits—including complex integrated circuits. The military is using infrared in a great variety of applications ranging from invisible beam communication systems to thermal mapping cameras that photograph enemy territory under cover of total darkness. A military application that has made news in recent months is the so-called "smart bomb." Guided to its target by the invisible infrared beam from a powerful laser, these new guided bombs give Air Force pilots uncanny accuracy in combat situations.

There are many other applications for infrared which are entirely new, and we'll discuss some of them shortly. But first let's see how infrared is generated and how it can be detected.

### **Infrared sources**

Amazing as it seems, all matter with a temperature greater than absolute zero (a chilly  $-273^{\circ}$  C) emits some degree of infrared radiation. This radiation may have a wavelength ranging from the near IR at about 0.8 microns to the far IR in excess of 30 microns. The wavelength is related to temperature, and cold objects emit at much longer wavelengths than warm objects. For example, human skin at its temperature of about  $98.6^{\circ}$  F emits IR radiation at a range of wavelengths centered around 9.3 microns. Objects with a higher temperature emit at shorter wavelengths which may even include the visible part of the electromagnetic spectrum—hence the expressions *red hot* and *white hot*.

Half the radiation from the sun is in the IR and more than 80% of the light from an incandescent lamp falls outside the visible spectrum and in the infrared. Many lasers,

*Before infrared can be used for many applications, we must either detect or measure it. Here is how these are accomplished*

by FORREST MIMS

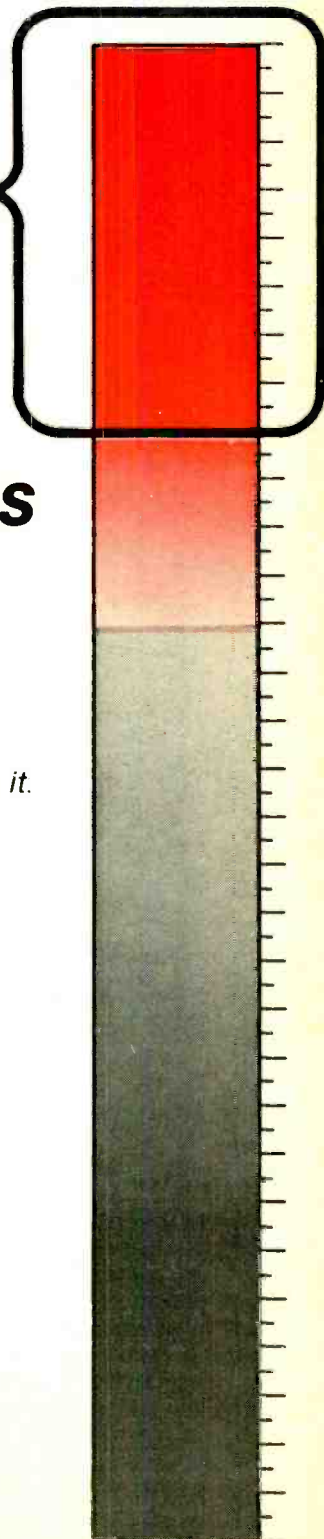

including most of the semiconductor versions, emit very narrow wavelength lines of infrared. For example, the gallium arsenide laser system described in the June 1972 issue of **Radio-Electronics** emits at a peak wavelength of about 0.91 microns, while certain lead-salt semiconductor lasers emit at wavelengths extending out to 30 microns.

Other sources of IR include flames, arcs, and what is called a *blackbody*. The blackbody emitter is used to calibrate IR detectors and operates on the principle that a perfect absorber of IR is also a perfect emitter. A typical blackbody may have the appearance of a cone (Fig. 1). IR

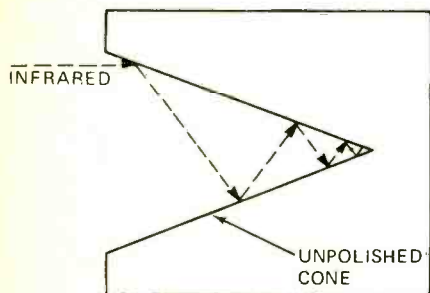

INCOMING RAY OF IR IS ALMOST COMPLETELY ABSORBED BY THE WALLS OF THE CONE AS IT BOUNCES BACK AND FORTH.

FIG. 1—BLACK-BODY as an IR detector may be a block with cone-shaped aperture a near-perfect IR absorber.

entering the cone is reflected from wall to wall with a large amount being absorbed by the wall of the cone. By the time the radiation reaches the apex of the cone, most of it has been absorbed.

The blackbody emitter can also be used as an IR detector. Such a device is called a calorimeter and it is frequently used to measure laser energy. In operation, the outside surface of the cone is connected to an array of tiny thermocouples that measure the temperature increase of the cone as IR is projected into it. By comparing the temperature rise with a calibration curve, energy can be measured accurately.

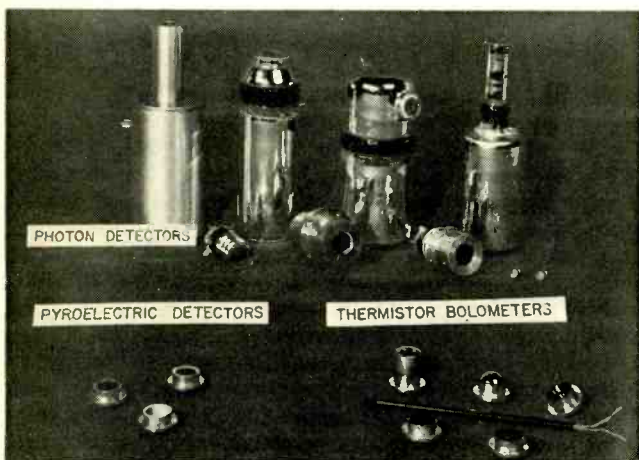

TYPICAL IR DETECTOR TYPES. Most of the photon detectors shown are in Dewar vacuum bottles for low-temperature operation.

Most practical calorimeters use two cones. Each one is connected to a separate thermocouple array. One cone receives the IR being measured, and the other serves as a reference to counteract the effects of ambient temperature changes.

### Detectors of infrared

The cone calorimeter is actually one of two classes of IR detectors. The two classes are *thermal* and *quantum* detectors, and the calorimeter falls in the thermal class. Thermal detectors depend on the temperature increase that ac-

companies the IR projected onto a detector surface. Quantum detectors exploit electron-hole movement within a semiconductor.

The simplest thermal detector is the one used by Hershell in 1800, the common thermometer. IR striking the thermometer heats the liquid within. The liquid, typically colored alcohol or mercury, expands and rises through a glass capillary marked with a calibrated scale. More recently, a "solid state" thermometer using a coiled bimetal strip is commonly used. In operation, heat causes one side of the bimetal strip to expand more than the other, making the coil wind or unwind. A pointer connected to the center of the coil indicates the temperature.

Other thermal detectors also use mechanical techniques. The Golay Cell, for example, consists of a xenon-filled chamber that expands when IR is directed into it. The expansion of the cell, hence the amount of IR, is indicated by a tiny mirror connected to a bellows. A beam of light directed against the mirror and reflected onto a calibrated scale indicates the quantity of IR. This kind of detector is called a *thermopneumatic* cell.

Electronics has greatly improved the simplicity and reliability of thermal detectors. The thermocouple has already been described. Consisting of a junction of two dissimilar wires, thermocouples are among the simplest of IR detectors.

A more sensitive detector is the *bolometer*, a soot blackened piece of platinum foil. A wire attached to either

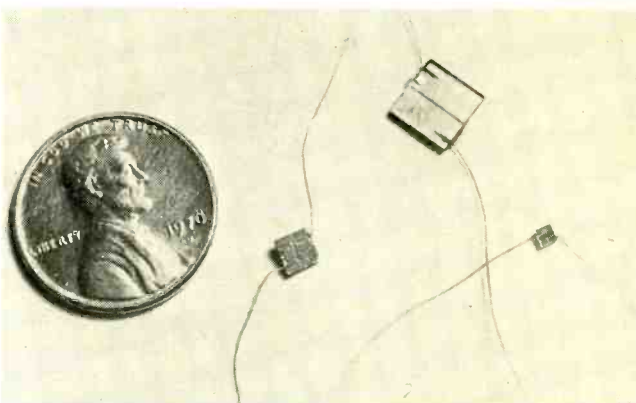

LEAD SULFIDE DETECTORS have PbS wafers between thin quartz layers for protection and transmission of IR it is designed to sense.

end of the foil is connected to a meter that measures the resistance change in the foil as it is heated by infrared. Because of the soot, the foil absorbs nearly all the infrared striking it, thus making measurements easier to perform when very small quantities of energy are involved.

A more sophisticated electronic thermal detector is the *thermistor*. Consisting of a tiny semiconductor chip, the thermistor is essentially a heat-controlled resistor. Its small size gives it fairly rapid response time. Thermistors are inexpensive and are frequently used for temperature stabilization of electronic circuits.

Recently, a new type of electronic thermal detector has become popular in IR sensing applications. Called the *pyroelectric detector*, its operation depends upon the absorption of heat by a thin wafer of a ferroelectric crystal such as triglycine sulfate (TGS). The crystal is fabricated in such a manner that it resembles a capacitor. Heat alters the value of the capacitor, and the resulting change can be monitored by suitable circuitry. Since the detector has a high output impedance, sometimes they are made with a self-contained FET stage to reduce impedance to a more acceptable level.

The thermal detectors we have been discussing are too slow or not sensitive enough for many applications. The development of improved quantum detectors has helped al-

leviate this problem. Thermal detectors tend to have slow rise and fall times since the detector itself must become heated by the IR. Since the heating requires a finite time, the detector has a relatively slow response time. Quantum detectors do not depend on heating of the detector for proper operation. They use the movement of holes and electrons in a semiconductor material exposed to infrared.

There are three major classes of quantum detectors: photoconductive, photovoltaic, and photoelectromagnetic (PEM). The first two operate just like their visible light counterparts, photoresistors and photodiodes.

One of the most common infrared sensitive photoresistors is the lead sulfide cell. Closely related to the cadmium



**QUANTUM INFRARED DETECTOR.** The window visible in the bottom of the Dewar assembly is transparent to infrared wavelengths.

sulfide cell used to detect visible light, the lead sulfide (PbS) device employs bulk material without a pn junction. A typical cell consists of a quartz substrate containing two evaporated electrodes separated by a thin space. A strip of PbS is deposited across the space separating the electrodes in the form of a semiconducting bridge, and tiny wires are connected to the electrodes. The cell is completed by bonding a thin quartz cover onto the substrate to form a protective window. Quartz is frequently used because of its infrared transmission properties.

There is a great variety of other photoconductive infrared detectors. While PbS is used for wavelengths peaking near 2.5-3.0 microns, indium antimonide (InSb) is used for the 6-7 micron range. Doped germanium detectors are used for much higher wavelengths. For example, mercury-doped germanium (Ge:Hg) is used for 10 microns and zinc-doped germanium (Ge:Zn) for 20 to 38 microns. Ge:Hg is frequently used in military systems designed to detect human beings since its peak sensitivity nearly matches the peak IR emission of the target.

Photovoltaic IR detectors include silicon (Si), germanium (Ge), indium antimonide (InSb), and mercury cadmium telluride (HgCdTe). While photoconductive cells alter their internal resistance when illuminated by infrared, photovoltaic detectors generate a voltage. Silicon and germanium detectors have a peak response in the near IR at around 0.85 to 1.4 microns respectively. They are particularly useful for detecting near IR beams from lasers and light-emitting diodes. They have very fast response times and good sensitivity. The other detectors listed above are sensitive to longer wavelength IR and are used in a variety of detection applications.

PEM detectors operate on the principle that a magnetic field will separate charge carriers in certain semiconductors. Indium antimonide, the material used for both photoconductive and photovoltaic detectors, and mercury telluride (5% ZnTe, 5% CdTe) are both used in PEM detectors.

### Infrared optics

The question of infrared transmitting materials is an important one. Detectors must be protected by windows, and the windows must be rigid and transparent to the IR being detected. Furthermore, since many IR detectors are operated at very low temperatures for improved performance, the window material must be able to withstand thermal stress.

In visible light applications there are a great variety of materials that are transparent. But materials that are transparent to the human eye and visible light may be completely opaque at IR wavelengths. Conversely, objects that are opaque at visible wavelengths may be transparent to infrared. For example, standard window glass transmits little or no IR beyond about 4 microns, while germanium, which is completely opaque at visible wavelengths, transmits about 50% of the IR between 2 and 15 microns. Other materials that transmit IR include such exotic substances as potassium bromide, cesium iodide, cadmium sulfide, and sodium fluoride. Even common table salt, sodium chloride, is transparent to IR out to 20 microns.

Typical applications for infrared optics include missile seeker heads, Dewar windows, and laser systems. Optics for lasers that emit in the IR beyond several microns pose a difficult problem for research scientists. For the carbon dioxide gas laser, for example, emission is at 10.6 microns. Sodium chloride is one of the few materials that makes a suitable window at this wavelength but it has a tendency to absorb moisture and become clouded. Therefore, salt windows on some IR lasers are removed when not in use and stored in humidity free containers.

### Putting infrared to Work

Since the infrared emitted by an object can be directly

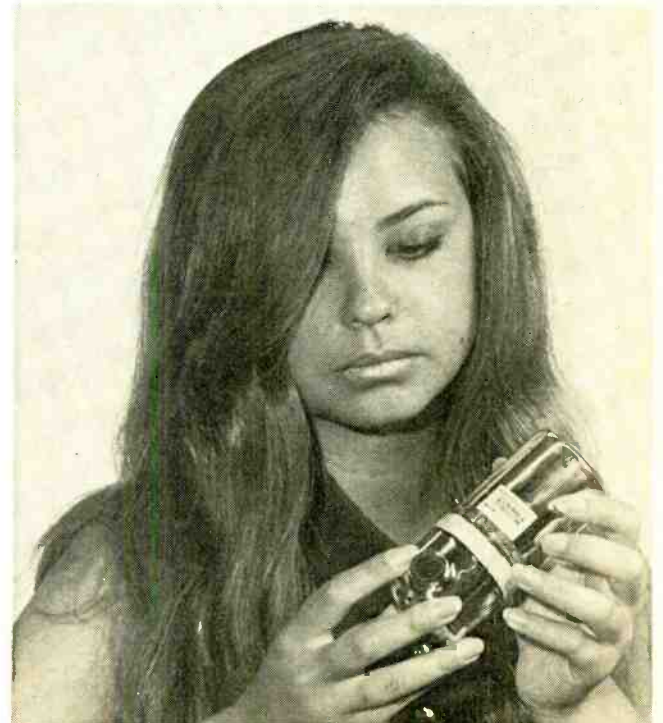

Photos courtesy Barnes Engineering

**THE PHOTON DETECTOR,** shown in closeup photo at upper left, is in a Dewar vacuum jar for operation at temperature of liquid nitrogen.

related to the object's temperature, devices that can sense infrared have many practical applications. For example, simple IR detectors are used to monitor equipment that becomes overheated and triggers an alarm when the temperature exceeds a certain level. The same technique is used in IR fire alarms.

In more sophisticated systems, IR detectors are used to detect animals and people. In one setup two slits in front of a detector cause the device to give an output signal only when the source of infrared has moved. In this way the detector ignores temperature changes and only gives an output when a valid signal is received.

Systems that use IR to form visual images have many valuable applications. The simplest technique for rendering a visible IR image is to use infrared-sensitive photographic film. The Eastman Kodak Company makes several kinds of black-and-white and color IR sensitive film. The films are sensitive to visible light and infrared out to about 0.9 microns and produce striking effects when used to photograph scenery and landscapes. The film is also useful for photographing the beam from near-IR lasers, detecting forgeries, inspecting art objects, and conducting aerial geological and agricultural surveys. Medical applications include locating certain skin diseases, photography of the retina, and studying human behavior without the knowledge of the subject.

For applications beyond 0.9 microns, image-converter tubes are frequently used. These tubes contain an IR sensitive photocathode coated on thin glass window at the front of the tube and given a high potential with respect to one or more electrodes at the rear of the tube. In operation, visible or near IR striking the photocathode triggers the emission of electrons which travel toward a phosphor coated viewing screen. The phosphor screen then glows in a pattern identical to that of the IR projected upon the photocathode.

Image converters are sometimes used with IR sources

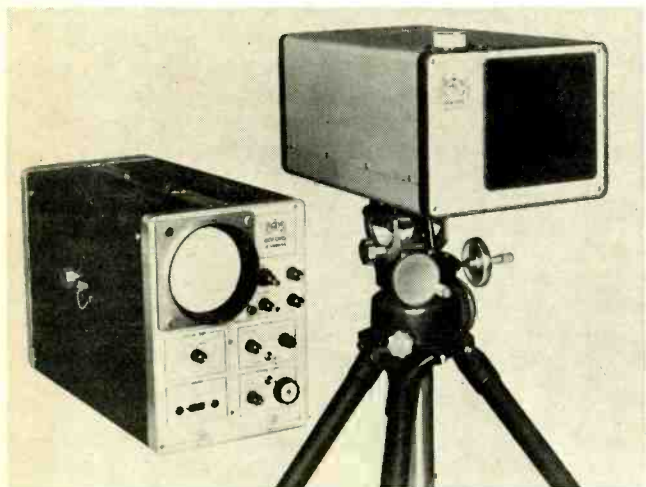

**INFRARED CAMERA**, manufactured in Sweden by A. B. Bofors, has numerous applications in medicine, science and industry.

#### OLYMPIC TD20 TAPE DECK

A problem of drive belts slipping off the motor pulley may be due to a coating of oil on the pulley and the inner surface of the drive belt. This is caused by oil spraying from the upper motor bearing as operating temperature rises. Therefore, a tape deck may not show signs of this condition until after the first hour of operation.

Handle complaints of displaced belts by: 1. Completely remove the belt from the mechanism.

2. Operate the motor continuously (without belt) for four hours.

3. Wipe motor pulley and capstan pulley clean of oil.

4. Invert belt and reinstall so the dry side becomes the inner running surface.

to permit vision in total darkness. Semiconductor lasers, light emitting diodes, or filtered incandescent or xenon lamps provide the IR. The military and police find night viewing systems particularly important, but biologists and astronomers also use image-conversion devices.

Image-converter tubes are impractical at wavelengths beyond about 1.1 microns. For longer wavelengths, IR quantum detectors are employed in a mechanical scanning system. A system of mirrors scans the desired field of view and the output of the detector is fed into a CRT. The result is an image of the IR emitted by an object even though the object may be in total darkness. By using detectors sensitive to 10 microns, we get particularly startling results. For example, the system can "see" a human body and convert it into an image on a CRT screen even though the subject is in darkness.

Infrared scanning cameras are finding a host of applications in research and practical engineering. The cameras are expensive, but the applications frequently justify the price. Military uses are obvious, and each of the services is investigating thermal cameras for camouflage and personnel detection. The Army's Night Vision Laboratory at Fort Belvoir, Virginia, is particularly interested and active in this area of work.

Industrial applications include detection of hot equipment from a distance, non-destructive testing, analysis of welds, and studies of a variety of manufacturing and fabrication techniques. Medical applications include the detection of some kinds of cancer, circulation impairments, and vascular diseases. In earth science studies, IR scanning cameras are used to detect pollution in bodies of water, study the effect of irrigation systems, find diseased crops, and even prospect for mineral formations.

A modification of the scanning camera transfers the image to photographic film instead of a CRT. These systems preserve a record in hard copy of the scene detected and are commonly used in aircraft. Both the military and the Forest Service employ many of these systems, the former for reconnaissance under cover of darkness and the latter for finding forest fires.

#### What's ahead

The past few years have produced a genuine revolution in infrared generation and detection techniques, and if present developments are any indication, we can expect to see even more startling developments in the next few years. For example, the newly developed charge-coupled self-scanned silicon arrays, another Bell Telephone Laboratory invention (see *New & Timely*, **Radio-Electronics**, November, 1972, page 6; and June 1971 page 6.) will permit the fabrication of solid state television systems. The silicon used in present arrays responds to the near infrared, and if InSb and similar materials can be adapted to the technology, far infrared self scanned arrays may only be several years away. Other developments equally as impressive can also be expected, making infrared a field to be closely watched.

R-E

5. Replace the chassis and secure. No further recurrence of this problem should be anticipated.—*Olympic Service Bulletin*

#### SQUEAL—INSUFFICIENT WIDTH

Squeal from the high-voltage cage along with possible reduced width may be caused by chips from the high-voltage transformer core. These chips will vibrate in their lodging place—usually in the air-gap between the halves. If the core is cracked (usually at the right-angle corners) chips will lodge in the crack. Removing the chips will reduce the squeal, but if the core is cracked, it should be replaced. If the portions of the cracked core are separated, insufficient width may occur.—*General Electric Service Hints*

LIKE THE PROVERBIAL MODEL T FORD the old single-trace, recurrent-type (free-running) service scope may soon become obsolete on the service bench.

With the many sophisticated solid-state electronic devices now on the market that require circuit diagnosis, the dual-trace triggered scope is well worth its cost. You can now choose from several models of these glowing one-eyed dual-sweepers. Some technicians tell us they cannot afford to be without one. Many models are now all solid-state, easy to operate and can cut your troubleshooting time considerably. The dual-trace scope is

harmonic content of the sharp rise wavefronts, without any overshoot. The faster the scope's rise-time the better. And of course, most all triggered scopes offer the choice ac or dc vertical amplifier modes at the flip of a switch. Both vertical amplifiers must be balanced and have identical frequency response and amplification.

The primary advantage of a triggered scope compared to a service scope is that its sweep can be started precisely at the same point on each trace. This lets you make very accurate comparisons between two signals or two pulses of the same frequency.

cause of the many different pulses found in the TV video signal.

**Triggered and automatic sweep modes**

To make sure that every one understands what a triggered scope actually is let's take a brief look at its operation. The sweep circuits of a triggered scope are inoperative and the crt blanked (no trace visible) until the proper trigger "on" pulse is applied to the sweep circuit. When the correct pulse is received, a one-shot type of circuit goes into action, unblanks the crt, produces one sweep across the

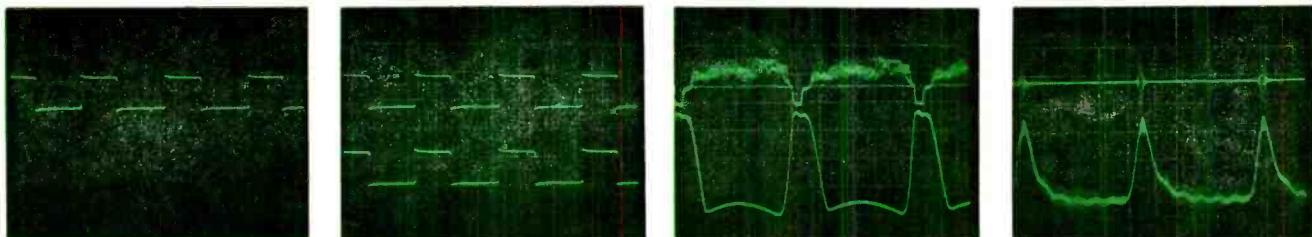

**DUAL-TRACE TRIGGERED-SWEEP SCOPES**



*Once a lab instrument, the triggered-sweep dual-trace scope is now a must on many service benches.*

by **ROBERT L. GOODMAN**

just like having two scopes in one unit, but at a very small additional cost.

**Dual-trace scope features**

The triggered-sweep oscilloscope, be it single or dual-trace, should have these features. The horizontal sweep speed should go to 500 kHz or higher (also referred to as the time-base generator frequency range). This means you have fewer waveforms to look at on the crt when checking high-frequency signals like the 3.58-MHz color CW oscillator.

The frequency response of the vertical amplifiers should be flat to at least 10 MHz. This is needed to see the color burst at 3.58 MHz and the

This is needed to check for correct timing of the color burst, color killer and gated agc circuit operation.

The scope's sweep is actually turned on or "triggered" by the signal pulses that are fed into the vertical amplifier. These pulses are "picked-off" at the vertical amplifier of the scope and fed into the trigger sweep circuits. This is the reason for the rock-solid scope traces. For TV troubleshooting the scope should have the special horizontal and vertical (TVV and TVH) sweep or time-base ranges. To have solid lock on the vertical and horizontal TV sync pulses the scope should have a special TV-type sync separator or filter circuit. Without this filter the scope may not lock-on be-

screen and resets to the "off" state. Sweep does not recur until another pulse of correct amplitude and polarity is applied to the sweep circuit. Most of these scopes also have a free-running sweep mode. A sample pulse is picked off the input signal that is fed into the vertical preamplifier stage to provide the sweep trigger pulse. This is why the triggered instrument produces a stable pattern and solid-as-a-rock lock and is easier to use than the old-time recurrent-sweep service scope.

The automatic triggered feature is no doubt the most useful mode. This mode of operation presets the trigger (sync) level so that adjustment of the sync level control is not needed. The

automatic triggering provides a trace across the crt at all times, with or without an input signal present. The sweep runs at a slow irregular rate until a trigger pulse is sensed. When a signal is applied, the automatic trigger circuit goes into action and gives you a sharp, clean trace with triggered stability. All that has to be set is the input sensitivity and the correct sweep speed needed for signal display. Thus, fast waveform checks can be made without having to jazz around with all of the scope controls.

### Alternate and chopped dual traces

Most dual-trace triggered scopes offer dual-alternate and dual-chopped sweep modes. The dual-trace alternate sweep is the most useful for TV troubleshooting. The trace actually displays each scope channel alternately. The channel A trace is displayed on one sweep while the next sweep cycle displays the channel B input. Then the process starts over again with channel A. Both traces are controlled independently except for the triggering. It is controlled by whatever trigger source is selected. One signal is then displayed with reference to the other channel. When channel A is selected as the trigger source, the channel B signal is displayed in "real time" as compared to channel A. This results because the sweep, regardless of input signals being displayed, is controlled by the signal present at the channel A input. This is very useful when you wish to compare the phase between two signals. Not only are both signals seen, but with a dual-trace triggered-sweep scope, you can see them displayed on a "real time" basis for accurate comparison of timing or phase relationship. This, of course, is not possible with a single-trace triggered scope.

The chopped mode is primarily used for dual-trace display of low-frequency signals below 60 Hz. With such a slow sweep in the dual alternate mode, the trace blinks because the crt's phosphor persistence is not long enough to last until the next trace arrives. As an example, in Fig. 1, the scope is set for dual alternate sweep to look at two 20-Hz square-wave signals. Note that the bottom trace cannot be seen. However, with the scope set in the dual-sweep chopped mode both square wave signals are seen in Fig. 2. The dual-chopped mode provides a steady display by switching between channels A and B at a 100-kHz rate. This means channel A signal is displayed on the positive swing of the 100-kHz chopping square-wave, and the channel B signal is displayed on the negative swing. This reduces the amount of

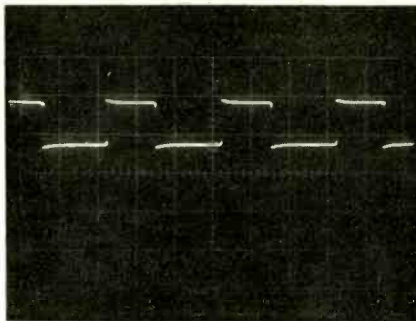

FIG. 1—IN A DUAL ALTERNATE DISPLAY only one trace may be visible.

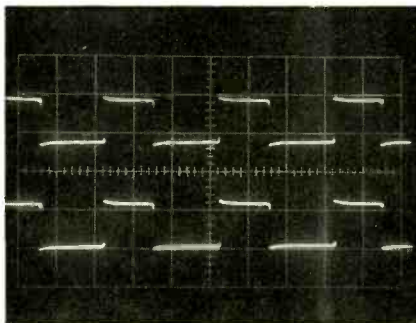

FIG. 2—CHOPPED MODE is best for dual display of signals below 60 Hz.

time between traces and helps to eliminate the flicker. The chopping frequency is high enough to provide an unbroken display of both signals even though they are displayed in segments. The chopped mode can be used to look at TV vertical sweep signals.

### Color TV troubleshooting tips

The color TV receiver has some waveforms that must occur simultaneously. Some examples are the burst amplifiers, color killer and keyed or gated agc circuits. With a dual-trace scope two pulses can be monitored on the screen to see if they are arriving at the same time. This permits you to determine width and timing relation to each other and note how this would affect circuit operation.

Many concurrent waveforms are now found in modern electronic devices. One example of exact timing is in the keyed agc system. The agc keyer must have both the video signal at its grid and the flyback pulse at its plate, with correct timing, in order to develop agc voltage. The correct relationship and timing of these signals is shown in Fig. 3.

The color section of the TV receiver must have accurate pulse timing for proper operation. The color burst amplifier stage separates the transmitted burst signal from the composite video signal and must be keyed on precisely at the right time by the flyback pulse. The 3.58-MHz burst is present on the back porch of the horizontal blanking pedestal and has a 0.2- $\mu$ s duration. Thus burst and keying pulse timing is very critical. If the

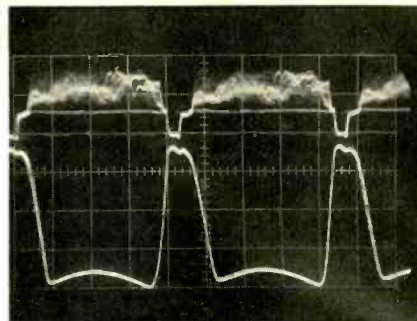

FIG. 3—KEYING PULSE and video signals must have this relationship for good agc action.

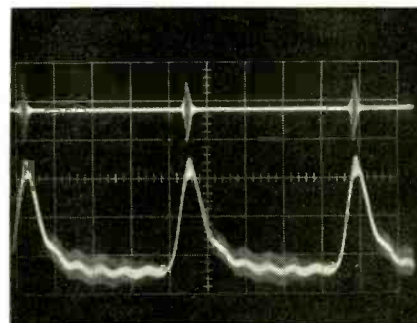

FIG. 4—COLOR BURST at burst amplifier plate compared to keying pulse on amplifier grid.

color receiver has poor or no color, use the dual-trace scope to check the color burst gate circuit. The scope photo in Fig. 4 shows the correct timing of the keying pulse at the grid of the keyer tube and the 3.58-MHz burst on the plate.

For a receiver that displays incorrect color, connect the two scope probes (one for another scope channel) to the demodulator grids for a phase check of the 3.58-MHz CW demodulating signals. Compare both signals for proper phase angle. If the phase angle is not correct look for a fault in the phase-shift network.

The dual-trace scope is also handy for checking the delay line in the video amplifier section. Tune the set to a TV station and use the horizontal sync pulse as a reference. Connect amplifier A of the scope to the delay line input and amplifier B to the output terminal. Switch the scope to alternating sweep and the horizontal time base to 2.5- $\mu$ s per division. Also use the expanded sweep, if the scope has this feature. Now, compare the leading edges of the two sync pedestals as shown in Fig. 5 and note, as in this case, the correct 0.7- $\mu$ s time delay. This is a fast way to check the delay line action.

### Stereo troubleshooting tips

Now let's use the dual-trace scope for some stereo channel-comparison testing techniques. The basic concept of this method is to compare the operative channel with the inoperative channel. With this system a very rapid procedure can be developed to pin



point defective components for all types of stereo amplifier and multiplex FM systems.

The triggered dual-trace oscilloscope along with a square-wave audio generator are the instruments used to make these following checks. Of course, these techniques can be used for solid-state or tube-type stereo equipment.

To use this technique one of the amplifier channels must be operating correctly so you can compare waveforms with the defective one. Both waveforms may then be superimposed for an exact analysis and even minor distortions can easily be detected. When both channels are working correctly you see identical twin images of the two square-wave traces on the scope screen.

Before these scope checks are made some routine tests of the stereo amplifier will have to be performed. These initial checks include current drain, faulty or overheating transistors, burnt resistors, loose solder connections and cracked or broken circuit boards. Frequently, after these checks and necessary repairs are made, one of the amplifier channels will operate correctly.

Shown in Fig. 6 is a block diagram illustrating a dual-trace scope and square-wave generator connected to a stereo amplifier to perform these

comparison testing techniques. The tests are begun by feeding the square-wave test signal into the left and right amplifier input channel jacks. The left and right channels are actually tied together. Tune the square-wave generator to 1 kHz initially. Now, the probes from channels A and B of the dual-trace scope are connected to the same, but opposite test points of the stereo amplifier's left and right channels. The two sets of square-waves on the scope are then compared for any discrepancy.

### Tracking down the trouble

One channel of this stereo amplifier (Fig. 7) had developed a very low volume level. The square-wave generator and scope were connected for a few checks. When the probe from channel A of the scope was touched to the collector of Q402 and probe from channel B was placed at the base of Q403 the scope pattern in Fig. 8 appeared. Note the loss of signal gain in the lower scope trace. A defective coupling capacitor (C415) caused this loss of gain. This same technique is also useful to compare stereo multiplex signals. To quickly isolate the fault just put the scope probes at the various stages and evaluate the scope traces. Start at the amplifier input and work up stage-by-stage to the speaker. When the signal is lost or becomes

very weak the preceding stage must be checked. Each time you move up one stage the amplifications should increase in level, but don't be fooled by gainless stages such as cathode or emitter followers as they add no voltage gain to the signal.

### Rapid isolation of intermittents

Here is a way to use the dual-trace scope to isolate intermittent circuit faults. The volume of a stereo amplifier may go up and down occasionally or an intermittent distortion condition could be the complaint. Some of these amplifiers may operate for days before acting up. This method can help solve those intermittent conditions. Start by feeding a square-wave signal into the suspected channel and connect both scope probes to different sections of the amplifier as shown in Fig. 9. Now, when the trouble develops just look at the scope pattern and if no change takes place move the probes to other sections.

This technique was used on the stereo amplifier shown in Fig. 7. The dual-trace scope was connected and the fault was isolated to an intermittently open coupling capacitor. This was C412 at the base of Q402. This was found when one probe from the scope was connected to the high side of the bass control and the other

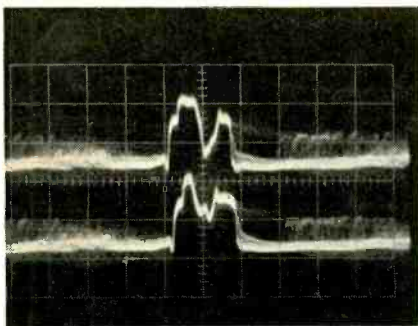

FIG. 5 (above)—DELAY LINE CHECK. Bottom trace of horizontal sync pulse is delayed 0.7  $\mu$ s, proving that line is OK. FIG. 7 (below)—ONE CHANNEL of stereo amplifier tested.

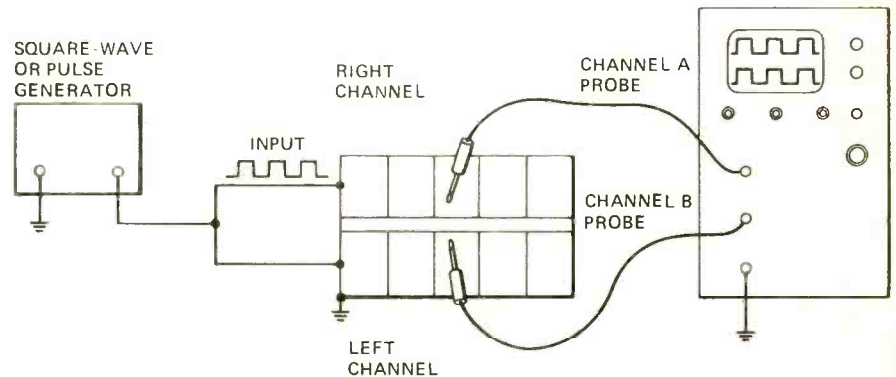
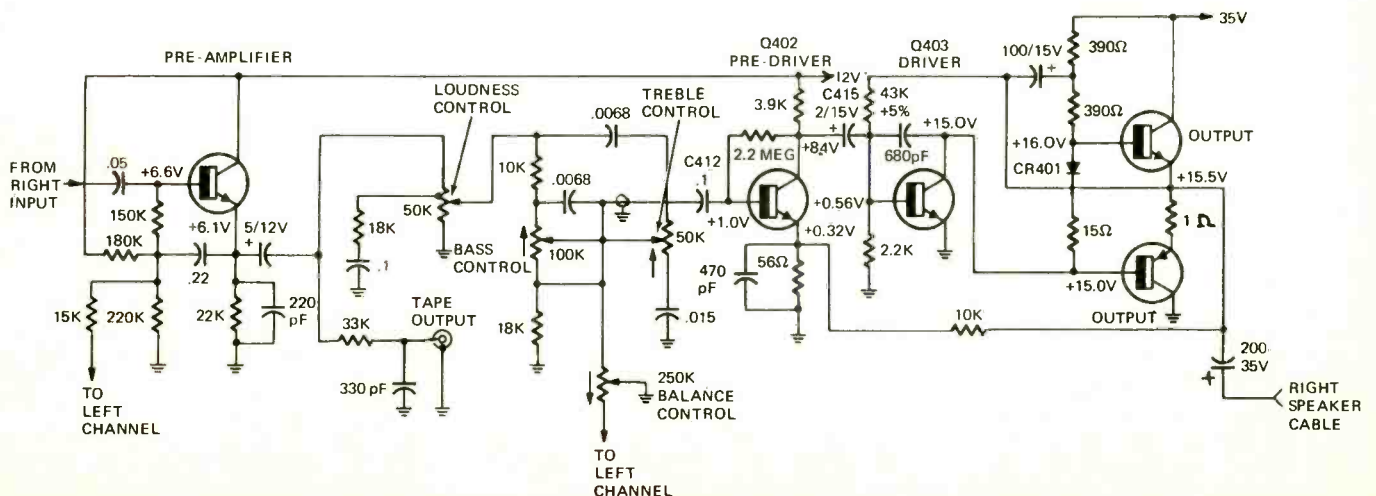

FIG. 6—BLOCK DIAGRAM showing how a dual-trace scope can be used to track down intermittents and other defects in a stereo amplifier. Dual traces make it easy to compare channels.



# RCA Institutes introduces the CASSETTE SYSTEM

## **It's almost like having an instructor in your own home.**

Now, another breakthrough from the company that brought you AUTOTEXT, RCA's step-by-step home learning method! It's the new RCA Institutes' CASSETTE SYSTEM, an innovative learning-by-hearing approach designed to get you started more quickly and easily towards an electronics career. The CASSETTE SYSTEM adds an extra dimension to AUTOTEXT, RCA's step-by-step planned instruction which simplifies the mechanics of learning. As you play the cassette tapes, you'll have an instructor guiding you through your AUTOTEXT lessons. Explaining the material as you read it. Going over schematics with you, reinforcing the basic electricity and electronics study materials. All in an easy-to-understand conversational tone. And now the CASSETTE SYSTEM is available as an optional extra to all students enrolling in basic, fundamental, and career programs.

### **"HANDS-ON" TRAINING**

In addition, you get the all-important "Hands-On" training, an enjoyable as well as instructive part of many RCA Institutes courses and programs. You will perform experiments and build a number of pieces of electronics test equipment that you can keep and use. In the Master TV/Radio Servicing program you build and keep an all solid-state black & white TV set, a color TV set, oscilloscope and multimeter. With the addition of tape cassettes, you get an expert personal touch that can unravel the complexities of basic electronics.

### **CHOOSE FROM EXCITING CAREERS**

Whether your career goal is Radio/TV Servicing, Digital Technology, Communications or Industrial Electronics, RCA Institutes has the course or career program that can lead to it. The RCA way gets you started towards that exciting career with the training you might have thought was too expensive, too drawn-out, or too hard to learn.

### **NO SALESMAN WILL CALL**

If you're interested in an exciting rewarding career in electronics, send the attached card or fill in the coupon. We'll send you all the information you'll need to discover which RCA course or program is for you. No salesman will call.

Don't let this opportunity to find out about RCA Institutes' training for an electronics career pass you by. The sooner you write, the closer your new electronics career may be.

# An exciting concept - - new in RCA Institutes' electronics home training

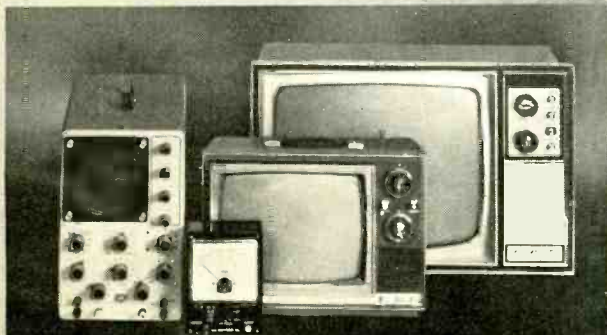
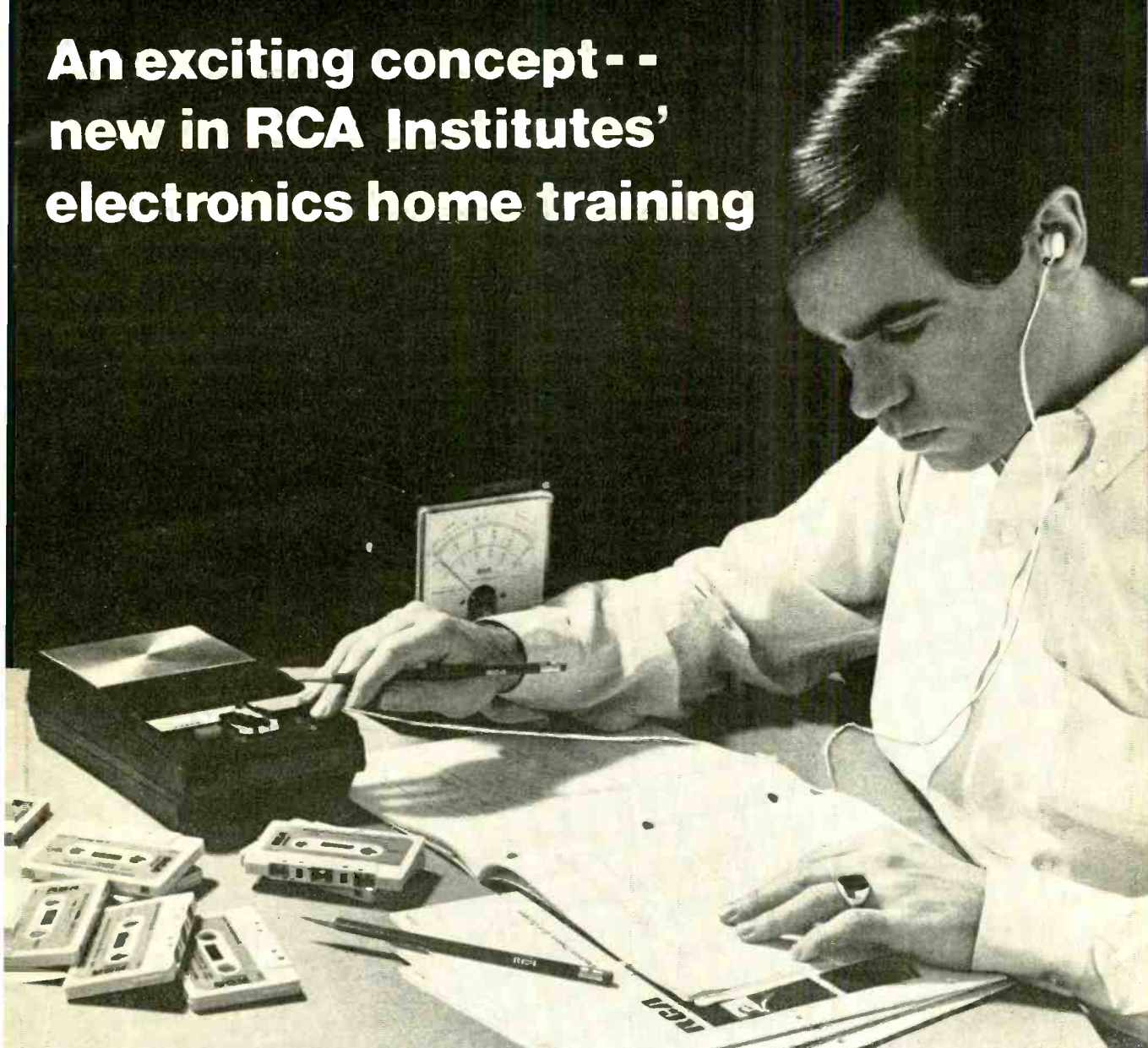

In the Master TV/Radio Servicing Program, you build and keep the all solid-state black and white TV set, the color TV set, the oscil oscscope and multimeter shown above.

## **RCA** Institutes

756-302-0

RCA Institutes, Inc.  
Home Study Dept.  
320 West 31st Street, New York, N. Y. 10001

Please rush me FREE illustrated catalog.  
I understand that I am under no obligation.

Name \_\_\_\_\_ Age \_\_\_\_\_  
(please print)

Address \_\_\_\_\_

City \_\_\_\_\_ State \_\_\_\_\_ Zip \_\_\_\_\_

Check here if interested in Classroom Training

Veterans: Check here

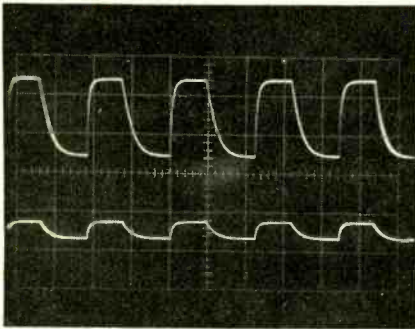

FIG. 8—LOW AMPLITUDE of one trace shows a loss of signal somewhere between the two probes.

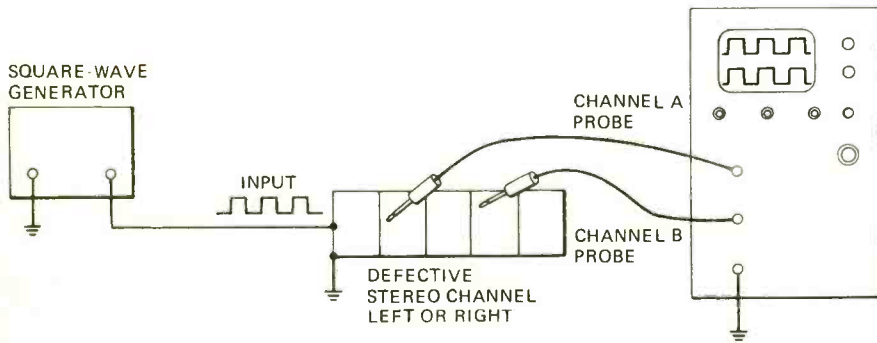

FIG. 9—SIGNAL TRACING in single channel of an amplifier is easy with a dual-trace scope. One scope channel views input signal; the other checks the signal stage-by-stage.

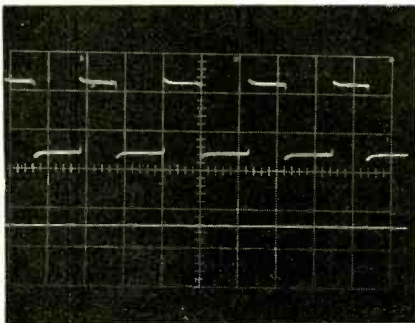

FIG. 10—SQUAREWAVE TEST SIGNAL at input; the straight line shows a loss of signal.

probe at the base of Q402. When the defect occurred we got the scope trace shown in Fig. 10. It doesn't take long to isolate an intermittent problem this way.

But if the intermittent is within a multi-stage feedback amplifier, this technique will not work unless the feedback loop is opened first.

In the example of Fig. 7, the defective capacitor (C412) was at the input to a three-stage feedback loop. This isolation technique would not have worked if C415 or C420 was intermittent.

With this technique you can quickly isolate the problem right down to the defective component. As a final check of the amplifier or if you suspect inadequate frequency response, use the square-wave generator and tune it throughout the audio range of the amplifier. Make these checks at about 1-kHz intervals and view both channels on the dual-trace scope at the same time. The frequency re-

sponse of a stereo amplifier can readily be checked with this system.

### Stage gain comparison measurements.

Modern dual-trace triggered scopes have identical vertical amplifiers and their gain is calibrated in volts per centimeter (volts/CM). This makes an ideal instrument to check one stereo channel against the other one to compare the signal gain of various stages. This can be used for checking the gain per stage throughout

the amplifier and for overall performance of the left and right channels. This makes it very easy to compare the left amplifier with its twin on the right.

The dual-trace scope can also be used to simultaneously monitor the input and output signal of any type of electronic processing stage, whether it be oscillating, amplifying, switching or isolation, solid-state or tube type. Because of the ac or dc vertical amplifier mode of operation of these scopes the peak-to-peak ac signal level along with the dc voltage level can all be seen with just one glance at the scope screen.

Thus, you can double your pleasure in many instances by actually cutting your troubleshooting time almost in half.

The dual-trace triggered oscilloscope is invaluable for rapid troubleshooting of today's sophisticated solid-state space age electronic devices.

R-E



"The repairman wants to know if it's two-channel or four-channel!"

### BATTERY SAVER

Battery-powered instruments are fine—except that if you are like us, you often forget to turn off the ones without the ever friendly and reassuring pilot light. This results in run-down batteries it seems, just when you need them most. Things sometimes get so bad that I forget to unplug the soldering irons at the end of the day. If it was not for plated tips, I would have had to spend a small fortune replacing burned-up tips.

In desperation I made several small battery-powered neon relaxation (RC) oscillators (Fig. 1) that I turn on

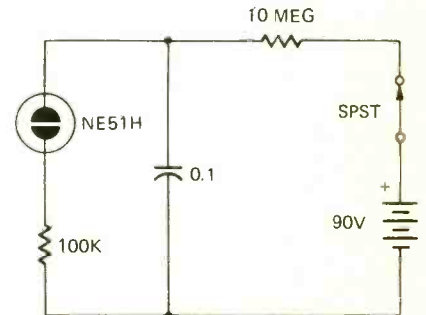

FIG. 1

whenever I turn on a battery-powered instrument. These are located strategically throughout the shop so that the blinking neon lamp is a reminder that a battery-powered instrument is on. The operating life should equal the shelf life of the batteries. Mine have been operating for over two years.

The soldering iron problem I solved in an equally simple manner. A neon lamp assembly wired in the soldering iron stand (Fig. 2) lights to

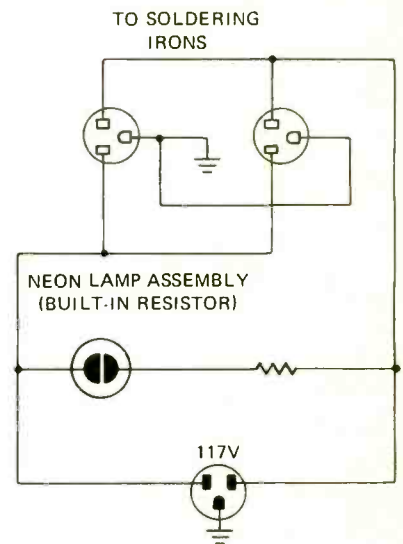

FIG. 2

show that the stand and soldering iron(s) are plugged in.

These may seem like a lot of work to solve simple problems, but they save in frustration and replacement costs!—William D. Kranengel, Jr.

# GRINCHWAL READOUT MODULE

Complete your mainframe. Build this 4-digit readout assembly using LED's and get ready for the plug-ins that follow

by DON LANCASTER

HERE'S A FRESH, HIGH PERFORMANCE approach to digital counting and display—combine a bright red light emitting diode (LED) display with a *single* new high performance, MOS Integrated Circuit, and you come up with an easy-to-build *four decade* 0-9999 digital counter and display that neatly fits a single 2½" x 5¼" plug-in PC card. Total supply current, including the readouts, is a mere 6 volts at 100 mA, easily provided by ordinary flashlight cells. Now you can go truly portable with your digital instruments, free of any line cords, bulky storage batteries, or high-voltage display supplies. While the maximum counting frequency of this display is 250 kHz, you can easily count to 100 MHz and beyond by suitable scaling.

Figure 1 shows a simplified block diagram

diagram of the counting module. Practically everything is crammed inside the single *Mostek* MK5005 integrated circuit. *Monsanto* MAN-4 light-emitting-diode (LED) displays are used. These are a fifth of an inch high and readable beyond eight feet. Brightness is good enough for almost any reasonable room lighting, and you can even hold back on brightness to extend the battery life and still come up with a highly viewable display.

## Construction

Figure 2 shows the actual circuit. Darlington driver transistors are needed to get the IC outputs up to a suitable level for display drive. These are npn or npn transistor pairs as shown and have gains in the ten thousands. They cost 45 to 60¢ each. Ordinary

transistors, even high gain ones, may NOT be substituted.

Capacitor C1 sets the scanning rate for the multiplexing while C2 gives a speed-up to the decimal point input that eliminates ghost decimal points. Feedback from the decimal point driver to the chip controls the leading zero blanking.

Brightness is controlled by resistors R2 through R9. The values shown are the *minimum* recommended values that give *maximum* display brightness. If desired, the resistors may be raised in value to give a not as bright display that has longer battery life.

A printed-circuit board is a must for this project. You can get one commercially or else you can use Figs. 3, 4 and 5 to make your own.

While the MOS integrated circuit

FIG. 1—DISPLAY MODULE BLOCK DIAGRAM. Single low-power integrated circuit does the job. It replaces more than a dozen conventional ICs.

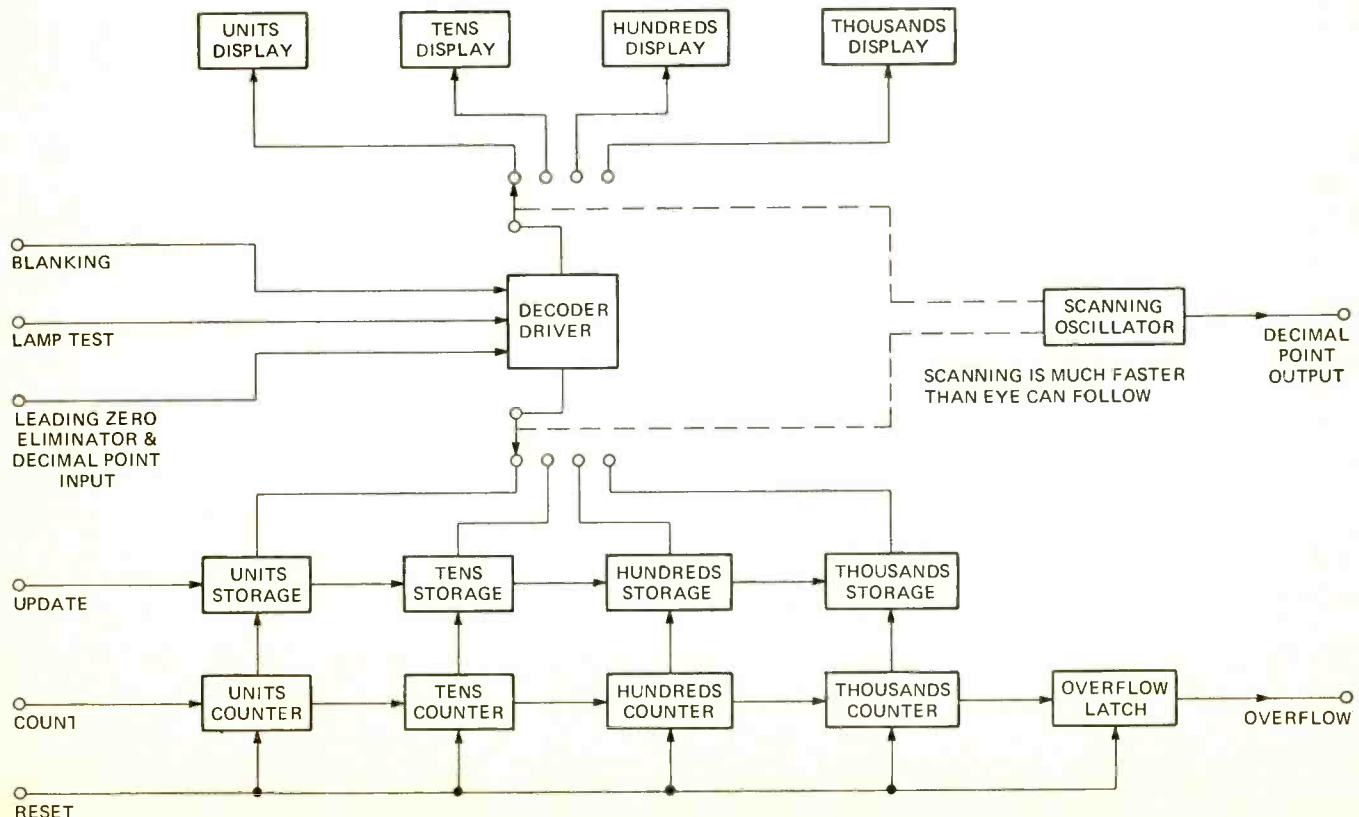

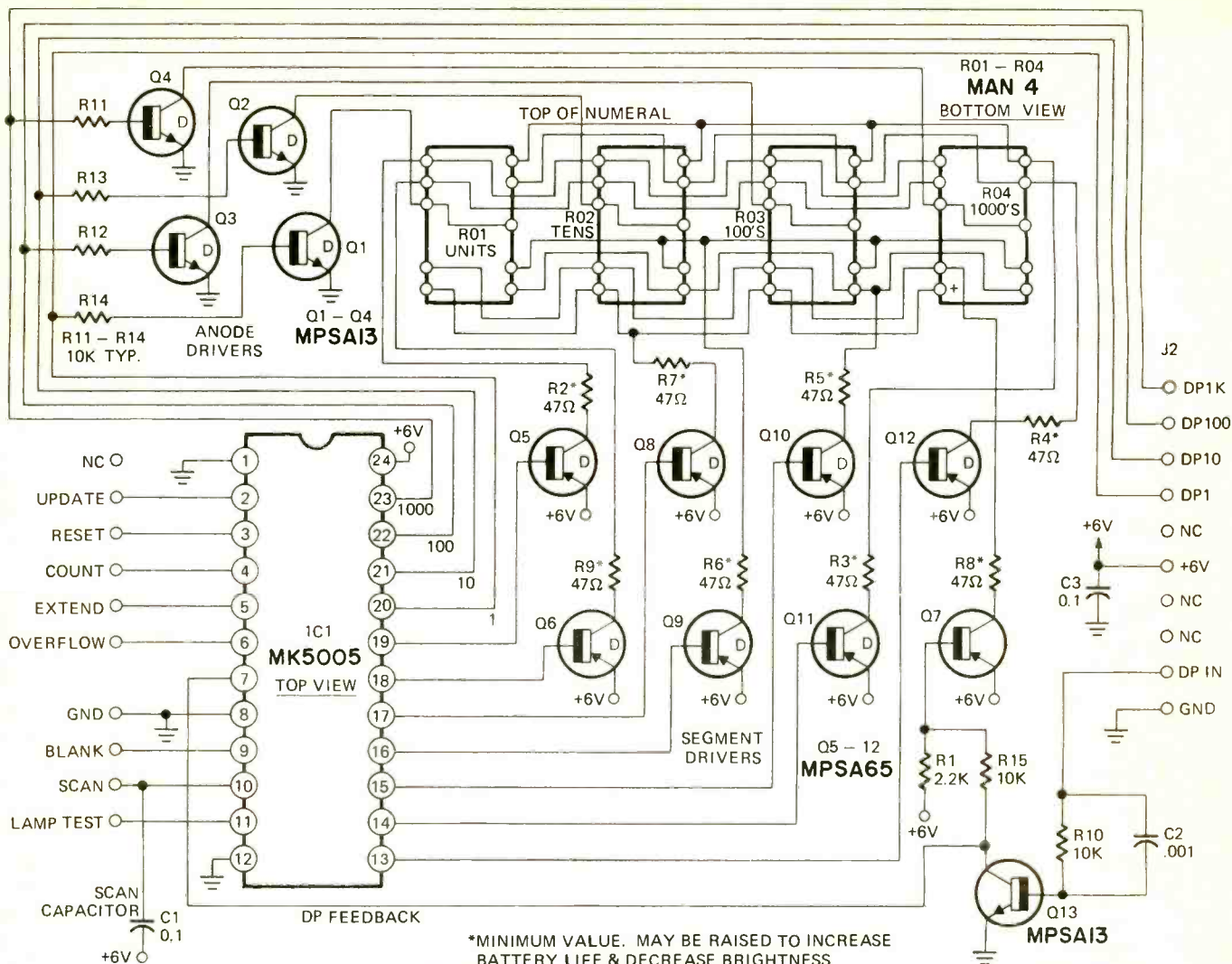

FIG. 2—(above) COMPLETE schematic of the readout circuit.

FIG. 3—(bottom right) FOIL PATTERN of the readout board is 5¼ x 2½ inches.

FIG. 4—(right) PARTS PLACEMENT for the readout board.

is now pretty well protected against static and overvoltage, REVERSED SUPPLY POLARITY WILL IMMEDIATELY AND PERMANENTLY DAMAGE THE DEVICE. IN ALL OF YOUR CIRCUITS AND ALL OF YOUR CHECKOUT WORK, A SERIES DIODE OR OTHER "IDIOT PROOFING" MUST BE PLACED BETWEEN THE MODULE AND THE SUPPLY.

Before starting assembly, note three very important details: (1) don't unwrap the MOS integrated circuit or remove its protective foam until immediately before you solder it in place; (2) note that the readouts mount foil side, opposite the rest of the components; and (3) note that the pins on the plug in connectors stick out from the component side, opposite to the foil side that supports the readouts.

A deep red optical filter is absolutely essential for proper display contrast. A piece of ¼" red plexiglas

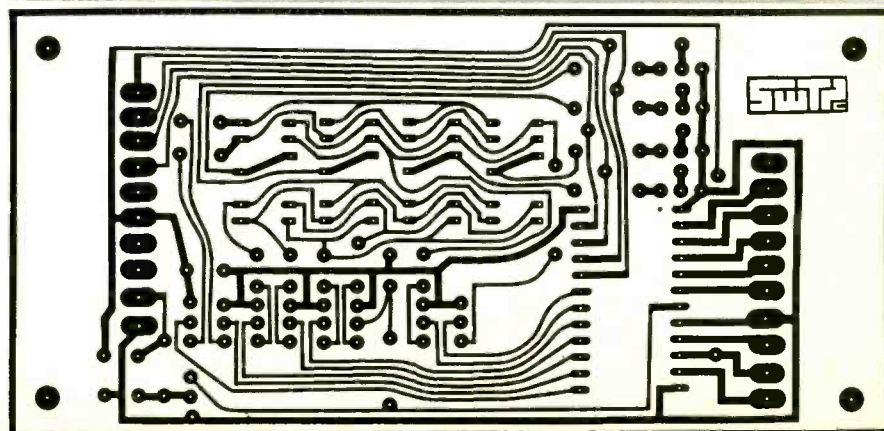
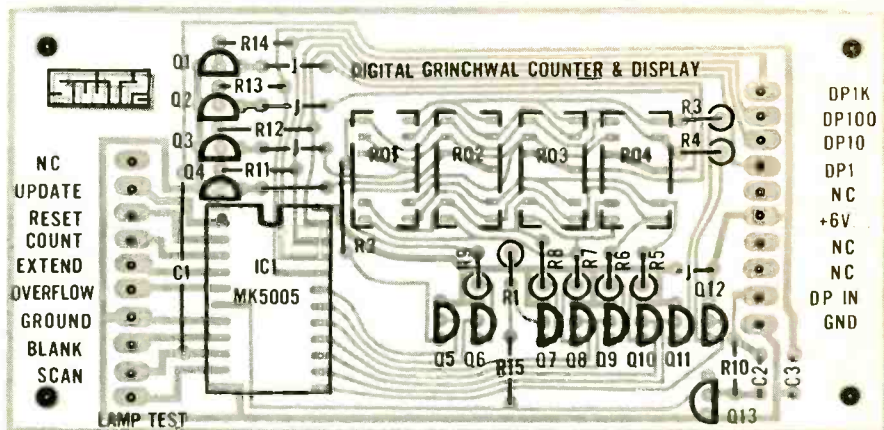

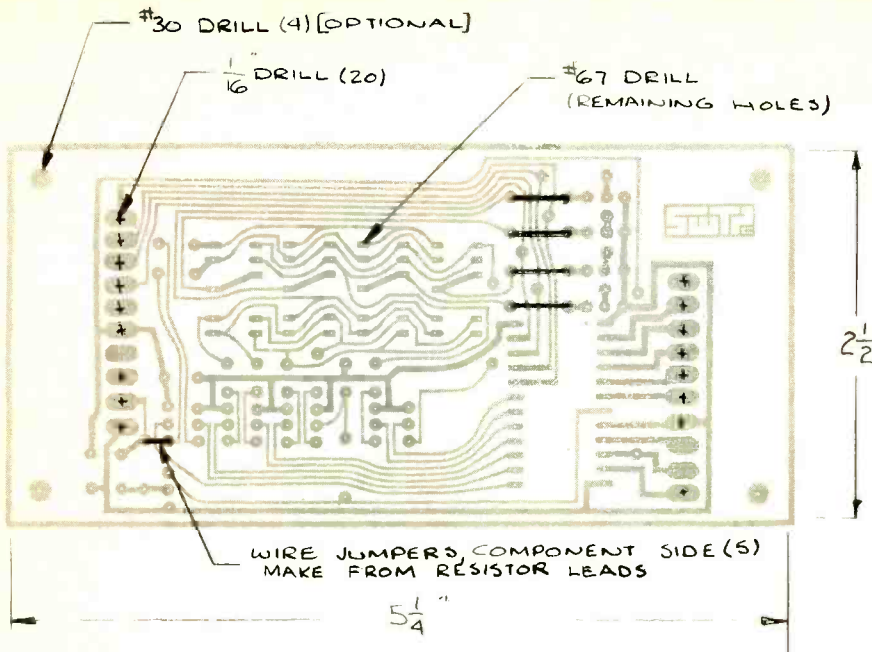

- PARTS LIST (Fig. 2)**
- R1—2200 ohms, ¼ watt, 10%
  - R2, R3, R4, R5, R6, R7, R8, R9—47 ohms, ¼ watt, 10% (see text)
  - R10, R11, R12, R13, R14, R15—10,000 ohms, ¼ watt, 10%
  - C1, C3—0.1- $\mu$ F disc ceramic
  - C2—1000 pF disc ceramic
  - IC1—MK5005P (Mostek) DO NOT SUBSTITUTE
  - J1, J2—10-pin male connector (modified Molex 09-57-1105)
  - Q1, Q2, Q3, Q4, Q13—MPS A13, npn Darlington transistor pair (Motorola) DO NOT SUBSTITUTE
  - Q5, Q6, Q7, Q8, Q9, Q10, Q11, Q12—MPS A65, pnp Darlington pair (Motorola) DO NOT SUBSTITUTE
  - RO1, RO2, RO3, RO4—MAN-4 LED seven-segment readout (Monsanto)
  - MISC: PC board; 5 jumpers; red filter, 1¼ x 2½ x ¼" #2423 Plexiglas; sockets for J1 and J2, Molex 09-52-3103
- NOTE: The following are available from Southwest Technical Products, 219 W. Rhapsody, San Antonio, Tex. 78216.**  
 Etched & drilled circuit board—DGR-b, \$3.85.  
 IC1—\$20  
 Kit of all parts—DR-c, \$34.50

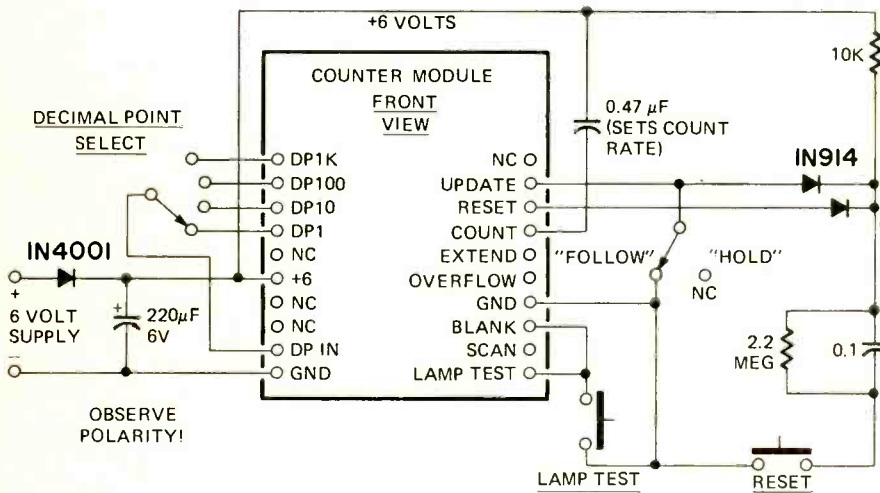

- PARTS LIST (Fig. 7)**
- R1, (R2\*)—100 ohms, ½ watt, 10%
  - C1—5000  $\mu$ F, 10V, electrolytic
  - C2, C3—500  $\mu$ F, 25V, electrolytic
  - C4\*—500  $\mu$ F, 6V, electrolytic
  - D1, D2, D3, D3—1N5061 silicon diode
  - D5—1N4742, 12V, 1W, Zener diode
  - D6\*—1N4736, 6.8V, 1W, Zener diode
  - F1—0.1 A fuse and fuseholder
  - Q1\*—2N5191 npn silicon transistor
  - T1—transformer: primary, 117Vac; secondary, 12.6V, 100mA with ct
  - \*Regulator: A Fairchild No. 7806 regulator may be substituted for these parts.
  - MISC: PC board, line cord, strain relief terminals, mounting hardware
- NOTE: The following items are available from Southwest Technical Products, 219 W. Rhapsody, San Antonio, Tex. 78216.**  
 Etched & drilled circuit board—DRP-B, \$2.50  
 Kit of all parts—DRP, \$8.75

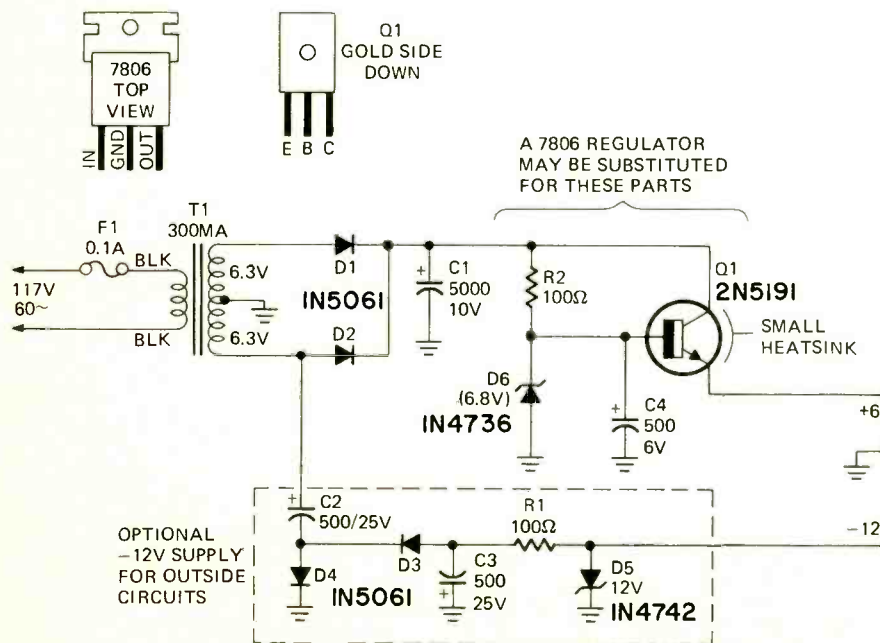

#2423 is ideal for this and may either be bolted directly to the module (using long enough spacers to clear the readouts) or the filter may form a front window for a display or instrument package.

### Using it

The module may be powered from a six volt unregulated supply, four D cells, or a regulated supply. One suitable line operated supply is shown in figure seven. This particular supply also puts out -12 volts which is handy for a companion time base chip, the MK5009, or for other external circuitry.

The display goes out before the counter quits. If ultra-long battery life is essential, you can reduce the brightness by increasing the values of R2 thru R9 to perhaps to 220 ohms, or to whatever tradeoff between battery life and brightness you want. Or, you can go to alkaline D cells or NiCad's. Ordinary heavy-duty D cells should last you around 40 hours of intermittent operation.

R-E

FIG. 5—(top) DRILL AND JUMPER GUIDE for the readout circuit board. FIG. 6.—(middle) TEST CIRCUIT for breadboarding initial checkout. FIG. 7.—(bottom) RECOMMENDED POWER SUPPLY for ac operation. For portable use simply use four "C" or "D" cells connected in series.

# low cost keyboards

Flexible, versatile, medium duty, professional quality keyboards are yours for a quarter a key and customized to your particular needs

by DON LANCASTER

WHAT COULD YOU DO WITH A LOW-cost keyboard? Besides such traditional uses as adding machines, ham radio-teletype and automatic Morse-code senders, electronic security locks, etc., there's a whole new world of wonderful new integrated circuits that open the doors to a wide range of new projects. Projects that right now aren't practical because commercial custom keyboards are too expensive and too hard to get in small quantities.

For instance, you can now get MOS calculator chips for less than \$16. This and a low-cost keyboard and a display gives you an add-subtract-multiply-store calculator for way under the going price. Or, one keyboard, an encoder, and a coupler buys you one half of a computer terminal you can call up your timesharing service with—at a tiny fraction of commercial unit or rental costs.

Low-cost keyboards also open the doors to programmable calculators, sports car rally computers, computer data entry, and such new blue-sky projects as cable television "answer back" systems, electronic notebook and message centers, communications aides for the deaf, sophisticated electronic security devices, elaborate electronic games, programming for music composers and synthesizers, teaching machines, tape or cassette file search systems, credit card verifiers, inquiry systems, recipe, bibliography or literature data banks. "anti-drunk driver" gadgetry, and many, many others.

But, commercial custom keyboards are expensive. Normally, you pay 80¢ to \$2 per key for a 12- or 16-key assembly, and as much as \$6 per key for a fully-encoded teletypewriter style keyboard. Surplus is a help, but only if you can use the keyboard as is. And the "Let's use pushbuttons!" route usually ends up with hard-to-read characters, harder operation, and impossible wiring.

Yet, for a few nickles worth of materials, you can build yourself a custom medium-duty keyboard set up for your particular task.

We'll show you how to build two

keyboard versions here. The first is a 12-key version for calculators, electronic security locks, Touch Tone systems, or data entry. The second is a full 55-key teletypewriter-style keyboard for computer terminals, communication systems, and deaf listening aides. A later article will show you a low-cost ASCII encoder that converts the contacts of the big keyboard into an eight-bit parallel IC logic-compatible standard computer code. Along with this, we'll show you a 100 word-per-minute adaptor. Together the keyboard, encoder and adaptor can give you a complete sending end of a teletype style computer terminal for a fraction of the usual rental or purchase price.

## How it works

Figure 1 is a cross section of one keyswitch. We use a 1/4-inch thick soft carbon-urethane sponge contact. The contact is made by pressing the foam

ating force of 3 to 5 ounces. This is low enough for the keyboard to talk to virtually any integrated circuit logic system without any buffering or isolation. It is also smooth enough to give "soft start" click-free contacts for electronic music operations. While the key travel is typically 3/16-inch, you can easily make it anything you want. There's also a definite increase in mechanical force well *after* contact is made, so for most applications, you can easily tell when contact has been made, particularly if you have a display alongside you can watch. Optional "clickers" of one sort or another can be added if they are absolutely needed. The assembly is reasonably thin, projecting only 13/16-inch behind the keybottom. I used standard, commercial two-shot molded keytops. These are white on grey and are available in a wide variety of characters, numerals, and punctuation. Blank and oversize keys are also available. The

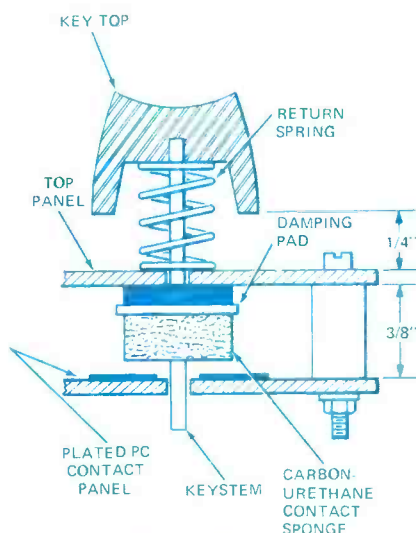
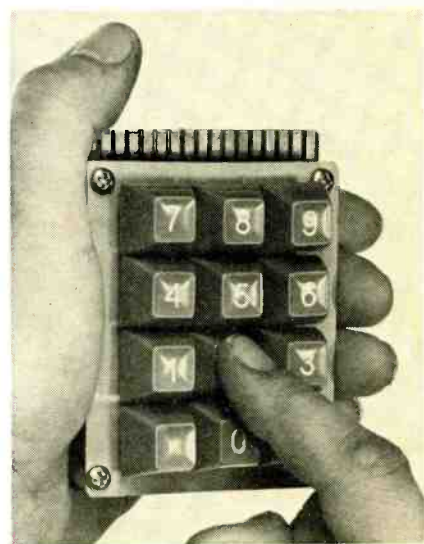

FIG. 1—INDIVIDUAL KEYS are made from a few easily obtained components.

against a pair of plated contacts on a printed circuit board. This system generates very little switch noise and bounce, as the sponge particles progressively make and bring about a smooth change from an open circuit to a low resistance. ON resistance is usually under 500 ohms for an oper-



CALCULATOR KEYBOARD ready for mounting. Note the printed-circuit connector.

two-shot molding process means the character goes all the way *through* the keytop. It cannot wear off, come loose, or change color. Conventional springs and an optional damping pad return a pressed key to its home position. Optional *Belleville* washers or a snap-action strip of polypropylene can be





added for snap-action or tactile feedback, but this only adds to the cost and complexity for most users.

The parts are detailed in Fig. 2. A *keystem* assembly is made up of a piece of  $3/64 \times 3/16 \times 1/4$ -inch solderable soft steel and a  $17/32$ -inch disc of light gauge solderable steel. Be sure the part of the keystem that goes into the keytop is cut to fit tightly. You should *lightly* centerpunch 4 or 5 "pockmarks" on each side of the very top of the keystem, or else glomp on a small self-grip locking plier-wrench heavy enough to cut in teeth marks. This helps lock the keytop firmly in place during final assembly.

The disc is soldered to the keystem exactly as shown in Fig. 2-a, keeping it positioned exactly  $13/16$ -inch from the keytop end and keeping the solder only on the keypad end. A small wood or other non-heat-conducting jig is absolutely essential during soldering. A simple one is shown

in Fig. 2-b. The disc *must* be perfectly square with respect to the keystem. Immediately before soldering, carefully clean both pieces with a typewriter style ink eraser to guarantee the solder will smoothly and strongly adhere. Liquid rosin solder flux helps greatly, but isn't essential. As with any electronic assembly, don't use acid core solder or flux.

After soldering, remove all excess solder with a  $1/8$ -inch diameter *round* file, and smooth and polish all edges. Also remove any remaining flux.

Press a slit  $0.4 \times 0.4 \times 0.25$  inch piece of carbon urethane onto the keystem. You might like to *optionally* glue it to the keydisc. If you do, use an absolute minimum of adhesive and be sure not to fill any of the sponge voids. The glue really isn't necessary. The carbon-urethane foam may be obtained from the source listed, or you can use the foam many MOS integrated-circuit manufacturers wrap

their IC's in for shipment. If you're using the free material, check several companies, for some of the material is more suitable than others. A good material will be soft yet still give 500 ohms or less resistance, and it won't crumble or tear. Be absolutely sure that the keypad sponge is centered and square with respect to the keystem.

Two  $1/16$ -inch panels support the switches. These are spaced  $3/8$  inch apart using 6-32 threaded spacers. Since the keystem is a conductor, both panels must be insulators *except* where contact is to be made. Use an ordinary  $1/16$ -inch single-sided printed circuit board for the bottom panel, contact side up; and an etched-off piece of PC material or other  $1/16$ -inch fiber glass for the top panel.

Be sure to follow these guidelines in your PC layout. Keys are normally  $3/4$ -inch apart. The contact areas should be  $0.4$ " square total, with enough clearance between both contact halves and the keystem. Conductors between the contact pads should be small enough and centered enough so that a slightly misaligned keypad can't cause an unwanted short. With a calculator or telephone style keyboard, the rows of keys are usually centered on top of each other. With a typewriter style keyboard, the rows are usually offset to allow normal typing. Normally you'll also want to provide a PC edge-card connector on your layout for system interconnection. While you can go to multiple contacts and self-encoding keys, this does add complexity and

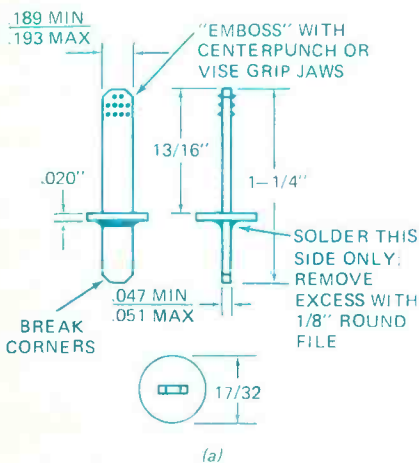

KEYSTEM IS MADE BY SOLDERING A STEEL DISC & STRIP TOGETHER

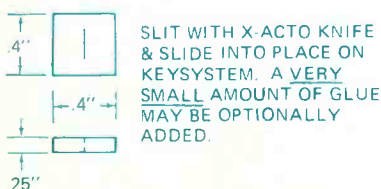

CONTACT PAD IS MADE FROM  $1/4$ " CARBON URETHANE FOAM. SLIT SHOULD BE ACCURATELY CENTERED.

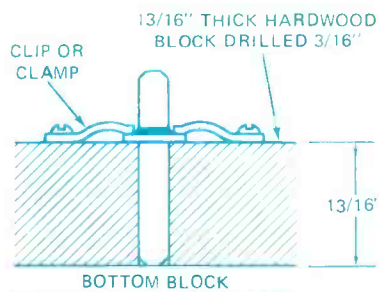

USE A JIG LIKE THIS FOR SOLDERING

**FIG. 2—HOW KEY IS MADE.** Construction of the keystem is simple and well within the abilities of most technicians and experimenters. Care and precision insure a reliable keyboard.

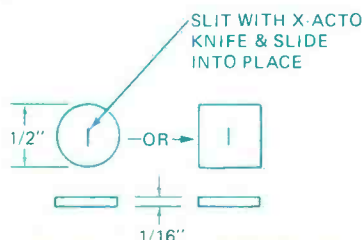

DAMPING PAD IS MADE FROM  $1/16$ " THICK INNERTUBE STYLE RUBBER.

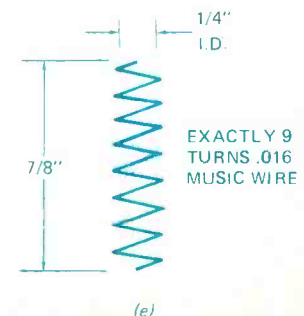

SPRING LOOKS LIKE THIS. START WITH AN EXTENSION SPRING. STRETCH IT & CUT EVERY NINTH LOOP

might be difficult to do on a single-sided board.

Holes for the keystems are moderately critical, and the bottom and top panels must be match-drilled or match-punched in their exact final position. Start with the bottom panel, foil side up and either punch or drill and file rectangular holes for each keystem. The holes should be large enough to allow the keystem to slide freely by, but not so large that the keystem can rotate excessively. Edges should be beveled slightly. After the PC panel is punched, drill the mounting holes and firmly bolt the top and bottom panels together *backwards*, so the drilled panel is on top and the un-drilled one is on the bottom. File notch across both panels to indicate their alignment for final assembly. The top panel can then be match-drilled or match-punched to the bottom. This way, all the keystems are perfectly vertical and freely slide after final assembly. If you try to drill top and bottom separately, some of the keystems are sure to bind or be crooked.

The return springs may be chopped out of larger hardware store springs, or wound with music wire. The inside diameter should be somewhat over 0.2 inch. The uncompressed length should be around 3/4 inch and the spring should squash beyond 1/4 inch without bottoming. Wire diameter is 0.16 inch. The restoring force should be around 3 ounces when compressed 1/4 inch and 6 ounces when compressed 1/2 inch. The ends should be wound or ground so they do not cut into the top panel or keytop when in use.

The bare copper contacts on the PC board must be protected against long term corrosion that will raise the contact resistance. Gold, nickel, or tin plating is ideal, but you can use ordinary silver ink "PC Repair" paint provided you thin it properly and bake it on. A better product is *Sel-Rex SIL-PAINT* 2065-01. It is thinned with denatured alcohol and brushed on. You then bake it in a kitchen oven at 200 degrees for two hours. The resultant carbon on silver contact is almost as good as gold plating and is far easier to do with limited equipment. Commercial keyboard kits are already plated.

During final assembly, you might like to add an optional damping disc that goes below the top panel and above the steel disc on the keystem. This pad can be about 1/16 inch thick and can be made of inerttube rubber or most anything similar. The pad quiets the keyboard operation, and shortens the keystroke. Changing the pad thickness lets you control the keystroke.

Be sure to polish, smooth and

clean everything during final assembly. A rough edge or a thumbprint can cause long term wear or contact resistance problems. Also check to be sure each keypad seats flat on its contacts. Assembly starts with the bottom panel and threaded bushings, followed by the keystems, the damping pads, and the top panel. These are all bolted together and operation is carefully checked. Once smooth operation is

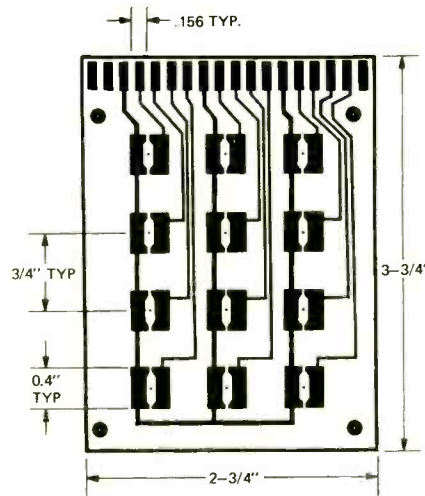
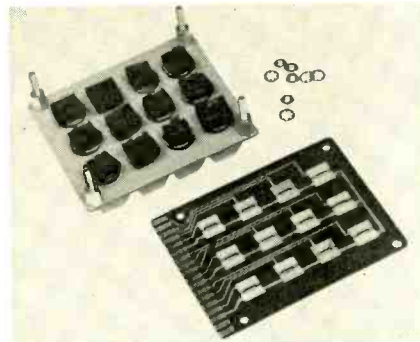

FIG. 3-PC PATTERN for a keyboard. Use extreme care when drilling holes for keystems.



DISASSEMBLED KEYBOARD showing keystems and the carbon-urethane sponge contacts.

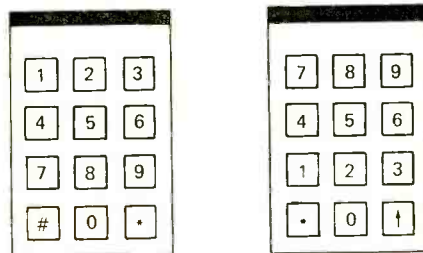
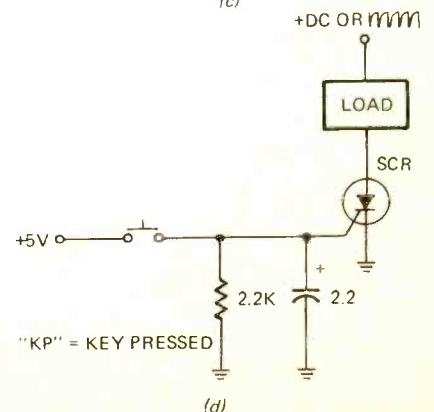
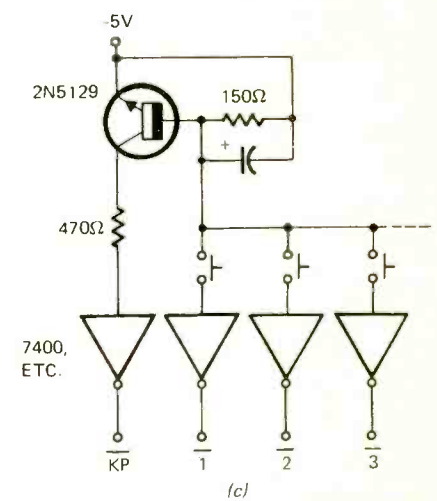
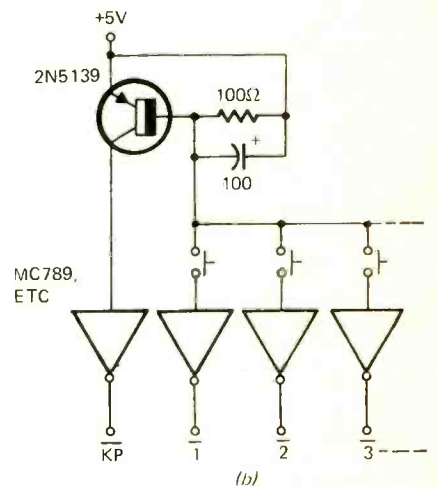
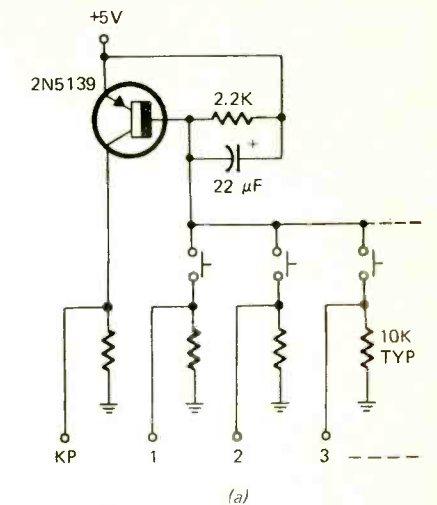

FIG. 4-TWELVE-BUTTON KEYBOARDS in the standard Touch-Tone and calculator formats.

obtained, the springs are added, followed by the keytops which are pressed on till they firmly seat. A tiny amount of silicone grease may be optionally added to the keystems. Keep

FIG. 5 (right)—WHEN A KEY IS PRESSED collector current flows in the transistor.



all grease well away from the contact areas.

### 12-key keyboard

The printed circuit pattern for the 12-button keyboard is shown in Fig. 3 and in the photo below it. One common connection is provided, but you can easily break this if you are using your contacts in a matrix form. You can arrange your keys any way you like, but

output does, be sure you use only the *leading edge* of your "key pressed" command. Should a second key be depressed before you let go of the first one, it will not be entered, giving you a form of "2-key-rollover" protection. If desired, an external speaker, solenoid, or Sonalert clicker may be added to the basic keyboard to provide additional operator feedback.

A standard 18-connector PC edge

conjunction with the American Standard Code for Information Interchange (ASCII). The key arrangement of Fig. 7 can be used, or you can set up your own. A cross-section of the keyboard is in Fig. 8.

The big keyboard is slightly more complex than the little one. Mechanically, extra spacers are needed to provide a "honeycomb" type of support all the way across the keyboard. Two

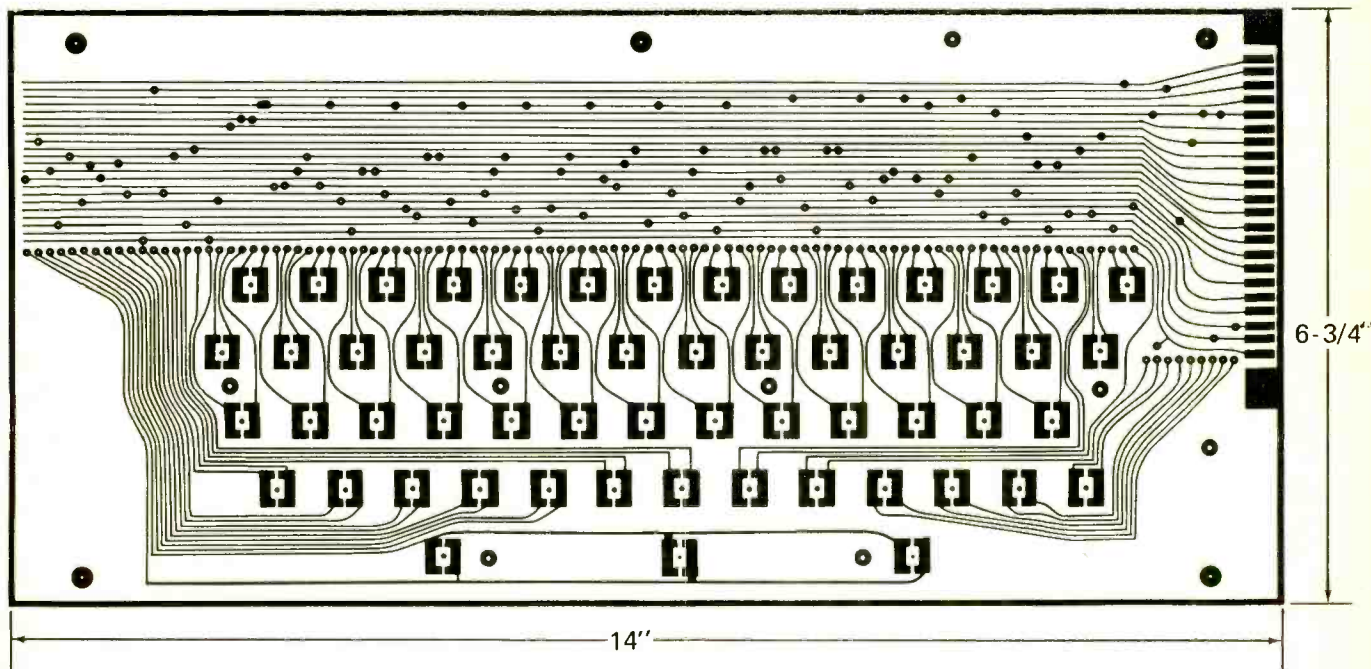

FIG. 6 (above)—PRINTED-CIRCUIT PATTERN for full 55-key typewriter or teletype keyboard. Each key has two contact pads connected to PC

lands. Add a jumper vertically from each key-contact land to the land that is directly above it in one of the 22 horizontal rows.

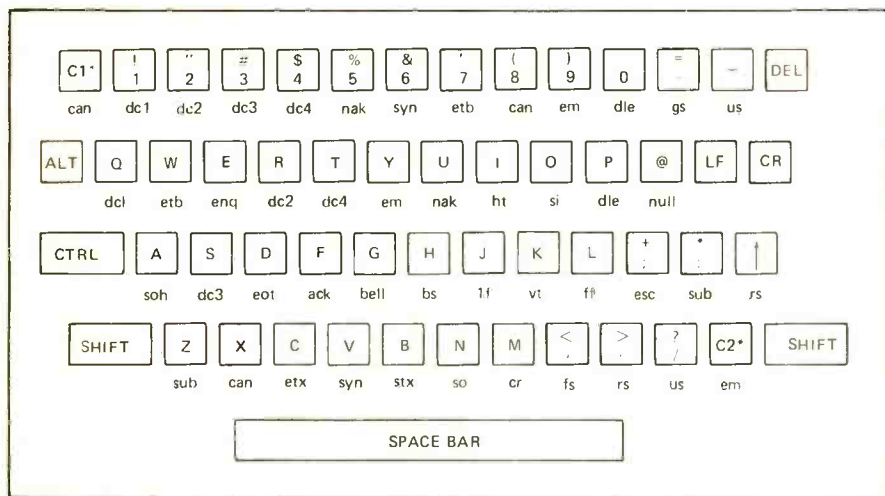
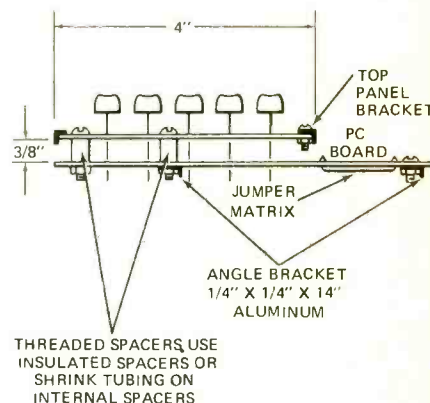

FIG. 7 (left)—TELETYPE KEYBOARD for ASCII computer code. Make yours anyway you wish. Fig. 8 (below)—CROSS-SECTION OF A COMPUTER KEYBOARD. Extra spacers provide stiffening.



two "standard" formats are the "calculator" and "Touch-Tone®" arrangements shown in Fig. 4.

Several "key pressed" systems are shown in Fig. 5. All are based on detecting a key being depressed by pulling base current through a common transistor. The large capacitor delays the key-pressed command long enough to insure a settled contact. Since the key lets go before the "key pressed"

card socket fits the keyboard. One suitable mating connector is the Amphenol 143-018-03.

### 55-key typewriter keyboard

The full typewriter or teletype style keyboard is shown in Fig. 6, and in the head photograph. This particular keyboard is modeled more or less after the ASR-33 teletype, the "standard" computer entry device used in

aluminum angles run the length of the bottom panel for added rigidity. The progressive rows of keys are offset from each other just as an office typewriter is. A long spacebar is also provided. It is really *three* switch contacts to allow reliable operation from the middle or either end. Enlarge the end spacebar slots slightly. Electrically, we have to provide for keys that don't

(continued on page 88)

# DIGITAL IC BREADBOARD

## Build It Yourself

*Interested in a quick and painless way to patch together an experimental or development digital circuit about as fast as you can read its schematic? This unique device described last month and concluded in this issue is a logical answer to your problem.*

by JACK CAZES

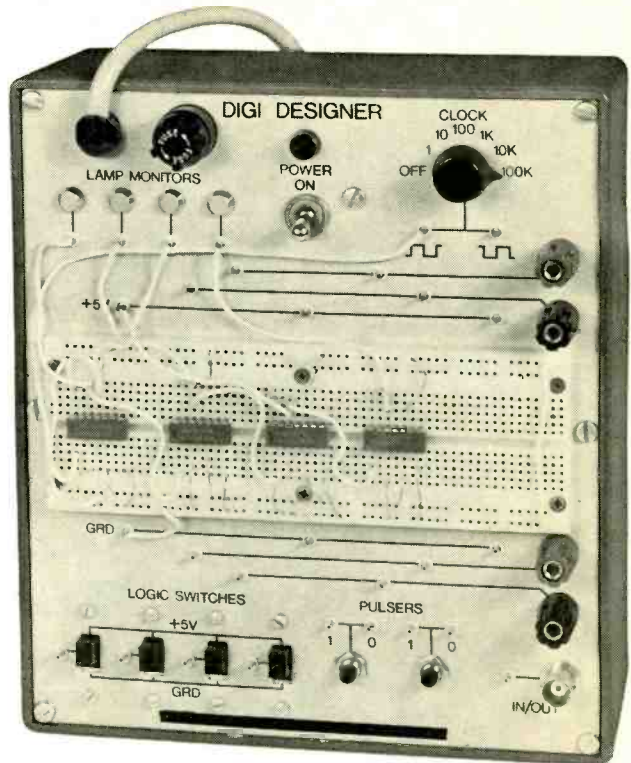

LOGICAL AND DIGITAL ELECTRONIC CIRCUITS ARE PERHAPS the least understood by most readers. But, experimenting to learn more about them can be a chore when we must find some sort of base for the circuit and then solder the test components into the circuit. This drudgery can be turned into a pleasure when you use the Digi Designer to breadboard and operate your logic circuits. All components, including diodes, IC's and transistors can be plugged in. All connections are made without soldering.

### 32-Function Arithmetic/Logic Computer Circuit—

Here's a digital computer circuit that should provide many hours of educational, as well as entertaining, experimentation. The SN74181 integrated circuit is a complete arithmetic/logic computer in a single 24-pin DIP unit. With it you can enter two 4-bit words and perform any of 32 different logic and arithmetic operations with them. The desired functions are selected by setting four FUNCTION-SELECT inputs according to the function tables given by the manufacturer. The essentials of these are reproduced below.

Plug an SN74181 IC into the Digi-Designer. Make certain it straddles the groove running up the center of the breadboard. Supply power to it by connecting pin 12 to ground and pin 24 to +5 volts. Connect pins 3, 4, 5, and 6 to the common leads of the logic switches (S5, S6, S7, and S8, respectively). These serve as the FUNCTION-SELECT inputs. The two 4-bit data inputs are made to the pins shown in the fol-

Input/Output IC Pin Connections

Binary Value	8	4	2	1
"A" Word Input	19	21	23	2
"B" Word Input	18	20	22	1
Outputs	13	11	10	9

lowing table with the resultant outputs being read at the pins indicated. Observe the output logic levels by connecting their respective IC pins to lamp monitors.

The following tables list the settings for the FUNCTION-SELECT switches (S5 thru S8) for the 32 arithmetic/logic functions:

**Arithmetic Functions**—In this mode of operation, an internal "carry" is operative and the "A" and "B" word inputs are handled on this basis. Ground IC pins 7 and 8.

Function—Select				Function
S5	S6	S7	S8	
Gnd	Gnd	Gnd	Gnd	F = A
Gnd	Gnd	Gnd	+5V	F = A + B
Gnd	Gnd	+5V	Gnd	F = A + AB
Gnd	Gnd	+5V	+5V	F = Minus 1 (as its 2's complement)
Gnd	+5V	Gnd	Gnd	F = A plus AB
Gnd	+5V	Gnd	+5V	F = [A + B] plus AB
Gnd	+5V	+5V	Gnd	F = A minus B minus 1
Gnd	+5V	+5V	+5V	F = AB minus 1
+5V	Gnd	Gnd	Gnd	F = A plus AB
+5V	Gnd	Gnd	+5V	F = A plus B
+5V	Gnd	+5V	Gnd	F = [A + B] plus AB
+5V	Gnd	+5V	+5V	F = AB minus 1
+5V	+5V	Gnd	Gnd	F = A + A (This results in each bit of binary A shifting to the next more significant position)
+5V	+5V	Gnd	+5V	F = [A + B] plus A
+5V	+5V	+5V	Gnd	F = [A + B] plus A
+5V	+5V	+5V	+5V	F = A minus 1

**Logic Functions**—In this mode of operation, the internal "Carry" is disabled; thus, each word bit is handled individually, regardless of the logic states of the other bits. Connect IC pin 8 to +5-volts.

**THE DIGI DESIGNER INCLUDES A POWER SUPPLY AND CLOCK GENERATOR** and uses them for powering and operating the logic and digital circuits you may breadboard. Bounce-less switches, lamp drivers and other circuits and operating details are in the December 1972 Issue.

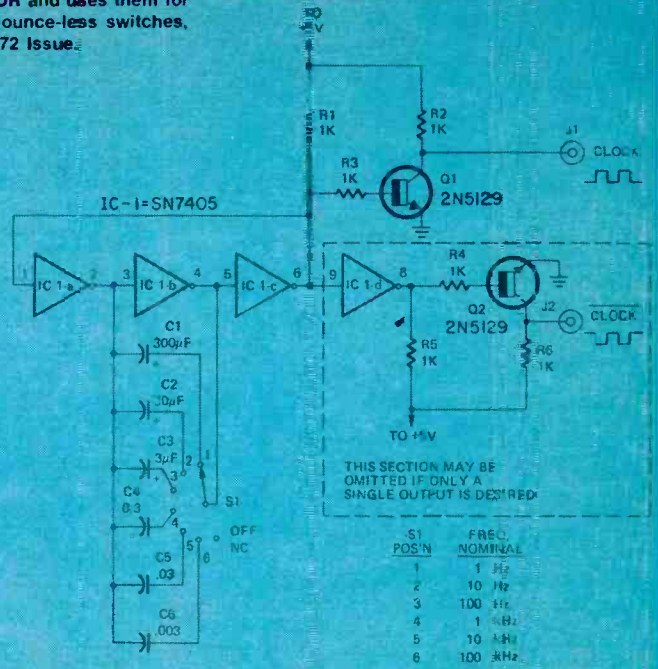
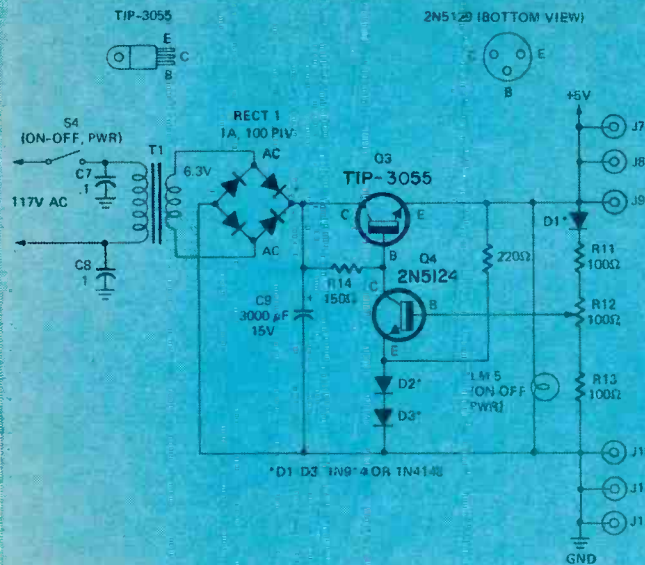

- All resistors 1/4 watt 10% unless noted  
 R1 thru R10—1000 ohms  
 R11, R13—100 ohms  
 R12—100 ohms, trimmer  
 R14—150 ohms  
 R15—220 ohms  
 R16 thru R19—22,000 ohms  
 All capacitors 15V ceramic unless noted  
 C1—300-µF electrolytic  
 C2—30-µF electrolytic  
 C3—3-µF electrolytic  
 C4—0.3 µF  
 C5—0.03 µF  
 C6—0.003 µF  
 C7, C8—0.1-µF 400V  
 C9—3000-µF electrolytic

- Q1, Q2, Q4 thru Q12—2N5129  
 Q3—TIP3055 or 2N3055  
 IC1—SN7405  
 IC2—SN7400  
 D1, D2, D3—1N914 or 1N4148  
 RECT—Full-wave bridge rectifier, 1 amp, 100 pIV  
 T1—117 Vac primary, 6.3V secondary, 1.2A (Stancor No. P6134 or equal)  
 S1—single pole, 7-position, non-shorting selector switch  
 S2, S3—spdt momentary pushbutton  
 S4—spst toggle  
 S5 thru S8—spdt toggle  
 LM1 thru LM5—5V, 50mA lamps  
 SOCKET—EL breadboarding socket SK-10  
 J1 thru J29—EL breading pins

- J30, J31, J33, J34—Five-way binding posts  
 J32—BNC panel connector  
 Misc.—PC boards, DIP sockets, case, etc.  
 A complete kit of all parts needed to build the Digi-Designer, including a case, is available for \$49.95 including postage. An SK-10 socket and 29 breading pins are available for \$24.95, postpaid. E. L. Instruments, Inc., 61 First Street, Derby, Conn. 06418.  
 Kit DES-1, consisting of the IC's needed to perform the experiments described in this article (3-SN7400, 4-SN7490, and 1-SN74181 selected for the computer circuit described is available for \$17.95, postpaid, from Electronics Co., Inc., P.O. Box 278, Cranbury, N.J. 08512.

Function-Select				Function
S5	S6	S7	S8	
Gnd	Gnd	Gnd	Gnd	$F = \bar{A}$ (Inverter)
Gnd	Gnd	Gnd	+5V	$F = A + B$ (Nor)
Gnd	Gnd	+5V	Gnd	$F = \bar{A}B$
Gnd	Gnd	+5V	+5V	$F = \text{Logical 0}$
Gnd	+5V	Gnd	Gnd	$F = \bar{A}\bar{B}$ (Nand)
Gnd	+5V	Gnd	+5V	$F = \bar{B}$ (Inverter)
Gnd	+5V	+5V	Gnd	$F = A \oplus B$ (EXCLUSIVE-OR)
Gnd	+5V	+5V	+5V	$F = \bar{A}\bar{B}$
+5V	Gnd	Gnd	Gnd	$F = \bar{A} + B$
+5V	Gnd	Gnd	+5V	$F = A \oplus B$ (EXCLUSIVE-NOR)
+5V	Gnd	+5V	Gnd	$F = B$
+5V	Gnd	+5V	+5V	$F = AB$ (And)
+5V	+5V	Gnd	Gnd	$F = \text{Logical 1}$
+5V	+5V	Gnd	+5V	$F = A + \bar{B}$
+5V	+5V	+5V	Gnd	$F = A + B$ (OR)
+5V	+5V	+5V	+5V	$F = A$

NOTE: A + B is read "A or B"  
 AB is read "A and B"  
 A is read "not A".  
 The bar over a letter or a number indicates a NOT function, so  $\bar{B}$  is read as NOT B.  
 The plus sign within a circle indicates an EXCLUSIVE OR operation.  
 Plus signs represent logical OR operation whereas arithmetic functions are spelled out.  
 These are logical expressions in Boolean algebra.

In addition to the arithmetic and logic functions shown above, the SN74181 computer circuit also provides a versatile digital comparator function. Connect IC pin 8 to ground, IC pin 16 to one of the lamp indicators, and IC pin 7 as shown in the following table:

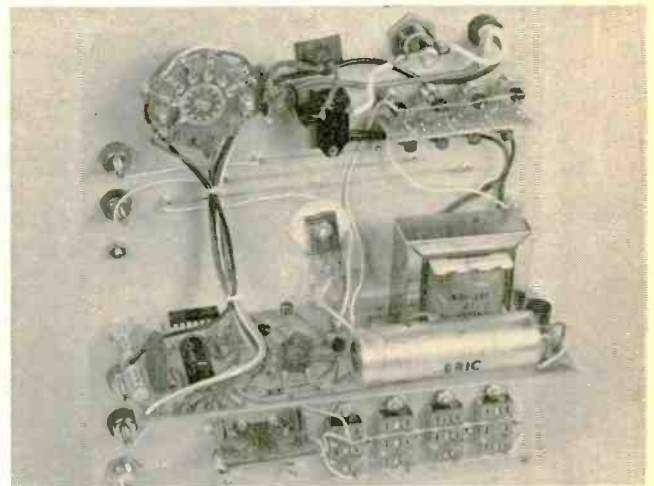

Comparator Functions						
Function-Select				IC Pin	If Lamp	This Means
S5	S6	S7	S8	No. 7	is	That
Gnd	+5V	+5V	Gnd	Gnd	On	$A \leq B$
Gnd	+5V	+5V	Gnd	+5V	On	$A < B$
Gnd	+5V	+5V	Gnd	Gnd	Off	$A > B$
Gnd	+5V	+5V	Gnd	+5V	Off	$A \geq B$

I think that these examples have shown you how you can make use of your Digi-Designer to conveniently design, assemble, and test relatively complex digital circuits, even a small computer, without soldering . . . and in only a few minutes.

R-E

# the state of

## SOLID STATE

*Of prime interest this month are a bunch of new IC's. The most exotic include a complete transmitter on a chip and a pressure transducer.*

by **LOU GARNER**  
SEMICONDUCTOR EDITOR

IF YOU'VE EVER CONSIDERED ASSEMBLING a subminiature AM transmitter, chances are you've thought in terms of a barely stable, limited performance modulated oscillator using one or two transistors. After all, a subminiature design is not compatible with the handful of components needed for a crystal-controlled oscillator, buffer amplifier, power stage, audio preamp, and modulator. *No longer!*

A new semiconductor device recently introduced by a West Coast manufacturer, Lithic Systems, Inc. (10010 Imperial Ave., P.O. Box 869, Cupertino, Calif. 95014), permits the assembly of a subminiature design with all the operational features, except for power output, of a commercial quality multistage transmitter.

Called "the world's first radio transmitter on a chip," the new device, designated the type LP2000 *Micro-transmitter*, is a monolithic IC assem-

bled in a 10-pin hermetic TO-100 package. Its functional block diagram is given in Fig. 1-a, its internal schematic in Fig. 1-b. As shown, the device comprises an oscillator, two rf buffer amplifiers, a power output stage, a combination audio preamp or code generator, a unique transformerless modulator, and a latching-type power regulator using a total of 16 transistors, 5 diodes and 9 resistors. Designed for operation on dc power supplies furnishing from 3 to 15 volts, the LP2000 is capable of supplying up to 100 mW of pulse modulated or CW rf or a 50 mW AM signal at 27 MHz. Its intended applications are in handheld, mobile, airborne and marine two-way radio equipment, as well as in R/C, biomedical monitoring, security alarm, and short-range telemetry systems.

Referring to Fig. 1-b, the LP2000's power supply regulator/latch

circuit consists of transistors Q1, Q2, Q3, Q4, Q5, Q6 and Q7, plus diodes D1, D2 and D3. Q8 is used as the oscillator and may be crystal-controlled. Q12 and Q13, together with diodes D4 and D5, make up the rf buffer amplifiers, while Q15 is the final power output stage. The audio preamp, which also can be used as a tone coding generator, consists of Q9, Q10 and Q11, with Q14 serving as the driver and Q16 as the final stage modulators.

A typical 27-MHz AM transmitter circuit, as suggested by the manufacturer for the LP2000, is illustrated in Fig. 2. According to Lithic Systems, this design can furnish 100 mW CW output, requiring 50 mA from a 12-volt supply, or 50 mW when operated as an AM transmitter, using 28 mA from its dc source. In the AM mode, it will accept up to 90% modulation with less than 10% distortion.

Available in quantity directly

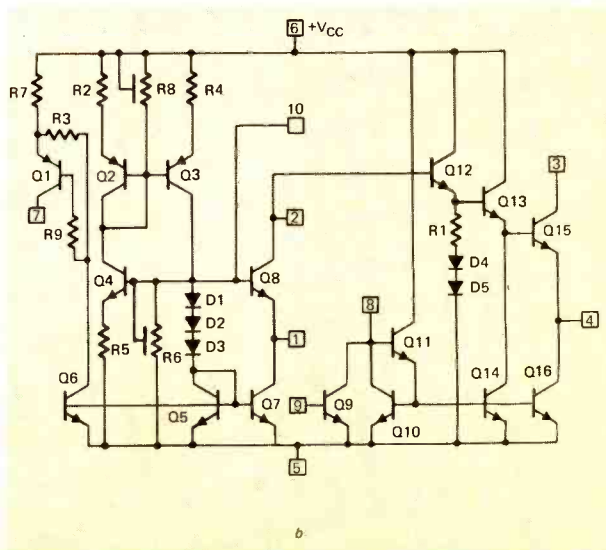
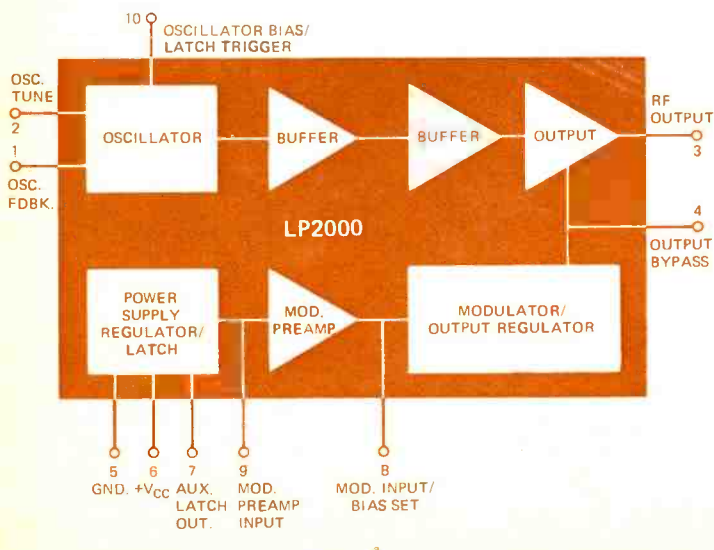

FIG. 1—FUNCTIONAL (a) AND SCHEMATIC (b) diagrams of the LP2000 microtransmitter IC.

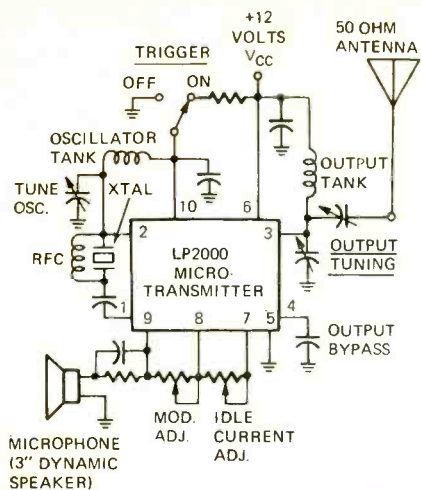

FIG. 2—SCHEMATIC OF A COMPLETE 27 MHz AM transmitter using the LP2000.

from the manufacturer, the LP2000 may be purchased in small quantities and single units from *Circuit Specialists* (P.O. Box 3047, Scottsdale, Ariz. 85257). The distributor's single unit price is \$16.00, plus postage and, if applicable, sales tax.

#### Product/device news

The National Semiconductor Corporation (2900 Semiconductor Drive, Santa Clara, Calif. 95051) has introduced a number of interesting new devices, including the world's first semiconductor absolute pressure transducer, a dual audio amplifier IC, and a complete digital clock circuit on a single monolithic chip.

Intended for a wide range of applications in fuel metering and ignition controls, heating, refrigeration, automotive safety and diagnostic controls, utility metering and fluid or pneumatic systems proportional controls, the new pressure transducer, designated type LX1600A, contains four functional transduction elements in a single hybrid IC package—diaphragm-vacuum reference, a piezoelectric sensor, a signal discriminator-conditioner, and a signal amplifier-processor. The first three elements are contained in one silicon die, while the fourth is provided by a standard linear operational amplifier. Illustrated in Fig. 3, the LX1600A is supplied with a calibrated range between 0 and 15 psi, but can be used up to 27 psi. In operation, the device is equivalent to a simple potentiometer without loading problems, having an input impedance in the thousands of ohms and an output impedance measured in megohms, thus providing protection for both input overvoltage and output short circuits. The device's maximum output is 5 mA, its maximum excitation voltage 30 Vdc.

National's new dual audio amplifier, type LM377, can provide up to 2 watts of continuous rms power into 8-

ohm loads on each of its two channels while providing complete short-circuit protection and thermal limiting. It has an input impedance in excess of 10 megohms, making it ideal for use with ceramic phono cartridges. Assembled in an 8-pin dual-in-line batwing heat sink package, the LM377 can provide 100 dB gain with a maximum distortion of only 0.5% at 1 kHz. It is designed for operation on an 18-volt dc source and has an internal power supply regulator.

Identified as the MM5314 series, National's new digital clock IC's contain all of the counting, decoding and multiplexing circuitry required for 4- or 6-digit electronic clocks. Intended for operation on a single 11 to 19-volt supply and a half-wave rectified 50 or 60 Hz input, the new devices are de-

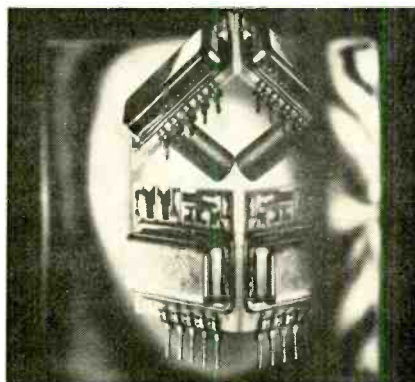

FIG. 3—NATIONAL SEMICONDUCTOR'S LX1600A absolute pressure transducer IC.



FIG. 4—TI'S NEW SN54/74284 AND SN54/74285 digital ICs.

signed to work with inexpensive plastic transistors for digit and segment driving of standard LED's or incandescent displays.

Two new TTL/LSI IC's from Texas Instruments, Inc. (P.O. Box 5012, Dallas, Tex. 75222) can be used together to generate an eight-bit binary product in only 40 nanoseconds. Designated types SN54/74284 and SN54/74285, these 4-bit-by-4-bit parallel binary multipliers each contain the equivalent of over 200 gates on a monolithic chip. Illustrated in Fig. 4, the new units are fully TTL/DTL compatible. The devices are offered in 16-pin plastic and ceramic DIP's as well as in ceramic flat packs.

Motorola Semiconductor Products, Inc. (P.O. Box 20912, Phoenix, Ariz. 85036) has introduced four new high-threshold logic (or HTL) IC's intended for use in demanding commercial and industrial applications, such as machine tool and process controllers, computer peripherals, appliances, measuring and dispensing equipment, and so on. The new devices include the MC686, a 4-bit shift register, the MC684, a decade counter, the MC685, a binary counter, and the MC688, a dual J-K flip-flop. With a typical switching threshold of 7.5 volts and a dc noise margin of (typically) 6 volts, all four units are designed for operation on a 15-volt dc source. Shown in Fig. 5, each of the four new HTL devices is available in either



FIG. 5—HTL DEVICES RECENTLY INTRODUCED by Motorola.

black plastic or ceramic DIP's. Depending on type, unit prices range from \$2.55 to \$6.30.

A new high-voltage display-driver IC is now available from Precision Monolithics, Inc. (1500 Space Park Drive, Santa Clara, Calif. 95050). Exhibiting the highest breakdown voltages yet attained by a conventional linear processing technique, the new device, Fig. 6, is designed to drive the



FIG. 6—MONO DRV-01 HIGH VOLTAGE DISPLAY DRIVER now available from Precision Monolithics, Inc.

cathode segments of high-voltage gas discharge displays, such as the Burroughs Panaplex® and Sperry numerical display devices used in miniature calculators and electronic test instruments. Identified as the monoDRV-01, the new unit is compatible with MOS logic and has a guaranteed breakdown of 145 volts (160 volts typical), compared to the previous industry maximum in the 80 volt area.

R-E

## step-by-step

# TV TROUBLE

*Proper agc action is a prerequisite for a television picture with optimum brightness and contrast. Here is how the all-*

by ART MARGOLIS

AS MENTIONED IN AN EARLIER ARTICLE concerning the agc keyer, (*Radio-Electronics*, September, 1972) there are two more agc stages, the agc amplifier and the agc delay. This month we'll discuss the agc amplifier. The delay will be covered in a future article.

Why have the amplifier and the delay? Why not just use the varying dc control voltage that comes out of the agc keyer and apply it directly to the rf and i.f. amplifiers to keep total gain constant?

It's because agc has to always be applied to the i.f. stages but only sometimes applied to the rf stage. The rf amplifier output is critical. To maintain a snow-free picture, it must be strong. That way it produces a high rf-mixer noise ratio. Such a high ratio overrides mixer noise and a snow-free display is assured.

Therefore the following agc action is desired. On strong signals agc should be applied to both rf and i.f. During medium strength signals agc should be applied to the i.f. but not the rf. When a weak signal is received no agc should be applied to the rf and little or none to the i.f.'s.

The agc amplifier takes the keyer's dc output and analyses it. During strong signals the amplifier sends plenty of signal to the delay and the i.f.'s. The delay turns on and sends a control voltage to the rf.

When medium signals are received, the amplifier sends enough voltage to the i.f.'s for control but not enough to the delay. The delay does not turn on and lets the rf amplifier run wide open.

When weak signals are received, the amplifier produces little or no output and neither the rf or i.f. are controlled. They both run at maximum gain.

### Typical transistor agc amplifier

The agc amplifier receives a filtered dc control voltage from the negative end of the 8- $\mu$ F filter in the

keyer collector circuit. The dc that is varying slightly as a result of the height of the horizontal sync pulse in the video, is applied to the base of the agc amplifier from a voltage divider consisting of a 5000- and 33,000-ohm resistor.

The agc amplifier is forward biased by voltage from the plus 12V source. The voltage is developed as current flows from the base to the emitter and through the 470-ohm emitter resistor to the 12V source. The base is driven from the keyer through R1. Resistor R2 isolates the base from the emitter.

The dc voltage from the keyer varies with signal strength. As signal strength rises, the forward bias on the agc amplifier increases. As a result, collector current increase makes the collector more positive in voltage. A higher positive voltage is applied to the i.f. amplifiers and the delay. This tends to make them have a strong agc control.

As signal strength drops the amplifier forward bias decreases. This makes the collector less positive in voltage. Therefore less plus voltage is applied to the i.f. amplifiers and delay. This tends to reduce the agc control.

The agc delay won't turn on unless the amount of plus voltage is relatively high. The i.f.'s are controlled even though the agc amplifier voltage is not positive enough to turn on the delay.

Typically the emitter voltage is around 10V. The base is about 9.3. This gives the pnp transistor a forward bias of around 0.7V. When this bias is present the collector ends up with about 5V. This is obtained from the 12V supply through resistors R6 and R7 in series.

### Agc amplifier troubleshooting

The agc amplifier circuit consists of all components clustered around its input and output. It does not include the i.f.'s, delay or keyer.

The technician arrives at the agc

amplifier and considers it a trouble suspect when agc trouble is occurring and the keyer has been exonerated. Strong local channels are coming in overloaded, or not at all, while the weak distant channels are being displayed fine. Sometimes the weak channels are blanked out.

The technician has been to the first test point, TP1, the negative end of the 8- $\mu$ F filter capacitor. Two dc readings were taken there. One with a strong channel tuned in and the other with the channel selector cocked between two channels. The on channel reading was between 5 and 7 volts while the off channel reading was 12 volts. The keyer is cleared of trouble.

The next test point is TP2, the junction between the 15,000-ohm and

TYPICAL AGC AMPLIFIER CIRCUIT

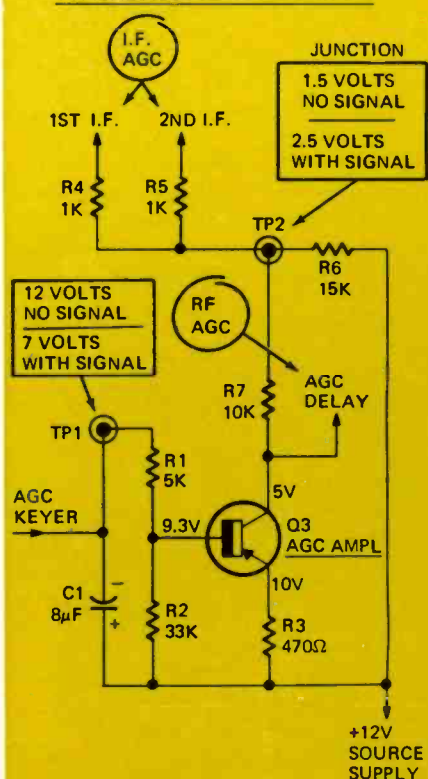

AN AGC AMPLIFIER is used almost universally in solid-state TV sets. Its purpose is to amplify and invert—when necessary—the varying dc voltage developed by the agc keyer.



# SHOOTER'S GUIDE

that is snow-free with good horizontal and vertical sync along important agc amplifier works in solid-state TV sets.

10,000-ohm age amplifier collector resistors. The strong channel and off channel readings are made. One of three things is noted. The vtvm shows normal readings, there's a constant low voltage or a constant higher voltage. The trouble chart shows the three pathways. You have arrived at a diagnosis except if a constant higher voltage is read, then there is excessive agc control and you go to its next step.

One side of the 10,000-ohm resistor is unsoldered and a dc voltage reading made at the junction.

The voltage will be near source or around a volt or two. If it is near 12V source, then the video i.f. stages are at fault. If the voltage is low the age amplifier and delay become the suspects.

The next step is to resolder the

resistor back in the circuit and carefully disconnect the emitter of the age delay. Then read the test point once again. If the test-point voltage remains the same now, the trouble is in the delay circuit. However, if the test-point voltage rises high, then the age amplifier is the guilty party.

Once the age amplifier circuit becomes the known guilty party, the end of the job is to locate and replace the bad part.

The age amplifier is the pnp transistor with 15,000-ohm and 10,000-ohm collector resistors, 470-ohm emitter resistor and the 33,000-ohm base resistor. The 5000-ohm resistor is also involved, but it is really part of the keyer collector leg.

The test points now become the

base, emitter and collector. Voltage tests are next, with the collector first in line.

A reading is made and the collector, when not normal, is either high or low in voltage. Since current flows from the i.f. amplifier bases and the delay emitter to the amplifier collector, they must pass through the 10,000-ohm resistor on their way. The 15,000-ohm resistor is an isolation resistor between the amplifier collector and positive 12-volt source. Note the emitter is at +10 volts.

**Collector high**—If the collector is high then the 15,000-ohm resistor becomes the prime suspect. It could have shorted.

Another possibility is that Q3 is conducting too heavily drawing more

**BLOCK DIAGRAM  
AGC ACTIVITY**

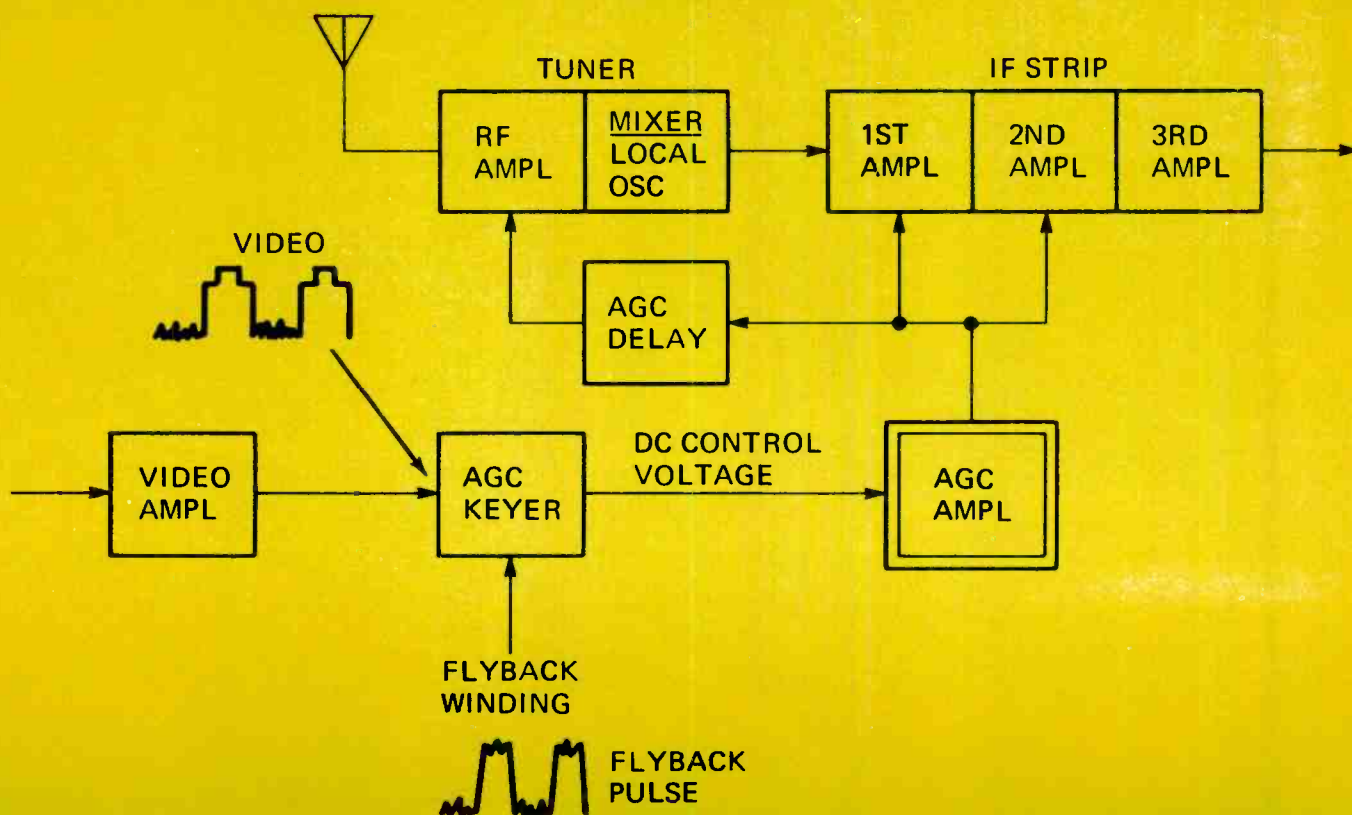

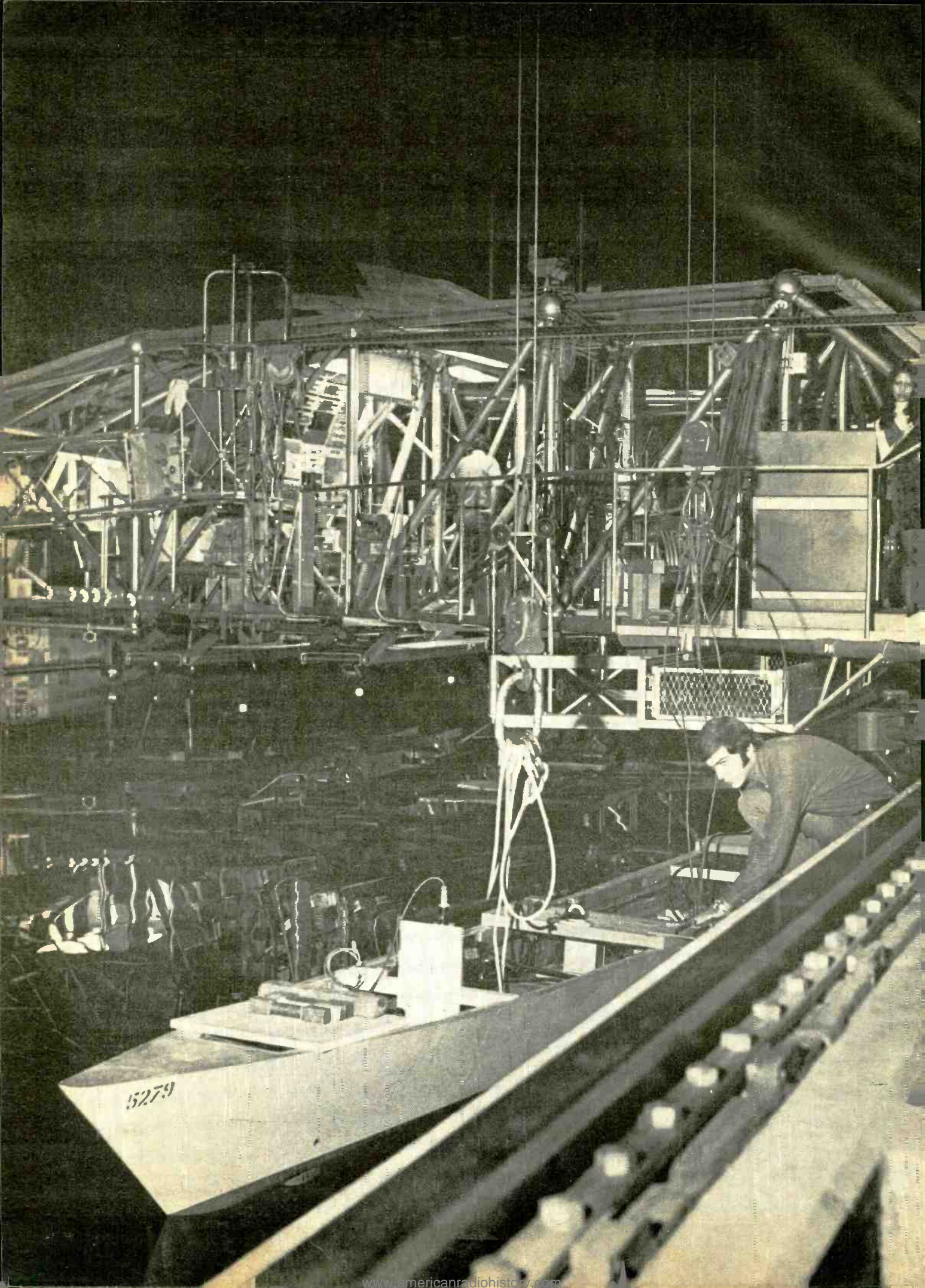

# If you're looking for a career instead of a job in electronics...

It costs millions of dollars to build modern ocean going vessels. The final design of such ships is based on extensive testing with sophisticated electronic measuring equipment using exact models as shown in the photo of the Naval Research and Development Center. The engineering technicians who check out, maintain and repair such equipment have to be experts. Their work is not only interesting and exciting, they also enjoy top pay in their field.

CREI offers Electronic Engineering Technology programs through home study. You have a choice of *eighteen* different program arrangements so you can specialize in exactly the area of electronics you want. All of the programs, except a brief introductory course, are college-level.

If you want to qualify for the highest paying level of technical employment in electronics, we invite you to consider the unique home study programs of CREI. Here is a list of just some of the CREI programs: *Communications Engineering • Computer Engineering • Missile & Spacecraft Guidance • Radar & Sonar • Television Engineering • Nuclear Instrumentation & Control • Digital Communications • Industrial Electronics • Electronic Systems Engineering • Microwave Communications • Satellite Communications • Cable Television Engineering*

For over 45 years, CREI programs have been recognized by leading technical organizations as effective home study training in advanced electronics.

**Qualifications to Enroll.** To qualify for enrollment in a CREI program, you must be a high school graduate (or equivalent). You should also be working in electronics or have previous training in this field.

**Send for FREE book.** If you are qualified, send for CREI's newly published book describing your career opportunities in advanced electronics. This full color book is filled with facts about career opportunities for you.

**Capitol Radio Engineering Institute**  
A Division of McGraw-Hill Continuing Education Co.  
3939 Wisconsin Avenue, Washington, D. C. 20016



Accredited Member, National Home Study Council

CREI, Dept. E1402D  
3939 Wisconsin Avenue  
Washington, D. C. 20016

Rush me your FREE book describing my opportunities in advanced electronics. I am a high school graduate.

Name \_\_\_\_\_ Age \_\_\_\_\_

Address \_\_\_\_\_

City \_\_\_\_\_ State \_\_\_\_\_ ZIP \_\_\_\_\_

If you have previous training in electronics, check here

Employed by \_\_\_\_\_

Type of Present Work \_\_\_\_\_

Veterans and servicemen, check here for G. I. Bill information

**CREI**  
**CAPITOL**  
**RADIO**  
**ENGINEERING**  
**INSTITUTE**  
WASHINGTON, D.C.

SYMPTOM - STRONG CHANNELS DEFECTIVE, WEAK CHANNELS NORMAL (SOMETIMES BLANKED OUT)

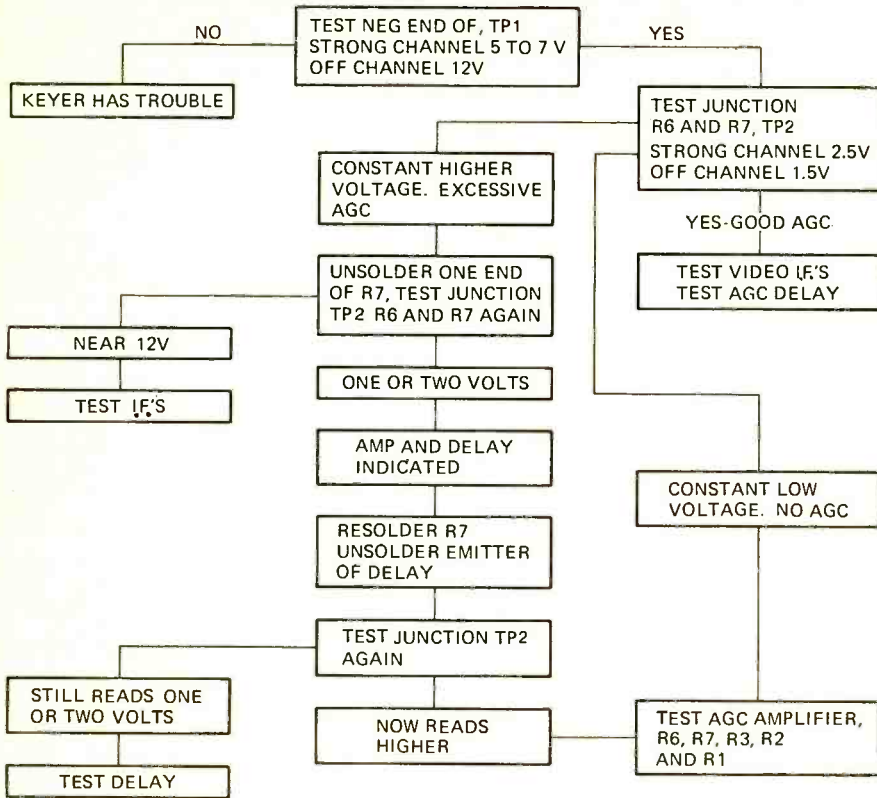

AGC AMPL

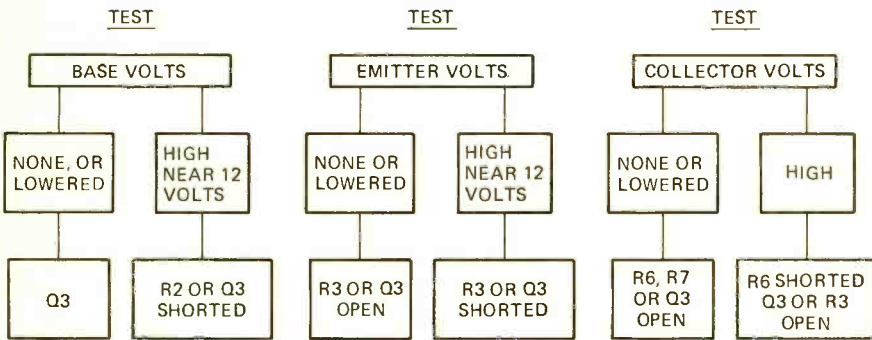

TWO TROUBLESHOOTING CHARTS help locate and repair the trouble speedily and efficiently. The top one localizes the trouble and the bottom one helps to find the defective component.

electrons from the i.f.'s and delay. This increases the positive voltage on the collector.

Q3 can conduct too heavily if it is leaky or shorted, or the 470-ohm emitter resistor becomes shorted.

**Collector low**—When the collector is low, then the flow of current from the i.f.'s and delay has lessened. The collector becomes more negative, or less positive.

This can happen if the conduction of the transistor is lessened or turned off. If the 15,000-ohm resistor opens then the i.f.'s lose their base forward bias and the delay loses its emitter or forward bias. The i.f.'s and delay turn off. The amplifier collector loses its positive voltage and the amplifier turns off.

When the transistor or resistor R6 or resistor R7 opens, the collector

voltage will drop all the way to zero.

**Emitter**—The emitter has one component attached. If the 470-ohm resistor opens the emitter loses its 10 volt potential. Should the 470-ohm resistor short, plus 12 volts will appear



THE PICTURE BENDS—NOT ENOUGH AGC. Video is too strong and beginning to overload.

on the emitter. The shorting, leaking or opening up of the transistor can make the emitter voltage disappear, drop or rise to plus 12-volt source.

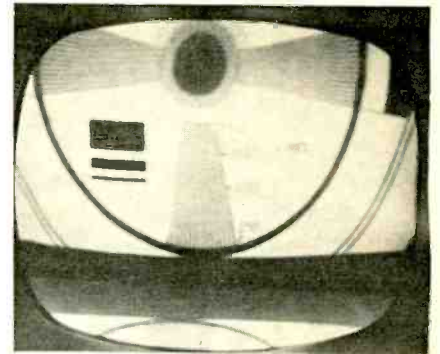

OVERLOADED—NO AGC VOLTAGE. Picture is out of sync and shows signs of overload.



WASHED OUT—TOO MUCH AGC VOLTAGE. RI and i.f. amplifiers are tending to cut off.

**Base**—The base voltage is tied in with the keyer collector circuit. Since the keyer has been exonerated, the base circuit is practically given a clean bill of health too. The 33,000-ohm resistor could possibly cause the base voltage to rise, if it shorts.

Usually though an incorrect base voltage in this case could only happen if either the emitter-base or base-collector junction shorts. Then the voltage could change.

R-E



"What do you mean, your set fixed itself?"

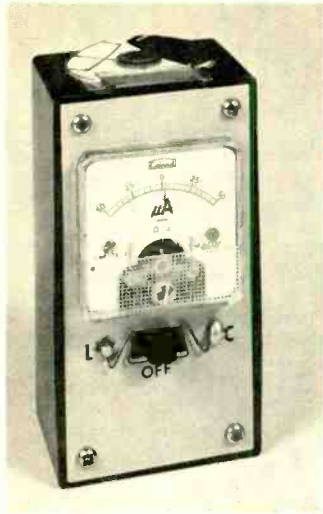

# two-in-one light meter

*This instrument combines an ordinary light meter with a color-temperature bridge. It will give you both the quality and intensity of your light*

by HAROLD PALLATZ



THIS UNIT COMBINES A SIMPLIFIED color-temperature bridge<sup>1</sup> with a light-intensity meter. Simply flip the switch to convert from one to the other. Three convenient light-intensity ranges permit making measurements from the weakest to very high intensity illumination. Total construction cost is just over \$10.00.

A little additional experimenting resulted in a truly "starved circuit," reducing the number of components to the minimum: a single resistor, a pair of cadmium sulfide (CdS) cells (98¢ pair), a meter and two penlight cells. In spite of the lack of complex parts, the accuracy will compare favorably with expensive laboratory type instruments.

## Circuit theory

The color temperature meter, uses two filters, a red and a blue. Place one over each CdS cell. These form a bridge circuit (Fig. 1). The other two arms of the bridge are the penlight batteries. Under balanced conditions (where the amount of red light is equal to the amount of blue light), the zero-center microammeter will read center (or zero). Should there be more red than blue light, the meter will deflect to the left according to the amount of unbalance. Thus readings made under tungsten lamps will differ from readings

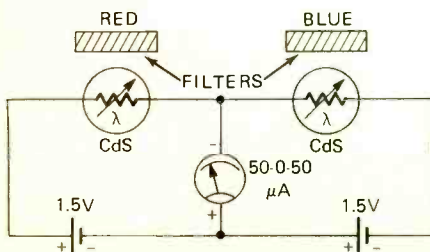

FIG. 1—COLOR TEMPERATURE METER is a bridge that balances red and blue light.

made under sunlight or fluorescent lights. Since batteries make up the other two arms, and their impedance is low, bridge sensitivity is maximum. While I

## MATERIALS LIST

Meter, 50-0-50 microamperes. Calrad CMO 38-3 Case, 4" x 2 1/4" x 1 1/2". Olson Radio CA 356 \$1.09

Photocells (2), cadmium sulfide. Resistance range 200 ohms to 1 meg, sensitivity 500-600 Angstroms, 150 Vdc max, 150 mW. Olson Radio TR-091 98¢ pair

Switch, slide type, dpdt with center OFF position. Calrad SS-7

Penlight cells (2), leakproof type. Size AA Resistor, calibrating (approx) 18,000 ohms, 1/2 watt

Red filter\* Note: these filters can be made with transparent dial light dip paint.

Blue filter\*

Parts may be purchased at Olson Electronics 260 S. Forge Street, Akron, OH 44327, Radio Shack Corporation, 730 Commonwealth Ave., Boston, Mass. 02215, and Lafayette Radio, 111 Jericho Toke., Syosset, L.I., NY 11791

\*Filters are also available from Edmund Scientific Company, Barrington, NJ 08007

For red use Edmund No. 82,015 (Medium Red). For blue use Edmund No. 82,033 (Light Blue). They come in sheets 20 x 24 inches and are \$2.50 each. Also available from Edmund is a small Color Filter Sample Book. This has all their colors (size 1 x 4) and costs \$1.50. (use No. 40,675 for ordering the book).

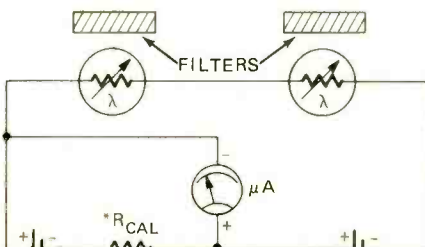

\*ADJUST VALUE OF  $R_{CAL}$  (APPROX. 18K) TO READ EXACTLY FULL SCALE (AT FULL LEFT) WITH ZERO LIGHT ILLUMINATION ON Cd CELLS.

FIG. 2—LIGHT INTENSITY is measured by one cell; the other supplies a bucking voltage.

made no attempt to do so, it is possible to calibrate your meter dial directly in degrees K (Kelvin).

The light intensity meter is conventional. The two CdS cells are in series with the meter and a single battery. The second battery (Fig. 2) is connected in reverse through a calibrating resistor to bias the meter from its normally zero center position to full left scale deflection with zero light intensity. Thus the full meter swing can be realized. The circuit serves a second function, that of a battery check. The batteries should be changed when full left deflection is off by more than one division. Under normal conditions, you should realize almost as normal shelf life (one year) of the batteries.

The basic range of our instrument was found to be 8 foot-candles (at full scale). A white cardboard disk (Fig. 3)

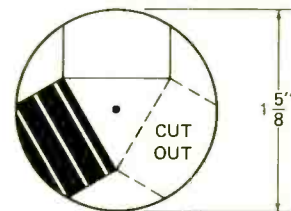

FIG. 3—RANGE EXTENDER, three shields that let the filters get more or less light.

was cut out to increase the light range 10 times (0 to 80 foot-candles). I used the cardboard wrapper of CONTACT Cold Capsules. It is also possible to use a piece of metal with small holes pierced in it. For the HIGH range (0 to 800 foot-candles), I drew India ink stripes on a sector of the disk. The first results with the ink showed that too much light still passed through the cardboard, so some black plastic tape was added. This did the trick.

## Construction

Use template (Fig. 4) for the panel layout. A battery clip cannot be used because the Olson meter case is a squeeze fit. Solder the wires directly to the battery terminals. Solder fast, using a minimum of heat, or battery life may be reduced. The meter hole required proved to be 1/32-inch larger than a standard 1/2-inch socket punch. Use a half-round file and apply muscle! The slide switch (must be of the center OFF type dpdt), requires a 1/4 x 1/2-inch rectangular hole. Drill quarter-inch holes

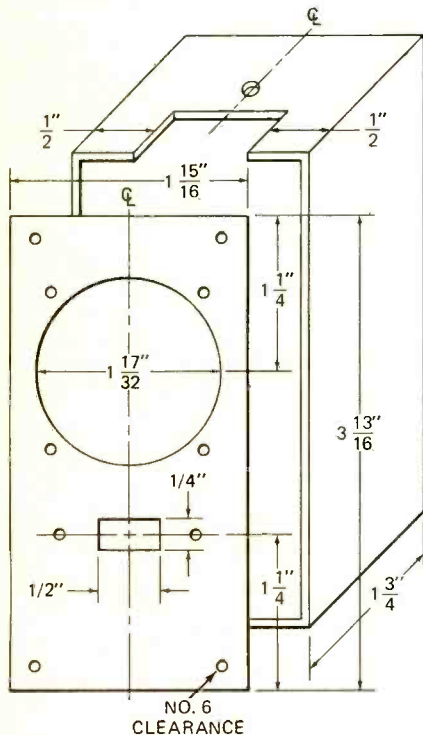

FIG. 4—TEMPLATE FOR METER PANEL.

and file to shape. After all work is completed on the panel, go over its surface with fine steel wool to remove nicks and scratches and provide "tooth" for the paint. We used Dove Grey (Krylon 1605) spray enamel to finish the panel. Use press-on decals for the lettering.

The red and blue filters may be made of sheet cellophane, or purchased glass filters may be used. You can also use transparent paint (such as General Cements Dial Light Color Kit 66-6). I suggest that rather than coat the face of the CdS cell directly (it might craze the plastic shell), use transparent tape and coat that instead. Both the red and blue should transmit light approximately equally. You can check the light transmission by switching your meter to L and placing a filter in front of both cells. Then try the other color. Readings should fall within one meter division. The photocells were set in the top of the case, near the front, close enough together so that they would be covered by any section of the light extender.

Fig. 5 is the complete circuit dia-

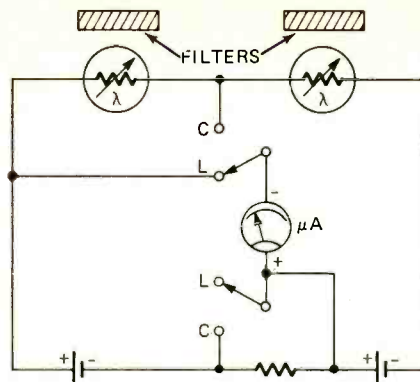

FIG. 5—COMBINED CIRCUIT, with a dpdt switch. Center position of the switch is OFF.

gram. Always use fresh new batteries. Our battery is held down with a piece of stiff wire (taped to the batteries) and wrapped around the slide switch mounting screws. Transparent tape is used to hold the CdS cells in place, the tape holding the cells to the meter mounting screws.

## Calibration

The color balance meter may be

### Color-temperature chart of common light sources

Color Temp (Kelvin)	Source
1900	Plumbers candle
2760	40-watt tungsten lamp
2865	100-watt tungsten lamp
3200	G-E Mazda 3,200K lamp
3400	Photoflood lamp
3000	Warm white fluorescent
4500	Cool white fluorescent
6500	Daylight fluorescent
5400	Noonday sun
6500	Overcast sky

calibrated directly in degrees K (Kelvin) by using the table. Where maximum precision is desired, make this calibration at some constant level of illumination (such as 4 C.P. or half scale on the meter), by sliding the switch to the L setting. Then return to the C setting for the color calibration. Noonday sunlight is 5,400° K. An overcast sky runs 6,500° K. A photoflood lamp is 3,400° K, a 100-watt tungsten lamp 2,865° K. Where a particular color temperature falls on your meter dial will be primarily related to the red and blue filter you have used. Thus every instrument will read somewhat different. Once calibrated, the repeatability will be good and reference chart can be made up and pasted on the bottom of the meter case. If you wish, it would be possible to calibrate the meter dial directly. This is not advised—you must be very careful when removing the protecting meter cover—the slightest dust or iron filing will impair meter operation. The color balance readings will hold true for a wide range of light intensity levels. Near zero illu-

mination levels, do not expect consistent color temperature results.<sup>2,4</sup>

The L light intensity range is most easily calibrated by direct comparison with another light meter. Your local photographic store may let you compare your meter with theirs. Our meter turned out to have a basic 0-8 foot-candle range. Your range will depend upon the CdS cells used, their placement inside the case and a number of other factors such as case opening size, meter sensitivity, battery voltage. You can use the table for a cross-check of illumination light values<sup>2,5</sup>. The light intensity values can be made into a reference chart or marked directly on the meter face.

## Applications

In color photography, it is very important to know the color temperature of the light source if perfect color pictures are to be made. This may be easy when photographing under a noonday sun, but what is the temperature at early morning or at sunset? Your meter will give an instant answer. Also when sunlight is mixed with fluorescent or tungsten light the color balance of the light must be measured accurately if the best results are to be achieved. You can also test out the color value of photographic filters by inserting the filter in front of the meter and noting the readings. You can also check your 3,200° K color photography lamps to see how close they are to new condition.

The photographic applications for the intensity function will be numerous<sup>2,5</sup>. You can use it for enlarging by placing the meter directly on the easel and adjusting the diaphragm for some known reading. A constant meter reading will mean a constant exposure time. Twice the light reading means that the exposure should be cut in half. You can also use the meter for picture taking<sup>3</sup>, but a discussion of the various exposure times, *f* stops and film speed relationships are beyond the scope of this article. It is possible to purchase a small exposure-guide calculator in most photo shops and convert your meter readings directly to exposure values by using them together. R-E

## References

1. Zworykin and Ramberg, *Photoelectricity and Its Applications*, 272, bridge circuit for determining color temperature of a lamp.
2. *Ibid*, page 19. Temperature and brightness table.
3. *Ibid*, pages 292-293, measurement of photographic exposure.
4. Clark, Walter, *Photography by Infrared*, John Wiley & Sons. Page 139, color temperature table.
5. Barrows, *Light, Photometry and Illumination*, McGraw Hill Co. (1912). Page 38, brightness of light sources table.

# R-E's Service Clinic

## Intermittents—how to locate them

*A little heat, a little cold—fine intermittent locator*

by JACK DARR  
SERVICE EDITOR

LET'S HAVE A FEW WORDS ABOUT INTERMITTENTS. Not the words normally used around the shop; this magazine must go through the mails. First, let's look at a few facts about these infuriating things.

An intermittent is just that; something which makes intermittent *contact* in a circuit. It can be a short, but most of the tougher ones seem to be opens. They can be broken down into two general types—the “physical” or jar-intermittent, where you can make it act up by tapping the chassis; and the thermal, caused by heat.

The “jar” intermittents are much easier to find. By tapping the chassis very carefully you can find the most “sensitive” area, and from this point, it's not too hard to locate a guilty part or solder joint. The eraser of a lead-pencil makes a dandy tapper.

Thermals are tougher. Even in a transistor chassis, you're going to find thermal intermittents. This is especially true of those “long-term” intermittents that cut out once a day. Something in there is getting hot and expanding. The circuit opens (or shorts to other parts) and there you are. In the standard thermal no amount of jarring the chassis (or kicking the cabinet) will faze it.

There are a couple of tricks you can play on these. One is running the set with the ac line voltage just a little above normal. This won't hurt anything unless you leave it on for too long. The high line voltage will raise the dc voltages. It will also raise the temperature of things and make the intermittent more apt to act up. If this doesn't work, try running it with line voltage a little below normal. This leaves things a little cooler than they usually are.

Determine the characteristics of the trouble. Does it cut out once a day, every 2-3 days, every hour or so, etc. Questioning the owner is a very good way to get this information. If this is a long-term intermittent, and irregular, the chances are that it is a thermal.

There's a division here. If the intermittent shows up within a short time after the set's turned on, say 5 to 10 minutes, the chances are that it is in some part which generates its own heat; a current-carrying resistor and so on. Solder joints are frequent offenders in this category.

The other and much more difficult type, is the long-term intermittent. These show up at irregular intervals, from hours to days. They're also thermal, but are caused by “conducted” heat, from other parts on the chassis getting hot. This heat is conducted through the chassis, or the air. In “touchy” intermittents, the frequency of cut-out often depends greatly on the ambient temperature. (We'll show you a real wowser like this in a moment!)

In both types, heat is the trouble-maker. It causes physical movement of the part, making or breaking contact. This can be as little as a thousandth of an inch, if it's inside a resistor, coil, or capacitor, but it's enough! Printed-circuit board solder joints are frequent offenders. A “pocket joint” (see diagram) can make perfect contact. But if

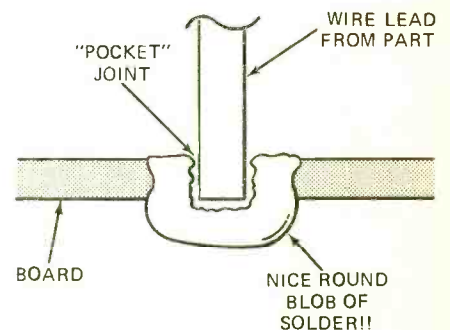

the board expands slightly, whammo. If you suspect this, you can “get out the shotgun”; remelt and resolder *all* solder-joints in the area of the trouble. You may never know which one it was, but you'll fix it.

### Isolation

The first thing you must do is isolate the area of trouble. From the

This column is for your service problems—TV, radio, audio or general and industrial electronics. We answer all questions individually by mail, free of charge, and the more interesting ones will be printed here.

If you're really stuck, write us. We'll do our best to help you. Don't forget to enclose a stamped, self-addressed envelope. Write: Service Editor, Radio-Electronics, 200 Park Ave. South, New York 10003.

characteristics, you know *about* where it is; that is, signal circuits, sync, sweep. Observing the characteristics will give you clues. Now, check every part of the circuit that could affect that particular function.

Now, see if you can make it show up. To do this, you can either apply more heat, or less heat—cool it. The reaction to these tests will give you a lot of data and that's what you need. You can apply heat with a heat-lamp, or by touching the suspected part with the tip of a soldering iron, or by blowing hot air on it with a heat-gun or old hair-drier. Cooling is much eas-

ier. The spray-can coolant is a very useful weapon for locating intermittents.

Here's a good example. I had a Zenith color TV set on the bench. The picture flickered on and off at highly irregular intervals, leaving a white screen. This was a very fast flicker, sometimes repeated three or four times. After doing this, it would play for a couple of hours. In fact, it sat on the bench under observation for two days; no flicker! Fortunately for my production ratio, I was working on other things at the same time!

Then I got after it in earnest.

Turning it on, I waited. This time, it started to flicker in only about 20 minutes. A quick check with the scope and a crystal-detector probe showed a steady signal at the i.f. input, and a severe flicker at the video detector output. So, I had it pinned down; it was in the i.f. (Clamping acc made no difference.)

Now I made thermal tests. With a junk hair-drier which still worked, I blew hot air on the i.f. stages. On the first and second stages, no result. As soon as I hit the last i.f. stage and detector, wham! It started flickering like mad. To verify this, I blew spray coolant on it. The picture came back as steady as a rock. Now I had it.

The i.f. stage in these sets can be taken out in toto, by pulling off some push-on connectors and taking out three screws. Making up a set of connecting leads, I put it on the bench and turned it on. Despite a tendency to oscillate, it worked well enough for testing. I checked each part in the output stage, by touching it with the tip of a soldering iron. When I hit the output transistor, out it went!

Verifying this, I sprayed the thing with coolant. It came back on. Replacing this transistor cleared up the trouble. Hooking the original transistor to a curve tracer, it checked perfectly. Heating it with the soldering iron, in about 20 seconds it went to the horizontal line; it was opening up internally! Spraying it with the coolant brought it back again. I could repeat this as often as I wanted to. For a definite check, I warmed up my replacement transistor with the soldering iron. Absolutely no change in the picture.

About this time, someone will say "But you'll ruin those delicate transistors, heating them up like that with a soldering iron." To which I can reply. "Possibly so. However, I have never damaged one yet with this method, and I've *tried!*"

I will admit that I've been guilty of saying that there was no such thing as an intermittent transistor. I stopped this; people kept sending me intermittent transistors, and I kept finding them in sets I was working on.

They *can* be thermal. In fact, a post-mortem analysis of the case of the Zenith brought out an interesting fact. The reason it sat on the bench and played for two days was that during those days the shop *air-conditioner* was running, and blowing right at it! On the day that it started cutting out, the air conditioner was turned off! This comparatively small difference in the ambient temperature was enough to make it start acting up.

There are many ways you can go after this kind of trouble; don't ne-  
(continued on page 78)



## Perma-Power Color Brite

### When the picture looks good, you look good.

When a color TV picture fades, or when the black-and-white is erased by a cathode-to-filament short, you can save the day, and the tube, by installing a Perma-Power Britener.

*Boost* models bring out lost sharpness and detail by providing increased filament voltage to increase electron emission. Full contrast and color quality return immediately.

*Isolation* models restore the black-and-white information that gives a color picture its quality, by isolating the short, thus restoring black-and-white video drive.

Short now . . . fade later? Handle

both jobs with a Color-Brite *Combination Isolation and Boost Britener*.

There are Perma-Power Color Brite models for both round tubes and rectangular tubes. In fact, Perma-Power has a Britener for just about every picture tube ever made! You'll look very good to your customer when you prolong the life of the expensive picture tube. Pick up a supply of Color-Brites from your Perma-Power distributor!



PERMA-POWER DIVISION  
CHAMBERLAIN MANUFACTURING CORPORATION  
5740 North Tripp, Chicago, Illinois 60646

Circle 20 on reader service card



# Up-to-the-minute service information\* from Sams

\*Selected portions of manufacturers' servicing data bound in convenient book format

## Transistor Radio Servicing Data

Designed for the service technician, Sams Transistor Radio volumes are published monthly. Each volume in the series contains schematics, parts lists, pictorial presentations, troubleshooting data, plus other information on up to 17 of the latest transistor radio receivers and other youth products. Includes data you need to service virtually any receiver mass-marketed in the U.S.A. The Photofact® Annual Index lists the equipment covered in each volume.

\$3.25 each.

## Modular Hi-Fi/Stereo Servicing Data

What the transistor radio series does for transistors, this series does for hi-fi and stereo components and compacts. Issued monthly, each volume includes schematics, pictorial presentations, pertinent servicing data and parts lists for up to 13 of the latest modular components — tuners, receivers, amplifiers, etc. Covers virtually all equipment mass-marketed in the U.S.A.

\$3.95 each.

## Scanner-Monitor Servicing Data

Contains comprehensive servicing data for 30 of the most popular UHF and VHF receivers now in use, including B&K, Browning, Johnson, Midland, Pace, Pearce-Simpson, Penneys, Realistic, Sonar, and Teaberry. As the first guide ever released for scanners and monitors, it is an invaluable aid for service technicians. Its last-minute information includes schematics, voltages, alignment, parts lists, crystal formula data, pictorial presentations, and general troubleshooting information.

No. 06557

\$4.95



## Special Discount Offer

All of the above are available from your Sams Distributor. Ask him how you can save 30¢ a volume on Transistor Radio Series and Modular Hi-Fi/Stereo Series by contracting for each volume as it is issued.



**HOWARD W. SAMS & CO., INC.**

4300 West 62nd St. • Indianapolis, Ind. 46268

Circle 21 on reader service card

# CIE graduate builds two-way radio service business into \$1,000,000 electronics company!

**How about YOU? Growth of two-way transmitters creates demand for new servicemen, field and system troubleshooters. Licensed experts can make big money. Be your own boss, build your own company. And you don't need a college education.**

Two-way radio is booming. There are already nearly seven million two-way transmitters for police cars, fire department vehicles, taxis, trucks, boats, planes, etc., and Citizens Band uses. And the number keeps growing by the thousands every month. Who is going to service them? You can — if you've got the know-how!

## Why You'll Earn Top Pay

One reason is that the United States Government doesn't permit anyone to service two-way radio systems unless he's *licensed* by the FCC (Federal Communications Commission).

Another reason is that when two-way radio men are needed, they're *really* needed! A two-way radio *user* must keep those transmitters operating at all times. And, they *must* have their frequency modulation and plate power input checked at regular intervals by licensed personnel to meet FCC requirements.

As a licensed man, working by the hour, you would usually charge at least \$5.00 per hour, \$7.50 on evenings and Sundays, plus travel expenses.

Or you could set up a regular monthly retainer fee with each customer. Your fixed charge might be \$20 a month for the base station and \$7.50 for each mobile station. Studies show that one man can easily maintain at least 135 stations—averaging 15 base stations with 120 mobiles! This would add up to at least \$12,000 a year.



Edward J. Dulaney, Scottsbluff, Nebraska, (above and at right) earned his CIE Diploma in 1961, got his FCC License and moved from TV repairman to lab technician to radio station Chief Engineer. He then founded his own two-way radio business. Now, Mr. Dulaney is also President of D & A Manufacturing, Inc., a \$1,000,000 company building and distributing two-way radio equipment of his own design. Several of his 25 employees are taking CIE courses. He says: "While studying with CIE, I learned the electronics theories that made my present business possible."

## Be Your Own Boss

There are other advantages, too. You can become your own boss — work entirely by yourself or gradually build your own fully staffed service company. Of course, we can't promise that you will be as successful as Ed Dulaney, or guarantee that you'll establish a successful two-way radio business of your own, but the opportunities for success are available to qualified, licensed men in this expanding field.

## How To Get Started

How do you break in? This is probably the best way:

1. Without quitting your present job, learn enough about electronics fundamentals to pass the Government FCC exam and get your Commercial FCC License.
2. Then get a job in a two-way radio service shop and "learn the ropes" of the business.
3. As soon as you've earned a reputation as an expert, there are several ways you can go. You can move *out* and start signing up and servicing your own customers. You might become a franchised service representative of a big manufacturer and then start getting into two-way radio sales.

Cleveland Institute of Electronics has been successfully teaching Electronics for over 37 years. Right at home, in your spare time, you learn Electronics step by step.

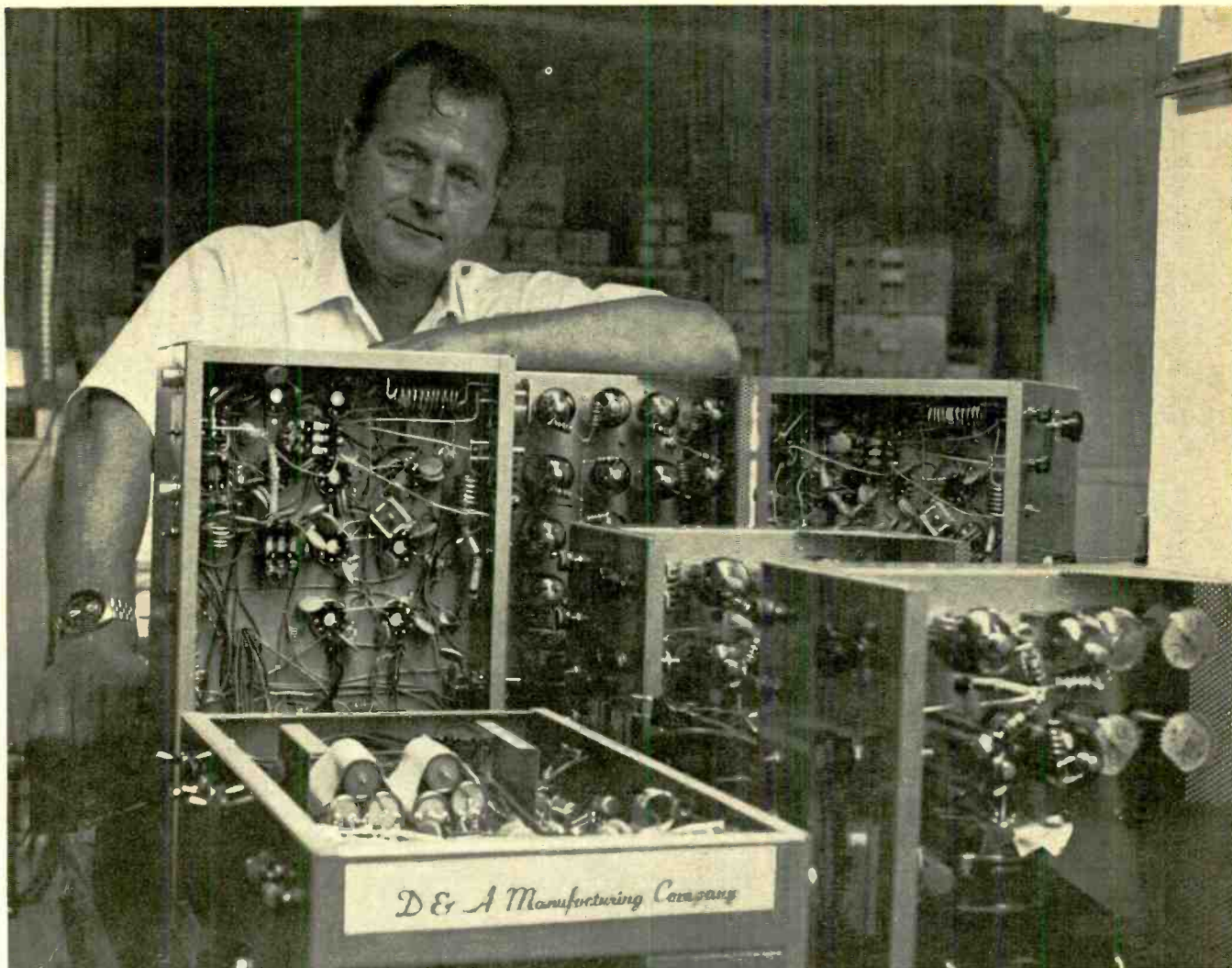

CIE's AUTO-PROGRAMMED® Lessons remove the roadblocks by using simple, concise examples. You learn in small, compact steps — each one building on the other!

You'll learn not only the fundamentals that apply to all electronics design and servicing, but also the specific procedures for installing, troubleshooting, and maintaining two-way mobile equipment.

**You Get Your FCC License . . .  
or Your Money Back!**

By the time you've finished your CIE course, you'll be able to pass the FCC License exam. A recent survey of 787 CIE graduates reveals that better than 9 out of 10 CIE grads passed the FCC License exam. That's why we can offer our famous Money-Back Warranty: when you complete any CIE licensing course, you'll be able to pass your FCC exam or be entitled to a full refund of all tuition paid. This warranty is valid during the completion time allowed for your course. You get your FCC License — or your money back!

**It's Up To You**

Mail the reply card for two FREE books, "Succeed in Electronics" and "How To Get A Commercial FCC License." For your convenience, we will try to have a representative call. If card has been removed, mail coupon or write: Cleveland Institute of Electronics, Inc., 1776 E. 17th St., Cleveland, Ohio 44114.

**APPROVED UNDER G. I. BILL**

All CIE career courses are approved for educational benefits under the G.I. Bill. If you are a Veteran or in service now, check box for G.I. Bill information.

 **CIE Cleveland Institute of Electronics, Inc.**

1776 East 17th Street, Cleveland, Ohio 44114  
Accredited Member National Home Study Council

**Please send me your two FREE books:**  
1. Your book on "How To Get A Commercial FCC License."  
2. Your school catalog, "Succeed in Electronics."

I am especially interested in:

<input type="checkbox"/> Electronics Technology	<input type="checkbox"/> Electronic Communications
<input type="checkbox"/> Broadcast Engineering	<input type="checkbox"/> Industrial Electronics
<input type="checkbox"/> First Class FCC License	<input type="checkbox"/> Electronics Engineering
<input type="checkbox"/> Electronics Technology with Laboratory	

Name \_\_\_\_\_ (Please Print)

Address \_\_\_\_\_

City \_\_\_\_\_

State \_\_\_\_\_ Zip \_\_\_\_\_ Age \_\_\_\_\_

**Veterans & Servicemen:** Check here for G. I. Bill information

RE-13

**SERVICE CLINIC**

(continued from page 72)

glect any of them. You can jar it, you can change the supply voltage, or you can heat it or cool it. Somewhere in this list, you should be able to find something that will make it show up. When you do, you've practically got it licked. **R-E**

# reader questions

**BLACKOUT EXPLANATION**

In this column in the October issue Jim Franks told us about a G-E that did not display a raster until the audio output tube was pulled. The basic trouble was due to a shorted .01- $\mu$ F capacitor on the blanking network. The accompanying diagram did not include the audio output circuit and the connection between the blackout and the audio circuit was not immediately obvious.

This TV receiver used a stacked B+ supply with the cathode of the audio output tube serving as the 135-  
(continued on page 80)

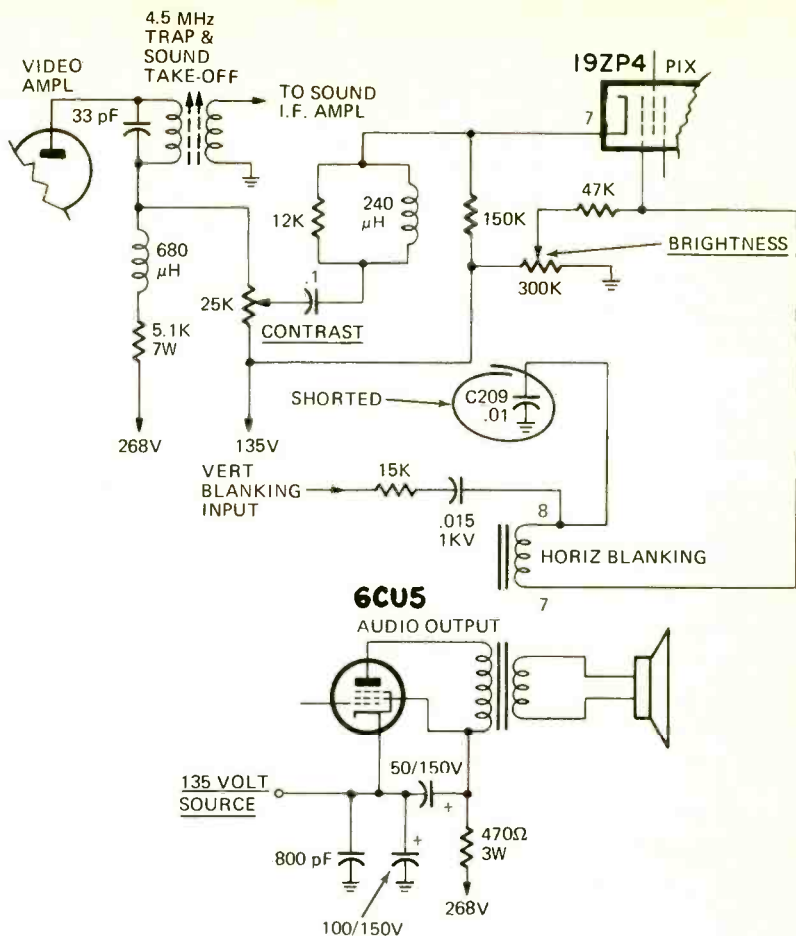

# INTERNATIONAL Frequency meter FM-2400CH

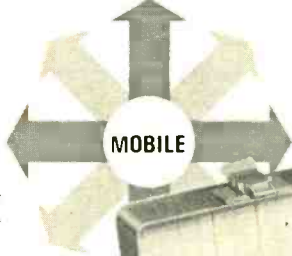

- Tests Predetermined Frequencies 25 to 1000 MHz
- Extended Range Covers 950 MHz Band
- Pin Diode Attenuator for Full Range Coverage as Signal Generator
- Measures FM Deviation

The **FM-2400CH** provides an accurate frequency standard for testing and adjustment of mobile transmitters and receivers at predetermined frequencies.

The **FM-2400CH** with its extended range covers 25 to 1000 MHz. The frequencies can be those of the radio frequency channels of operation and/or the intermediate frequencies of the receiver between 5 MHz and 40 MHz.

Frequency Stability:  $\pm .0005\%$  from  $+50^\circ$  to  $+104^\circ\text{F}$ .

Frequency stability with built-in thermometer and temperature corrected charts:  $\pm .00025\%$  from  $+25^\circ$  to  $+125^\circ$  (.000125% special 450 MHz crystals available).

Self-contained in small portable case. Complete solid state circuitry. Rechargeable batteries.

**WRITE FOR CATALOG!**



FM-2400CH (meter only)	\$595.00
RF crystals (with temperature correction)	24.00 ea.
RF crystals (less temperature correction)	18.00 ea.
IF crystals	catalog price



Circle 23 on reader service card

# if you go for four channel...

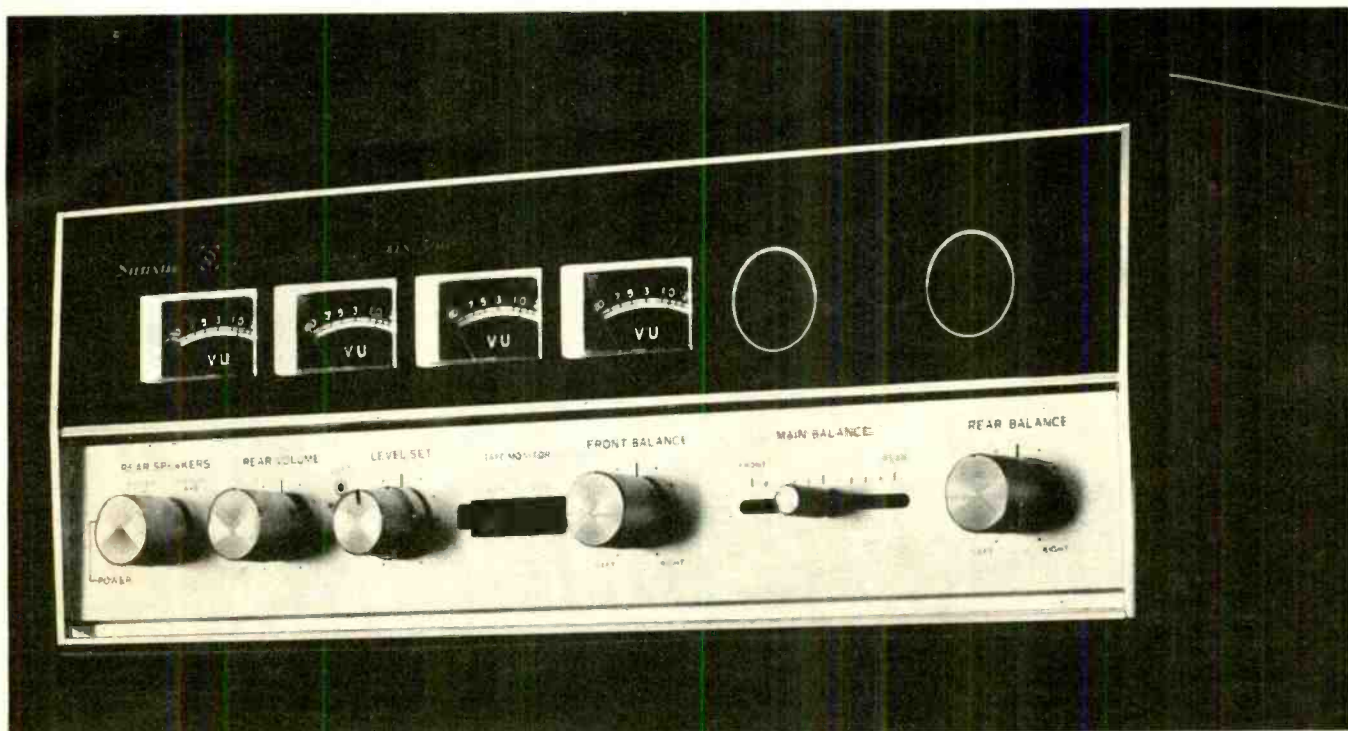

## you don't have to go for broke

Buy yourself a miracle for as little as \$214.95. That's all it takes to get your conventional two-channel stereo to do anything any total four-channel receiver and control center can do, now or in the future.

The Sansui QS500 and QS100 converters are complete Four-Channel Synthesizer-Decoder-Rear-Amplifier-and-Control-Center combinations that transform standard two-channel stereo totally. The only other equipment you need is another pair of speakers.

You can decode any compatibly matrixed four-channel broadcasts or recordings and reproduce them in four authentic channels. You can detect the ambient signals present in most two-channel recordings or broadcasts and propagate them through the rear channels. In Sansui matrixing, the exclusive phase-shift technique prevents the cancellation of some signals and the change in location of others that occur in many matrixing systems. And the exclusive phase modulators restore the effect of the live sound field.

You can plug in a four-channel reel-to-reel or cartridge deck or any other discrete source. In the future — if you should have to — you can add any adaptor, decoder or what-have-you for any four-channel system for disc or broadcast that anyone's even hinted at. And a full complement of streamlined controls lets you select any function or make any adjustment quickly and positively.

The QS500 features three balance controls for front-rear and left-right, separate positions for decoding and synthesizing, two-channel and four-channel tape monitors, electrical rotation of speaker output, alternate-pair speaker selection, and four VU meters. Total IHF power for the rear speakers is 120 watts (continuous power per channel is 40 watts at 4 ohms, 33 watts at 8 ohms), with TH or IM distortion below 0.5% over a power bandwidth of 20 to 40,000 Hz. In its own walnut cabinet, the QS500 sells for \$289.95.

An alternate four-channel miracle-maker is the modest but well-endowed QS100, with total IHF music power of 50 watts (continuous power per channel of 18 watts at 4 ohms and 15 watts at 8 ohms). In a walnut cabinet, it sells for \$214.95.

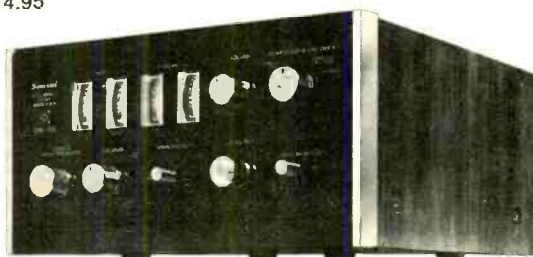

### SANSUI ELECTRONICS CORP.

Woodside, New York 11377 • Gardena, California 90274  
ELECTRONIC DISTRIBUTORS (Canada), Vancouver 9, B.C.  
SANSUI ELECTRIC CO., LTD., Tokyo, Japan • Sansui Audio Europe S. A., Antwerp, Belgium

Circle 24 on reader service card

**READER QUESTIONS**

*(continued from page 78)*

volt B+ source supplying, among other circuits, the cathode and grid of the picture tube (see diagram).

Normally, the cathode is biased at a fixed value of 120 to 130 volts and the control grid bias varies from 0 to 135 volts with the setting of the brightness control. When C209 shorted, it pulled the control-grid bias away down so the picture tube was cut off. Pulling the audio output removed +135 volts as a source of bias for the picture tube. The bias volt-

ages—now available from the 268-volt line through interconnecting resistor networks—are such that the picture tube is biased on so the raster returns.

**VERY THIN HORIZONTAL LINE**

This one happened to me, and it illustrates how reasoning intelligence (and a good deal of luck) will help. (A-Hem!) There was nothing but a very thin horizontal line on the screen of this Zenith portable; only one scanning line thick, really.

Applying the standard tests, I pulled the yoke, and read the resistance; fine. Resistance of yoke section of vertical output transformer also

fine. 9 ohms just as in the book. Tube good; dc voltages all good. With scope, no signal of any kind at any point in oscillator circuit.

Check all capacitors and resistors; they're good too. Now, try some of the clever little tests you keep telling other people to do, Darr. Clip lead to heater voltage at a 6-volt point. Feed this to grid of 10GK6 output section. Hmmm. Nothing. Still very thin line. Try higher voltage. 35 volts ac on grid, still nothing on screen. Up scope. Signal reads 35 volts (rms) on grid. On plate, about 2 volts peak-to-peak, at the most.

Well! Recheck dc voltages on output section just for luck. All present and accounted for. Now what's going on? Sit back and try something brand-new—THINK! *What* could cause an amplifier tube, with plenty of signal on its grid, to have absolutely zero gain?

One thing—a *load impedance* of absolutely zero ohms. Pick up ohmmeter, turn set off, read resistance of primary section of vertical output transformer. Is it 275 ohms, as it says on the schematic? It is not! It is just what you thought; absolutely zero. Replace transformer, everything lovely. (This was apparently a lead-short, from the very low resistance. It was in warranty, so I replaced it)

**MORAL**

There *is* always a legitimate, theoretically correct cause for everything, if you can just find it. **R-E**

**EQUIPMENT REPORT**

*(continued from page 32)*

reverse side of the chart shows a complete system hookup clearly diagramming all rear panel receiver connections.

Internal construction is on a number of printed circuit boards most of which have connectors for easy removal for repair or replacement. [Onkyo's attention to detail is completed by the inclusion of an assortment of phono plugs and speaker and line fuses along with a polishing cloth for the nicely veneered standard cabinet.]

After having seen and operated many stereo receivers in the past we are always suspicious of a new instrument. We try not to be misled by good looking mechanical construction and reserve our opinions until the equipment has been used for a few days and we are completely familiar with it. We were delighted with the TX-666 and the way it did not let us down. Take a good look at this one before making a final choice.

The TX-666 weighs 28 pounds and measures 18 3/8" wide by 15 1/2" deep by 5 1/2" high. **R-E**

# Leader

AUDIO TEST INSTRUMENTS

## Now You Can Say Service... and Smile!



**LV-77 FET MULTIMETER**  
Solid state dependability and stability plus high impedance—make this a fine general purpose meter. Has dual power supply—batteries and AC line. It's truly portable! ±3% full scale accuracy with easy to read, clearly marked face panel. **\$109.95**

**LFM-30 TAPE SPEED/CHECKER**  
Checks any tape recorder for speed and drift accuracy at 3KHz as well as 1, 2, 4, 5, 6, 7, 8 & 9KHz frequencies. 100MV to 10Vrms input level. ±5% end scale accuracy with -3% to +3% test range. Complete with carrying case. **\$129.95**



**LSW-250 FM-TV SWEEP/MARKER GENERATOR**  
Use with any scope to test and service FM, TV and more. Has 2-260MHz freq. range, cont. adjustable, with calibrated markings for most often used bands. Marking method is post injection with external signal input provision. Highly stable and accurate. With accessories. **\$309.95**



**LMV-89 2 CHAN. AC MILLIVOLT METER**  
Test stereo circuitry and 4-channel too—especially where differences exist in voltage at two separate points. ±3% full scale accuracy (1KHz); dB scale readings at 0dB=0.775V and 1V each. 2 chans. 100MV to 300V range in 12 steps. With separate pointers, individual switches, and amplifier systems. Both channels operate separately or together. **\$229.95**

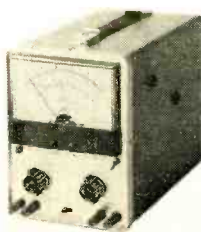

*Write for details. See your distributor.*

**The more you see ... the more you believe ... the more you save**

Leader Instruments Corp. 37-27 Twenty-Seventh St. L.I.C., N.Y. 11101 (212) 729-7410

*Circle 25 on reader service card*

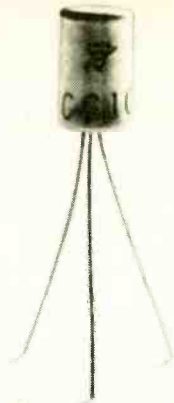

## Our ECG 102A transistor replaces...

To Be Replaced	ECG Replacement	To Be Replaced	ECG Replacement
11B33	102A	MA3831	102A
11B54	102A	MA3833G	102A
11B55	102A	MA3833R	102A
11B58	102A	MA815	102A
11B75	102A	MA881	102A
11B75C	102A	MA882	102A
11B77	102A	MA883	102A
11B77B	102A	MA884	102A
11B77C	102A	MA885	102A
11B156	102A	MA886	102A
11B156C	102A	MA887	102A
11B171	102A	MA888	102A
11B172	102A	MA889	102A
11B175	102A	MA890	102A
11B176	102A	MA891	102A
11B178	102A	MA892	102A
11B186	102A	MA893	102A
11B187	102A	MA894	102A
11B263	102A	MA895	102A
11B270	102A	MA896	102A

## and hundreds more.

The 102A is only one big part of our very small line.

Just 124 Sylvania ECG semiconductor parts will replace over 41,000 manufacturer's part numbers and JEDEC types.

Our new ECG semiconductor replacement guide makes it easy for you to find out exactly which one of ours is the one you need.

With our guide and our 124 replacements, you can service practically any solid-state entertainment product on the market.

No more lugging sets back to the shop because you couldn't carry all the parts you needed.

With Sylvania's 124 semiconductors you can handle almost all of your repair jobs right in your customer's home.

Stock up on Sylvania ECG semiconductors now.

It's just another small thing from GTE Sylvania that can take a big load off your back.

*Sylvania Electronic Components,  
Waltham, Mass. 02154*

**GTE SYLVANIA**

# new products

More information on new products is available from the manufacturers of items identified by a Reader Service number. Use the Reader Service Card inside the back cover.

**AUTOMATIC TURNTABLE, 42M Pre-Pack** includes choice of Shure or Pickering magnetic cartridge with elliptical stylus. Three-speed unit comes with base. Selected cartridge is premounted and accurately balanced in the pickup arm.

The turntable has a gimballed, low-



mass aluminum arm with a fixed counterweight balanced for the particular cartridge in the unit. A damped cueing and adjustable anti-skating device are also featured. \$90.85.—**Garrard**, Div. British Industries Company, South Service Road, Westbury, N.Y. 11590.

Circle 31 on reader service card

**DIGITAL ELECTRONIC CLOCK KIT, GC-1005** employs solid-state digital circuitry with illuminated readouts for hours, minutes and seconds. The electronics is contained in one large-scale integrated circuit. Secondary solid-state circuits drive the cold-cathode readout tubes and make up the power supply section



which can be pre-wired to accept either 120 or 240 Vac.

A 24-hour "beeper" alarm with seven-minute "snooze" button is included. The clock can be wired to display conventional or 24-hour international time. Alarm and time settings are made with hold-and-run switches in the clock base. Cabinet is black Cyclac

with walnut-finished vinyl trim. Following the simple step-by-step assembly manual, the electronic digital clock can be assembled in two evenings; no knowledge of electronics is necessary. \$54.99 plus shipping.—**Heath Company**, Benton Harbor, Mich. 49022.

Circle 100 on reader service card

**CB TRANSCEIVER, Prestige 2300** has easy-to-read dial indicator for quick channel identification. An accessory plug is provided for remote operation. In addition to operating in the AM mode for all 23 channels, the model may be used to monitor any of the 46 SSB channels in the Class D frequency.

Works on 12 volts dc. Model P5804A

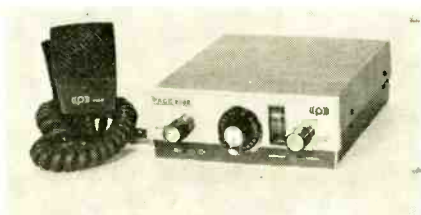

regulated power supply provides for easy conversion to base operation. A locking mobile mount and plug-in high-impedance ceramic microphone are included. Remote speaker and public address features are also provided.—**Pace Communications**, Pathcom, Inc., P.O. Box 306, Harbor City, Calif. 90710.

Circle 32 on reader service card

**CAR STEREO TAPE PLAYER, C976** is a theft-proof 8-track AM-FM-FM MPX car stereo tape player that is easily and professionally installed into the dash.

It features: five pushbutton AM/FM tuning, 8 watts output per channel on



FM and tape, local/distant switch, volume and tone controls, front-to-rear and left-to-right balance control and automatic and manual track switching.

The unit has a solid-state chassis with 18 transistors, 12 diodes and 4 in-

tegrated circuits and operates from 12 volts dc. Output impedance for the matched 4-speaker system is 8 ohms.

7 $\frac{1}{2}$ " x 3 $\frac{3}{8}$ " x 7"; 8.8 lbs.—**Audiovox Corporation**, 150 Marcus Blvd., Hauppauge, N.Y. 11787.

Circle 33 on reader service card

**CASSETTE TAPES, Professional series 261** uses wide-range full-fidelity tape. Torque-control liners are made of graphite coated polyester and the case is high-impact plastic with sealer windows. Tape guide system has lubricated stain-



less steel pins with rotating guide rollers.

Packed in unbreakable plastic albums, prices are \$1.80, \$1.85, \$2.90 and \$3.45 for 40-, 60-, 90- and 120-minute tape cassettes.—**Irish Magnetic Tape**, 270-278 Newton Road, Plainview, N.Y. 11803.

Circle 34 on reader service card

**BREADBOARD AID, Digi Designer** incorporates the SK-10 component socket, a variable, six position 1 to 100 kHz clock, four logic lamps, four switches, two bounce-free pushbuttons for use as pulsers and an internal 5-volt dc power supply. There are numerous terminal

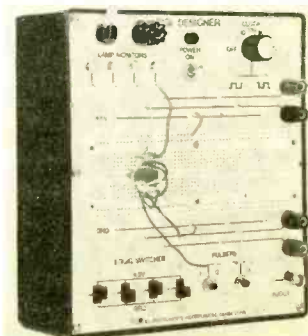

points on the front panel for external inputs or patch cords.

The model enables the user to completely design and test a circuit by merely plugging his components into the SK-10 socket and interconnecting with



standard No. 24 AWG hook-up wire. No soldering necessary.

Available in kit form \$49.95 or wired \$95.00.—**EL Instruments, Inc.**, 61 First Street, Derby, Conn. 06418.

Circle 35 on reader service card

**HEAT SINK, NC. 80** is used for absorption and dissipation of heat in soldering operations where adjacent, delicate elec-

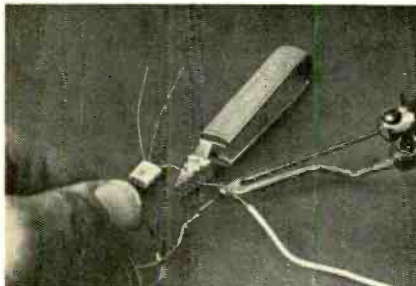

tronic parts might be damaged by overheating.

The copper jaws have nickel-plated surfaces to prevent adhesion of solder.

The spring-loaded gripping surfaces will not slip, yet have a smooth finish to prevent scratching fine wires. An insulating cushion grip permits burn-free handling.

3/4", weighs 1/2 ounce. \$2.40.—**Xcelite, Inc.**, Orchard Park, N.Y. 14127.

Circle 36 on reader service card

**MARKING AND ETCHING INSTRUMENT, Mark VII Electro Stylus** is precision made, rugged, dependable and easily handled. Weighs 7 ounces and is

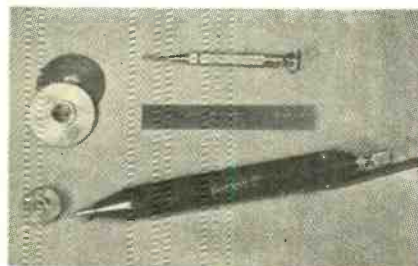

3/4" in diameter. It plugs into any ac outlet. Noise level is very low.

Electro Stylus is used to mark per-

manently tools, test equipment, TV's and radios.

\$19.95 with set of standard steel points, carbide point \$2.95 additional, diamond point \$7.95 additional.—**Electro Stylus**, 31 Cheyenne Blvd., Colorado Springs, Colo. 80906.

Circle 37 on reader service card

**INDOOR SPLITTERS & MATCHING TRANSFORMERS, models 3021 and 3022** are two-way splitters; models 3031 and 3032 are three-way devices and

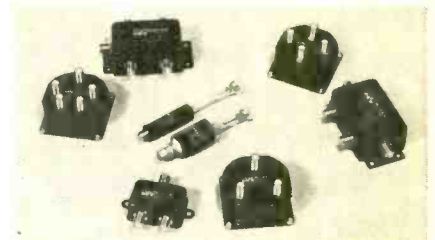

3041 and 3042 are four-way types. All have an output impedance of 75 ohms at all ports and operate over a bandwidth

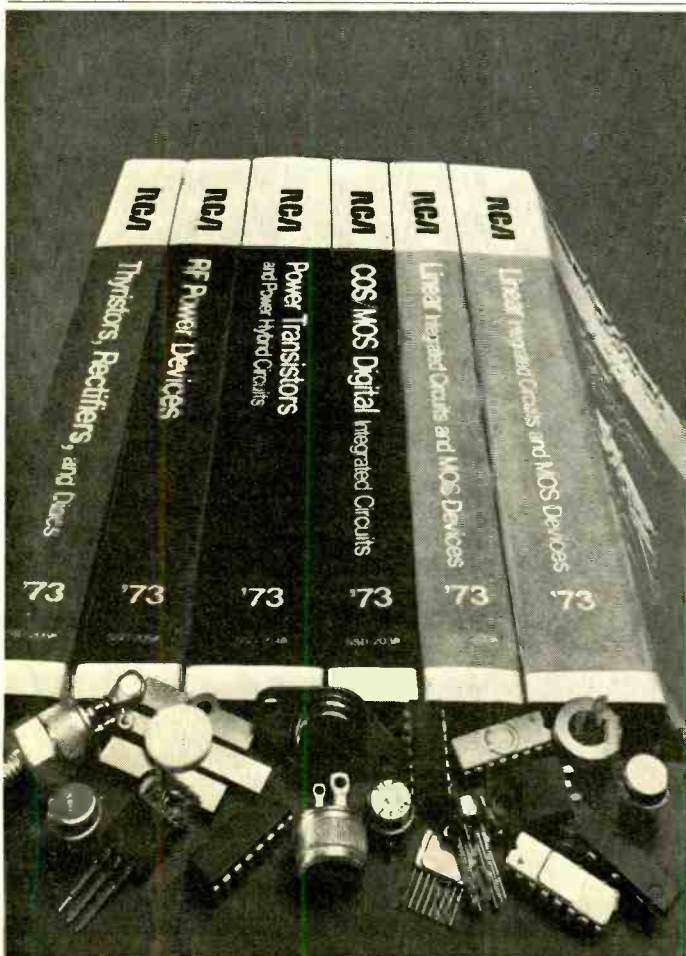

Circle 61 on reader service card

## It's time to order your 1973 RCA Solid State Databooks

Complete, up-to-the-minute data for RCA's IC's and discrete devices.

Get off to a fast start in 1973 with timely, comprehensive data from RCA, the company that specializes in complete, accurate data on all of its solid state devices.

The 1972 DATABOOKS have been used in thousands of plants in the United States and around the world. And even more plants will be reached in 1973. This is your chance to be one of the new recipients.

The new DATABOOKS cover a great range of your requirements because RCA has some of the broadest lines in the industry: linear and COS/MOS ICs, MOS-FETs, power transistors, power hybrids, RF and microwave devices, thyristors, rectifiers, and diacs.

25% new or revised material. Complete commercial product data. Complete, current application notes. Easier-to-use quick-reference guides. New, comprehensive subject index. Cross-reference index of developmental to commercial type numbers.

Six 1973 DATABOOKS for only \$12 (optional list price), with monthly new products newsletter. See coupon for details. Send the coupon along with your check or money order (payable to RCA Corporation) or your company purchase order. Or call your RCA distributor. If the coupon is missing, write RCA, Solid State Division, Section 132B, Box 3200, Somerville, N. J. 08876.

RCA Corporation  
Solid State Division  
Section 132B, Box 3200  
Somerville, New Jersey 08876

- Rush me the six 1973 DATABOOKS and put my name on newsletter mailing list. My cost, only \$12.  
 Rush me prices for individual DATABOOKS and updating service.

NAME/TITLE \_\_\_\_\_

COMPANY \_\_\_\_\_

ADDRESS \_\_\_\_\_

CITY/STATE/ZIP \_\_\_\_\_

I enclose payment by:  Check  Money Order  Purchase Order

Offer good only in U.S. and Canada. Direct other inquiries to RCA sales offices or distributors.



**SERVICEMASTER**  
is  
your best buy  
in domestic  
and  
foreign  
tubes.

- Discounted to provide you with a higher profit margin.
- Proven quality for better customer satisfaction.
- A complete range of domestic and foreign service types for consumer and industrial electronics.

For complete details, contact your International representative today, or International Components, 10 Daniel Street, Farmingdale, New York 11735/(516) 293-1500.

**SERVICEMASTER**  
**International** ©  
International Components Corp.  
Div. of IESC

Circle 62 on reader service card

of 5 to 300 MHz.

The transformers, *models 3000 and 3002*, also operate over the same bandwidth and are similarly rated except for mechanical configurations.—**GTE Sylvania, Inc.**, 730 Third Avenue, New York, N.Y. 10017.

Circle 38 on reader service card

**METAL CUTTING SNIPS.** A new line of aviation snips, metal snips and light metal and wire cutting snips are specially designed to yield maximum cutting power with minimum effort. Blades are scientifically heat-treated to assure uniform hardness, machine hollow ground

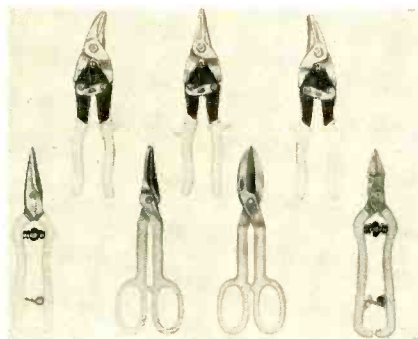

to provide long-lasting cutting edges and individually fitted to give uniform cutting action. Handles on all styles are equipped with dipped heavy vinyl, hand-ease cushion grips.—**Channellock, Inc.**, Meadville, Pa. 16335.

Circle 39 on reader service card

**AUTOMATIC DIALER, Name Caller.** New low-cost telephone dialer. Works on home and business telephones. You install it yourself, program up to 38 names with special pencil supplied with each



unit. Home model \$49.95; business model \$59.95.—**Video Systems, Inc.**, 12530 Beatrice Street, Los Angeles, Calif. 90066.

Circle 40 on reader service card

**ANSWERING SYSTEM, Ansafone 640** can be programmed in advance to set the time allowed for incoming messages.

The outgoing message cartridge is plugged inside the unit. The user lifts the hinged cover, plugs in the cartridge, connects a small hand-held microphone and records the outgoing message.

The incoming message controls are within easy reach and include an on-off and volume switch. When a call comes in, it is automatically answered, the message given and the recording begun in

one continuous and automatic cycle. Reproduction of the play-back cassette offers outstanding sound quality with signal-to-noise ratios of 35-40 dB.

8½ x 8½ x 5 inches, molded in

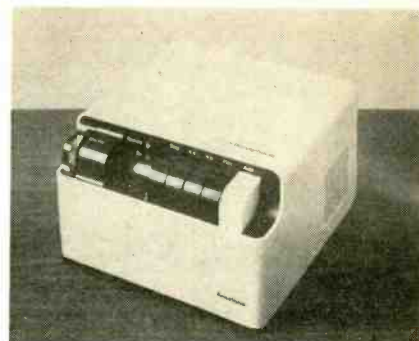

scuff-proof plastic with grey finish. \$325.—**Dictaphone Corporation**, 120 Old Post Road, Rye, N.Y. 10580.

Circle 41 on reader service card

**POCKET CALCULATOR KIT, AR-420K** provides all full four-function electronic calculation using an MOS/LSI integrated circuit. Entries are quickly made on a compact elastomer keyboard and answers are displayed in floating-point format on eight bright LED displays.

Chain features allow for long, mul-



ti-ple-step calculations. A constant-register makes multiple powers, conversions, reciprocals and (indirect) square roots easy to obtain.

9½ ounces, \$75 with batteries.—

**Aries, Inc.**, 119 Foster Street, Peabody, Mass. 01960.

Circle 42 on reader service card

**ALARM SYSTEM, SS-200** is a complete self-contained ready-to-install solid-state closed-circuit burglar alarm system. Opening any door or window, cutting the alarm wires or tampering with the cabinet sounds the alarm. A 25-30-second time delay eliminates the need for an on/off entrance door key switch and allows you sufficient time to shut the alarm off upon entering the apartment.

System includes: tamperproof weather-resistant steel cabinet with 8-inch alarm bell; front and rear tamper switches; solid-state control module with time delay; electrical switch lock with two keys; three pairs of closed-circuit window contacts; exit door contact (N.O.); interior on/off switch; panic/battery test switch; warning de-

icals; 100 feet of hook-up wire; installation instructions; operates on standard



12-volt lantern battery (not supplied); \$74.95.—EICO Electronic Instrument Co., Inc. 283 Malta Street, Brooklyn, N.Y. 11207.

Circle 43 on reader service card

**DIGITAL MULTIMETER KIT, IM-1202** can be assembled in two or three evenings. A 2½-digit cold-cathode readout ends parallax and interpolation errors. Accuracy is within 1% on dc volts, 1½% on ac volts and alternating and direct current, 2% on ohms. 29 selectable ranges measure voltages from 10 mV to 1000 V on dc, either polarity; 10 mV to 700 V rms on ac; 10 µA to 2 A on ac or dc and 1 ohm to 2 megohms on resistance.

Features include: three-wire line cord, dual-primary power transformer, overload protection on all ranges, iso-

lated floating ground, rugged heavy-gauge aluminum case, tinted viewing



window and universal banana jacks. \$79.95.—Heath Company, Benton Harbor, Mich. 49022.

Circle 100 on reader service card

**SOLID-TUBE, R-3AT2** is the solid-state high-voltage rectifier that replaces 3AT2, 3AW2, 3BL2, 3BM2 and 3BN2 vacuum tubes.



Operating without a filament, the R-3AT2 eliminates the need for filament

windings on the flyback transformer. It starts instantly, operates cool and reduces X-radiation.

Peak inverse voltage is 45 kV, peak repetitive forward current, 5 mA, average forward current, 5 mA and voltage drop is 50 volts at 5 mA.—Electronic Devices, Inc., 21 Gray Oaks Avenue, Yonkers, N.Y. 10510.

Circle 44 on reader service card

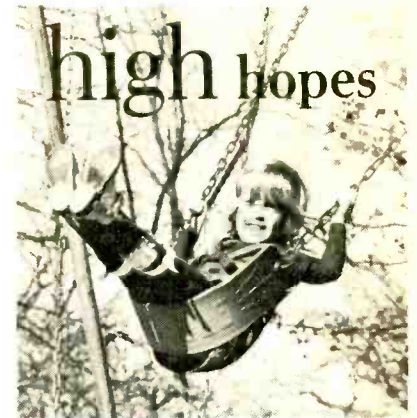

**birth defects  
are forever...  
unless you help**

**March of Dimes**

THIS SPACE CONTRIBUTED BY THE PUBLISHER

## NEA NATESA MEMBERSHIP PROGRAM

NEA -- 1309 West Market St. -- ITTA Bldg., Indianapolis, Ind. 46222

NATESA -- 5908 South Troy Street, Chicago, Ill. 60629

Service Dealer \_\_\_\_\_

Address \_\_\_\_\_

City \_\_\_\_\_ State \_\_\_\_\_ Zip \_\_\_\_\_

Per \_\_\_\_\_

All New Members must be signed up and approved by either NEA, or NATESA. (First Year dues paid -- \$35.00). (Dual Membership not acceptable).

EACH approved NEW NEA or NATESA Member will receive "gifts" from sponsors listed below in excess of \$40.00 (Retail Selling Price).

NEA and NATESA shall have the sole jurisdiction as to the pro-rating of "Gift Certificates" to their respective District, States or specific areas. Their decision shall be final.

We are very grateful to the Sponsors of this program and suggest our theme, "Support Your Supporters" be carried out.

SPONSORS:

AMPEREX ELECTRONIC CORP.  
TECH SPRAY  
THE FINNEY CO.  
ELECTRONIC DEVICES INC.  
INTERNATIONAL RECTIFIER

For further information as to how you can take advantage of this amazing offer, fill out and send the coupon to either NEA or NATESA. (Check preference)

MEMBERSHIP DRIVE ends March 31, 1973.

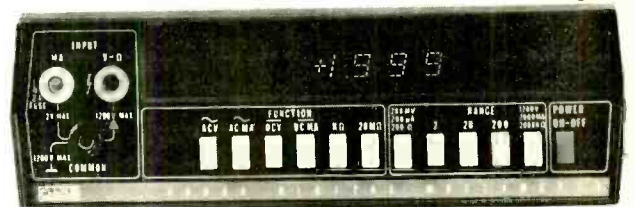

**\* New  
digital V.O.M. \$299**

- 26 ranges to measure ac/dc voltages from 100 microvolts to 1200 V, ac/dc currents from 100 nanoamperes to 2 amperes and resistance from 100 milliohms to 20 megohms.
- Basic dc accuracy, 0.1%.
- Guaranteed for one full year.
- Fluke gives you the best specs and strongest warranty on the market today for the lowest cost of ownership ever.
- Wide choice of options including rechargeable battery pack, digital printer output, deluxe test leads, high-voltage probe, RF probe, 200-amp ac current probe, carrying case, dust cover and rack mounts.
- Unique self-zero feature eliminates offset errors.
- Rugged high-impact case with securely mounted internal electronics.
- Service centers throughout U.S., Canada, Europe and Far East for 48-hour turnaround repairs.

**FLUKE**

P.O. Box 7428,  
Seattle, Washington 98133.

Get all the details from your nearest Fluke sales office. Dial toll-free 800-426-0361 for address of office nearest you.

Circle 63 on reader service card

# Whatever your tape handling needs...

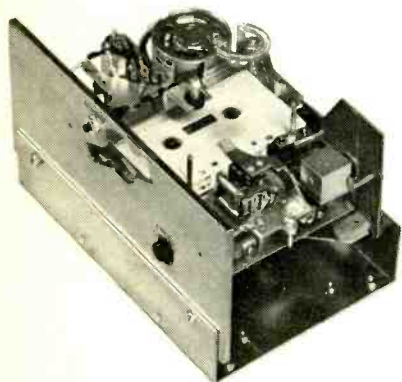

cassette...

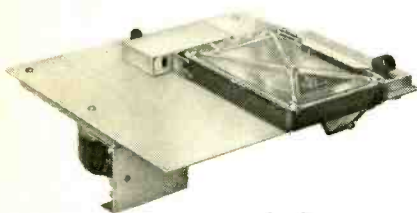

cartridge...

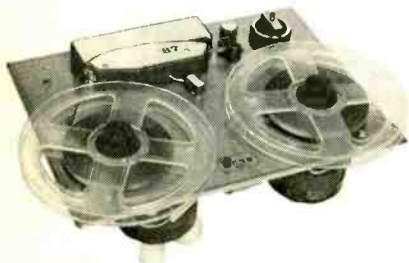

reel to reel...

Telex has an answer. Professional magnetic tape handling equipment, designed for heavy duty commercial and industrial use. Available with a wide choice of configurations, options and associated electronics. Write for free information.

PRODUCTS OF SOUND RESEARCH

## TELEX

COMMUNICATIONS DIVISION

9600 ALDRICH AVENUE SOUTH  
MINNEAPOLIS, MINNESOTA 55420

CANADA: DOUBLE DIAMOND ELECTRONICS, LTD., Ontario  
EUROPE: ROYAL SOUND COMPANY, INC., 409 North Main St., Freeport, N.Y. 11520 U.S.A.  
INTL: TELEX EXPORT DEPT., 9600 Aldrich Ave. So., Minneapolis, MN. 55420 U.S.A.

Circle 64 on reader service card

86 RADIO-ELECTRONICS • FEBRUARY 1973

# new literature

All booklets, catalogs, charts, data sheets and other literature listed here with a Reader Service number are free. Use the Reader Service Card inside the back cover.

**PRINTED CIRCUIT BOARDS CATALOG**, 12 pages of new sensitized printed circuit boards in this company's line of breadboard and printed circuit supplies. The catalog also gives information on chemicals used in electronic servicing and maintenance.—**Injectorall Electronics Corp.**, 98-100 Glen St., Glen Cove, N.Y. 11542.

Circle 45 on reader service card

**TECHNICAL BOOKS 1972-1973 Edition**. 28-page catalog describes more than 235 current and forthcoming books plus ten new electronic book/kits. Books listed in the catalog cover amateur radio, appliance repair, audio & hi-fi, basic technology, computer technology, electronic book/kits, electric motors, engineering & reference, general electronics servicing, hobby & experiment, license study guides, test equipment, transistors & semiconductors and TV schematic/servicing manuals.—**Tab Books**, Blue Ridge Summit, Pa. 17214.

Circle 46 on reader service card

**ELECTRONIC KITS 1973 catalog**. All kinds of electronic project kits including color TV's, audio equipment, marine gear, amateur radio equipment, automotive electronics, electronic organs, electronic clock, electronic calculators, security systems and a complete range of electronic test equipment. Complete descriptions of the kits and the specifications of the completed equipment are included in this 80-page catalog.—**Heath Company**, Benton Harbor, Mich. 49022.

Circle 47 on reader service card

**EXPERIMENTER'S CATALOG No. 731** contains more than 4,500 unusual bargains for experimenters and hobbyists. This 164-page catalog lists items in almost every area of interest from astronomy to weather instruments. Along the way are all kinds of electronic gear as well as items to fit the needs of associated hobby interests. While this is a catalog, it is most certainly also an interesting book to read.—**Edmund Scientific Co.**, 700 Edscorp Bldg., Barrington, N.J. 08007.

Circle 48 on reader service card

**FRONT PANEL COMPONENTS condensed catalog CC-72-8**. 12-page listing of miniature switches, toggles, push buttons, printed circuit types, etc.; high-quality aluminum and plastic knobs; isolation relays combining relay transformer and contacts in one small package; neon and incandescent 7-segment single-plane readouts, lamps and indicator assemblies; and ceramic terminal strips.—**Alco Electronic Products, Inc.**, 1551 Osgood Street, North Andover, Mass. 01845.

Circle 49 on reader service card

**PTS EXPANDS FACILITIES**. Bloomington, Indiana facilities have been doubled in size. The new plant includes provisions for repairing 8-track and cassette players in addition to the usual TV tuner repair facilities. More than 60 trained technicians at six PTS locations give the electronic technician the tuner and tape

player service he requires.—**PTS Electronics, Inc.**, P.O. Box 272, 5233 Hwy. 37 S., Bloomington, Ind. 47401.

Circle 50 on reader service card

**TOOLS CATALOG 1973 Edition**. A 64-page catalog of high-quality, professional tools and other products. The collection includes hard-to-find hand tools and small power tools used extensively by technicians, designers and service personnel. Many items listed in the catalog are rarely sold by industrial distributors or commonly found in stores.—**Brookstone Co.**, Peterborough, N.H. 03458.

Circle 51 on reader service card

Write direct to the manufacturers for information on items listed below:

**STEREOSCOPIC TELEVISION**. A new technical paper presented recently at a technical symposium. This paper surveys a number of 3-dimensional television systems and describes in particular the Stereotronics System which optically converts normally flat closed-circuit television into 3-D TV.—**Stereotronics Television Co.**, 13720 Riverside Drive, Sherman Oaks, Calif. 91408.

**TRANSISTOR SUBSTITUTION GUIDE catalog 276-2000**. This guide lists 15,000 commercial transistor types which in most cases may be directly replaced or substituted for with one of 29 Archer transistors. Detailed specifications and electrical characteristics for each of the 29 transistors are given in the booklet. 24 of them are custom made for Radio Shack by Texas Instruments and five are imported. The 96-page book also contains data on the care and handling of transistors, details on testing transistors and important suggestions on the use and replacement of transistors. The guide is priced at \$1.00.—**Radio Shack**, 2617 West Seventh Street, Fort Worth, Tex. 76107. R-E



"When you're finished, I'd like you to take a look at my husband."

**LETTERS**

*(continued from page 24)*

nal quality, and it is in these areas that matrixing just doesn't make it.

Discrete will give us these things, but at present will also limit the dynamic and frequency ranges. So let's just concentrate on our 2-channel systems (except with tape) and wait for the day when RCA announces that it has available those top two octaves and 30 dB more dynamic range (with Dolby C?). With the present speed of development in electronics, it shouldn't be longer than a couple years.

MICHAEL SABLOSKY, USIS-AM.  
EMB., APO San Francisco

**ABOUT STRIPES OF ANOTHER COLOR**

Some Stupid—)(\* + /%&%\* @—Put In The Wrong Resistor—or—The Case Of How To Solve A Color Problem By Making It Worse.

Some time ago, the problem of how to see a brown color stripe on a brown resistor was brought to the attention of resistor manufacturers. The resistor manufacturers responded with great haste (since they desire in every way to please all their customers).

However, the response has proven to be too much—too soon. The result—the brown color code paint was made more red, in fact, some brown color stripes are now red.

So . . . watch out for that brown color stripe. If the schematic shows a 680-ohm resistor and the third color stripe on the resistor looks red, don't be too sure the resistor is the wrong value—measure it. The rule to follow now is don't trust your eyes to see a brown color stripe on a resistor. That orange or red stripe could be the new industry Shade of Brown.

GTE SYLVANIA SERVICE BULLETIN



**"OPEN-AIRE" HEADPHONES** have all the makings of a perfect gift: professional quality and reasonable price. New design principle combines unusually light (5 oz.) weight, wide (20-20,000 Hz) response . . . all the realism of stereo without cumbersome size and uncomfortable ear seals. Give a gift of privacy and perfect sound. Only \$39.95 from Sennheiser Electronic, 10 W. 39 St., N.Y.C. 10018.

Circle 95 on reader service card

**The natural beauty that was once this country...**



America is suffering from pollution. But doesn't have to be. That's the tragedy. America can again be as beautiful as it once was. If we all get involved. Involved with things like putting trash in proper receptacles. Or carrying a litterbag in our cars. Let's restore the beauty that was once this country.

**People start pollution.  
People can stop it.**

**Keep America Beautiful**



advertising contributed for the public good

FREE



## The World's Largest Consumer Electronics Catalog

The world's Foremost consumer electronics catalog is yours for the asking! Over 25,000 items . . . jam-packed with illustrations and descriptions of the very latest in Hi-Fi, CB, Tape recorders, Radios, Television, Electronic Parts, Technical Publications.

Everything in Electronics For Home, Business, Industry PLUS The Latest in 4-Channel Stereo!

LAFAYETTE 1973 CATALOG 730

**Our 52nd Year**

**Stores From Coast-to-Coast**

**MAIL  
THE  
COUPON  
TODAY**

**LAFAYETTE RADIO ELECTRONICS**  
P.O. Box 10, Dept. 17023  
Syosset, L.I., N.Y. 11791

Send For Your Free Lafayette Catalog Today!

Send me the FREE LAFAYETTE Catalog 17023

Name \_\_\_\_\_

Address \_\_\_\_\_

City \_\_\_\_\_ State \_\_\_\_\_ Zip \_\_\_\_\_

Circle 69 on reader service card

## Need high temperatures in tiny places?

The amazing Little Torch is so tiny it can throw a flame of 6300°F. through the eye of a needle. It solders, brazes, welds and heats with exacting precision in the smallest places; uses oxygen and acetylene,

hydrogen, propane, natural gas or Mapp. It's available with five tips ranging in size from one large enough to weld 16 ga. steel to one small enough to weld .002" copper wire. For free brochure write to:



Dept. SS-2, 2600 Niagara Lane No., Minneapolis, Minnesota 55441

Circle 70 on reader service card

# try this

## LOUPE AIDS METER READINGS

A jeweler's loupe is a handy device for increasing visual resolution when reading small movements of meter pointers. It is especially useful when sensitive meters are not readily available. It can be used when measuring a true or a relative value.

To illustrate, you want to see if a particular circuit action causes an in-

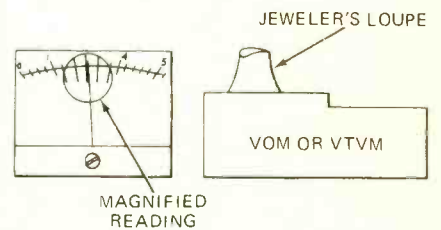

crease or decrease (a very small change) in the meter reading. Use the correct meter scale if you are interested in true values. For relative readings, use the scale that has the greatest number of minor divisions. You can detect any change more easily as a numerical value (two divisions, three divisions, etc.).—Alex Billos

## SIMPLEST "LIGHTS-ON" REMINDER

I needed a headlight/parking light reminder for a new car so I searched back issues of *Radio-Electronics* for a circuit. I found plenty of them—but each schematic specified one or more parts that I did not have in stock. I decided to design my own

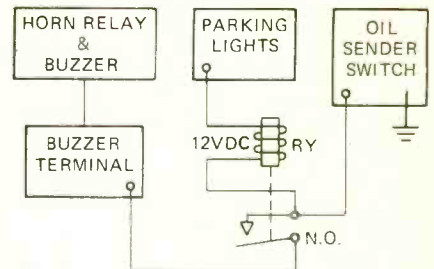

and came up with the one shown. No transistors, no diodes, no speakers—just a simple relay (12 volts dc, spst, normally open).

The new car has a buzzer that sounds when you open the driver's door without removing the ignition key. We use it for the "lights-on" reminder. The sketch shows the hookup.—E.A. Orlovsky

The "Country Boys" Have it!

## New Universal Type COLOR TV YOKE



REPLACES YOKES OF OVER 200 DIFFERENT MFR'S INCLUDING HITACHI, TOSHIBA AND NIVICO

Oneida's OCY-95 Universal Color TV Yoke does it all. It's the hottest item in the marketplace... being used in the following: Admiral, Airline, Ambassador,

AMC, Andrea, Arvin, Bradford, Catalina, Clairtone, Coronado, Curtis Mathes, DuMont, Electrohome, Emerson, Hitachi, Hoffman, Muntz, Nivico, Olympia, Packard-Bell, Penncrest, Philco-Ford, RCA, Sears Silvertone, Sylvania, Toshiba, Truetone, Westinghouse.

Standard warranty. Complete schematic and all manufacturers' part nos. enclosed with each unit.

See your local distributor. If he doesn't have it ask him to order a supply for you.



The "Country Boys" Appreciate Your Business

ONEIDA ELECTRONIC MFG. INC.  
MEADVILLE, PA. 16335



George Dalton

ELECTRONIC  
MFG. CO.

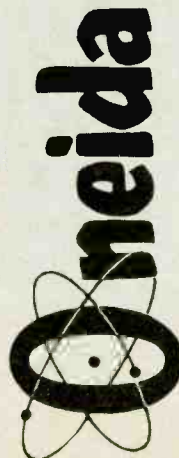

Circle 71 on reader service card

**LOW COST KEYBOARDS**

*(continued from page 57)*

shift, keys that shift, and the ability to use "control" keys that do not enter a character but that tell things at the other end to start, stop, linefeed, carriage return, change mode, clear, etc. These are called *transparent* commands and you'll find out more on them in another article.

Somehow the keys have to be arranged to end up with all these functions and still have a reasonable number of leads coming out of the keyboard. If we bring everything out, there would be 110 contacts and 110 wires. If we go to a common contact on each key, this drops to 56 contacts, still a ridiculous number and worse yet, we'd find the encoder got more complex in the bargain. To get around this, we arrange the keys in a *pre-encoder* matrix. This matrix is shown in Fig. 9. It simply groups keys that are

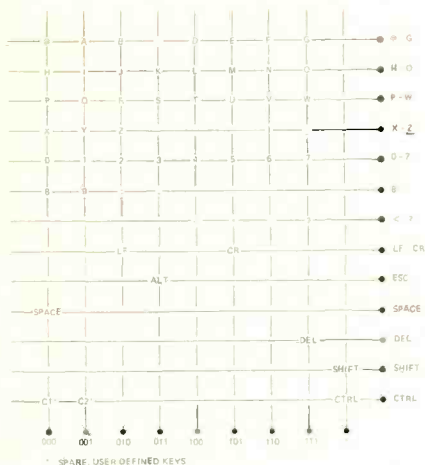

FIG. 9—PRE-ENCODER MATRIX groups the related keys to simplify the encoding scheme.

related in the encoder together. You end up with only 22 connections on the keyboard's output connector and still can use an extremely simple encoding scheme. The pre-encoder is designed specifically for the ASCII encoder to be described in another article. You wire the pre-encoder by providing 100 jumpers as shown on the top of the PC pattern; these can be quickly "sewn" into the board in one continuous run; you then cut off the unwanted jumpers you get on the back side, and the job ends up much simpler than it seems at first.

Should you want another code, you simply work up your own pre-encoder matrix by changing the jumpers. The matrix has purposely been kept this flexible so you can use this keyboard in many systems without added expense or unreasonable modifications. If you are absolutely sure of

*(turn page)*

An outstanding offer for the engineer, student or hobbyist.

## The XR205 monolithic WAVEFORM GENERATOR KIT

Only **\$28.00**

Here's a highly versatile laboratory instrument for waveform generation at a fraction of the cost of conventional waveform or function generators.

The Kit contains:

- 1) Two XR205 waveform generator IC's
- 2) Data sheet and applications notes
- 3) PC board (etched and drilled, ready for assembly)
- 4) Detailed assembly and hook-up instructions with parts list, schematic and layout diagram.

Immediate delivery.

Order direct from:  
**EEP CORPORATION**  
 10180 W. JEFFERSON BLVD.  
 CULVER CITY, CA. 90230 213/838-1912

*Circle 65 on reader service card*

**GIVE... so more will live HEART FUND**

Contributed by the Publisher

first time at this low price!

**ALL-IN-ONE**

# VOM/TRANSISTOR TESTER

**MODEL HM-310** **\$49<sup>95</sup>** limited time

- 100 K $\Omega$ /V Taut Band movement, Mirrored Scale
- Burn-Out Protection
- Transistor Alpha & Beta
- Transistor Ico
- Measures Capacitance
- Self-contained
- Measures AC/DC Volts, Current, and Ohms in 22 Ranges

**OTHER QUALITY METERS . . .**

- Model HM-312 full range VOM . . . \$35.75
- Model HM-315 Transistor/Diode tester . . . \$34.65

**Reg. \$59<sup>95</sup>**

PLEASE SEND \_\_\_\_\_ MODEL \_\_\_\_\_

ENCLOSED IS \$ \_\_\_\_\_

SEND C.O.D.  
(Add \$2 for shipping and handling. Calif. add 5% tax)

Please send FREE Data Sheet

NAME \_\_\_\_\_

ADDRESS \_\_\_\_\_

CITY \_\_\_\_\_

STATE \_\_\_\_\_ ZIP \_\_\_\_\_

Prices and specifications subject to change without notice

**hm electronics, inc.**  
 10975 SAN DIEGO MISSION ROAD  
 SAN DIEGO, CALIFORNIA 92108  
 TELEPHONE: (714) 280 6050

*Circle 66 on reader service card*

# NEW

## from endeco



### The Pencil Soldering Iron with Operating Light, 2 Heats and On/Off Switch

**\$10.95**  
NET



Model 540S  
Soldering Iron  
Length 8 1/2"  
Weight 2 oz.

- Light shows when it's on
- 2 heats—20w and 40w—for any job
- Ironclad tips for longer life
- Cool, unbreakable polycarbonate handle
- Burn-resistant neoprene cord
- Converts to a desoldering iron with low cost attachment

### The Pencil Desoldering Iron with Operating Light, and On/Idle/Off Switch

**\$15.95**  
NET



Model 510 | Length 8 1/2"  
Desoldering Iron | Weight 3 1/2 oz.

- Light shows when it's on
- Operates at 40w; idles at 20w for longer tip life
- 6 tip sizes available to handle any job
- Cool, unbreakable polycarbonate handle
- Burn-resistant neoprene cord
- Exclusive new bracket insures alignment, prevents damage

#### New kits also available!

- Soldering Kits • Desoldering Kits
  - Soldering/Desoldering Kits
- See your distributor or write ...



5127 EAST 65TH ST.  
INDIANAPOLIS,  
INDIANA 46220  
PHONE 317 / 251-1231

enterprise  
development  
corporation

## EQUIPMENT REPORT

(continued from page 26)

straightforward with the exception of the subtraction function. This operation is done the same as addition except a special equal sign reserved for this purpose is used. This quirk soon becomes second nature. Entering a number with too many digits lights the overrange indicator as does a calculated result outside of the -99,999,999 to +99,999,999 range. When this indicator lights further calculations are locked out since they would lead to erroneous results. The keyboard worked well with a sensitive touch despite the lack of tactile and audible feedback.

Anyone purchasing the kit should seriously consider the charger/ac power option. Some of the components for this option are added to the clock/power supply board.

If you are an experienced kit builder the Aries calculator kit will give you a cache of arithmetic power that you can conveniently carry in your jacket pocket with its 3 13/16 x 4 3/8 x 1 1/4 inch dimensions. Sold by B & F Enterprises for \$75 the recommended charger/ac power option is \$17.50 including the four nickel cadmium AA cells. **R-E**

## LOW COST KEYBOARDS

(continued from page 87)

the pattern you want, a double-sided PC board may be used, but this freezes your design and ups the cost.

Assembly of the big keyboard is pretty much the same as the smaller ones. Two blank keys are provided; they are ASCII encoded as "can" and "em". This lets you transparently pass two special commands on for the rest of your system without needing to press the CONTROL button. You can make it do anything you like on the other end.

#### PARTS LIST (12-key keyboard)

- 12 Keytops, two shot molded plastic, 0-9, (.), and (t)
  - 12 Contact stems per Fig. 1 & Fig. 2
  - 1 2" x 2" contact pad material, carbon urethane sponge 1/4" thick. Cut into 0.4" square keypads
  - 1 2" x 2" damping pad material, 1/16" soft rubber cut into a dozen 1/2" round damping pads
  - 1 Extension spring, 1/4" i.d. x 3" long x .016 music wire. Stretch to Fig. 2-e and cut every 9th turn, forming a dozen keysprings
  - 1 Top panel per Fig. 3 and text 3 1/2" x 2 7/8" x 1/16" fiberglass or other insulator
  - 1 Bottom panel, 1/16" plated PC material per Fig. 3 and text 3 3/4" x 2 7/8" x 1/16"
  - 4 6-32 x 3/8" threaded spacers
  - 4 6-32 x 1" machine screws
  - 4 6-32 nuts
  - 4 No. 6 shakeproof washers
- MISC: solder and rosin flux; optional adhesive; template for contact stem assembly

#### PARTS LIST (55-key keyboard)

- 55 Keytops, two shot molded plastic, standard ASCII characters and spacebar
  - 57 Contact stems per Fig. 1 & Fig. 2
  - 1 4" x 4" contact pad material; cut into 57 0.4" square contacts
  - 1 4" x 4" damping pad material, cut into 57 0.5" round damping pads
  - 4 Extension springs, cut into 57 springs after extending
  - 1 Top panel, insulated PC material, 4" x 4"
  - 1 Bottom panel, per Fig. 6; 6 3/4" x 14"
  - 2 Support brackets, 14" long
- MISC: Threaded spacers, shrink tubing, and mounting hardware; No. 24 solid wire; solder; optional glue or epoxy; keystem soldering template.

Contact material is available from Custom Materials, Inc., 279 Billerica Rd., Chelmsford, Mass. 01824. It's their #7611 Velofoam 1/4" thick, and runs around 1/4¢ per keytop, but is only available in large sheets.

Keytops are available from Mechanical Enterprises, 5249 Duke St., Arlington, Va. 15¢ each, any reasonable callout. Space bars are 35¢ each. \$2 service charge on orders under \$25.

#### Other configurations

You can easily work up other arrangements for this low cost keyboard. Even if you only need a few pushbuttons for an electronic lock, music synthesizer or game, this system easily adapts itself and its real beauty is that you can custom design your own. **R-E**

## The Most Advanced Design in Color Combo Antennas

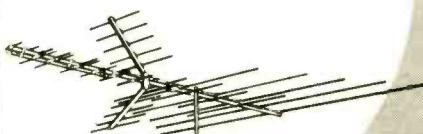

### THE ALL-CHANNEL C.V.U.

In these antennas the best features of the log periodic and magnetically driven arrays with an exclusive corner reflector magnetic wave UHF section to make it a top performer. The unique feature of this system is the ability to discriminate between desired signal and unwanted noise. Sharp, vibrant life-like color plus FM stereo listening at its finest.

Investigate now!

## S & A ELECTRONICS

Phone 419-693-0528  
202 W. Florence St. Toledo, Ohio 43605

Circle 68 on reader service card

Circle 67 on reader service card





## 12 REASONS YOUR CAR NEEDS A TIGER 500

Instant starting in any weather - Eliminates tune-ups - Increases gas mileage - Increases horsepower 15% - Improves acceleration & performance - Spark plugs and points last up to 70,000 miles - Reduces engine maintenance expense - Amplifies spark plug voltage to 45,000 volts - Maintains spark plug voltage to 10,000 RPM - Reduces exhaust emissions - Dual ignition switch - Unconditional guarantee for original owner - Installs in 10 minutes on any car with 12 volt negative ground - No rewiring - Most powerful, efficient and reliable Solid State Ignition made.

SATISFACTION GUARANTEED  
or money back.

Assembled . . . . . \$49.95

Post Paid in U.S.A.

Send check or money order with order to:

**Tri-Star Corporation**

Dept. R, P. O. Box 1946  
Grand Junction, Colorado 81501  
DEALER INQUIRIES INVITED  
Circle 72 on reader service card

## HANDY TRANSISTOR PULLER

Here are details on a handy transistor puller that you can make in just a few minutes. It was described in a recent issue of *GTE Sylvania Service Notebook*. All you need is one alligator clip and a 3-inch long thin screw or bolt.

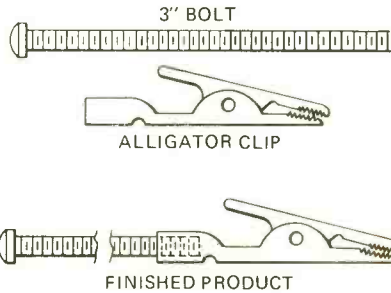

Use gas pliers to flatten and turn up the tip of the lower jaw of the alligator clip. The turned up tip forms a lip to catch the transistor case for better pull ability. Screw the bolt into the clip shank and solder securely as shown.

## EXTENSION HANDLE FOR TWEEZERS

A handy extension handle for tweezers can be readily devised by using a spring-type clothes pin. Taper both jaws of the clothespin and attach the tweezers to one jaw with a strip of tape. Position the tweezers so the pincher ends are held closed by the spring action of the clothespin. When the clothespin jaws are opened, the tweezer also opens.

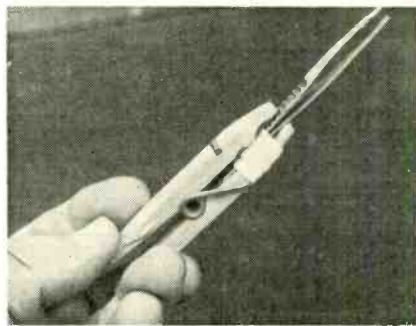

This quickly improvised tool (see photo) is most effective in inserting pins, screws and keys in close quarters.—Glen F. Stillwell **R-E**

# TV TECH CHOPS DOWN PRICES FOR WASHINGTON'S BIRTHDAY!

## MULLARD TUBES

5-3A3	\$4.95
5-6BL8	3.00
5-6BZ6	4.00
5-6DW4	4.95
5-6EA8	4.75
5-6EH7	4.25
5-6EJ7	4.00
5-6FQ7	3.50
5-6GY6	4.00
5-6HZ6	3.50
5-8FQ7	3.50
5-6HB7(Admiral)	4.25

300 Asst'd Resist. 1&2 Watt	\$4.95
100 Mlca Cond. Asst'd	\$1.49
20 Asst'd Mallory Controls	\$2.49
25 Asst'd Cond. (Cans)	\$4.95
25 Asst'd Cond. (Axial)	\$4.95

## DIODES—SEMI CONDUCTORS

HEP 170-2.5 Amp. 1000 PIV	25 for \$4.95
6500 PIV Focus Rect.	4 for \$2.00
13.5 KV Focus Rect.	5 for \$3.00
18.5 KV Focus Rect.	3 for \$2.49
Sel. Boost Rect.	5 for \$2.00
Crystal Diodes 1N34A	25 for \$2.00

## CONDENSERS—AXIAL LEADS

25 mfd.	25 Volts	5 for \$1.00
50 mfd.	50 Volts	4 for \$1.00
50 mfd.	150 Volts	6 for \$1.49
100 mfd.	150 Volts	12 for \$1.98
1000 mfd.	50 Volts	6 for \$2.49
30 mfd.	450 Volts	6 for \$1.98

## CONDENSERS—(CANS)

300 mfd.	150 Volts	3 for \$1.98
500 mfd.	200 Volts	2 for \$1.98
300 mfd.	200 Volts	4 for \$1.98

## PHONO EQUIPMENT

Mono Tone Arms TO Cart	2 for \$2.19
Stereo Tone Arms TO Cart	2 for \$2.98
Equiv. Astatic 133 Boxed	\$3.19 ea.
Equiv. Astatic 142	\$2.79 ea.
Equiv. Astatic 13TX Boxed	\$2.98 ea.
Equiv. Sonotone 8T Boxed	\$2.98 ea.
Equiv. BSR5H Boxed	\$2.49 ea.
Equiv. Euphonics U-1 Boxed	\$2.49 ea.
Equiv. EV 275 Boxed	\$3.59 ea.
Equiv. EV 5015	\$3.59 ea.
RCA Phono Plugs	10 for \$1.00
Knife Switches DPDT	4 for \$1.00
4 Align. Tools Asst'd.	\$1.19

MINIMUM ORDER \$15.00

SEND FOR FREE CATALOG

TUBES UP TO 80% OFF

SEND CHECK OR  
MONEY ORDER

## TV TECH SPECIALS

P.O. BOX 603

Kings Park, L.I., New York 11754

Circle 74 on reader service card

# EDI

**THOUSANDS OF BARGAINS—TOP VALUES IN Electronic Parts**

Transistors, Modules, Speakers, Stereo, HI-FI, Photo Cells and thousands of other Electronic Parts. Send for **FREE** Catalog

**ELECTRONIC DISTRIBUTORS INC.**  
Dept. TA-2, 4900 Elston  
Chicago, Ill. 60630

RUSH CATALOG

Name \_\_\_\_\_

Address \_\_\_\_\_

City \_\_\_\_\_ State \_\_\_\_\_ Zip Code \_\_\_\_\_

Circle 73 on reader service card



"Don't look now, but I think our challenge of the day has arrived."

# 12 exciting new Heathkit® projects you can assemble yourself ...and save!



(There are 350 more in your free '73 Heathkit Catalog)

## NEW Heathkit 21V Color TV — Solid-State Plus Detent UHF Tuning ... 499.95\* less cabinet

Power detent selection of all VHF and any 12 pre-selected UHF channels; exclusive angular tint control for consistently better flesh tones; voltage controlled varactor UHF tuner & MOSFET VHF tuner for unmatched sensitivity; black matrix tube, built-in dot generator, convergence panel and volt-ohm meter — full remote control options, too. It's Heathkit TV at its finest in a space-saving size. Kit GR-271, less cabinet, 121 lbs.

Assembled GRA-501-21, table model cabinet shown, tough walnut Marlite® finish, 33 lbs. .... 54.95\*

## NEW Heathkit 30 MHz Counter ... 169.95\*

Gives 1 Hz to over 30 MHz counting on a full 5-digit readout with 8-digit capability. The lighted overrange indicator makes misreading virtually impossible. Stable timebase circuitry assures accuracy better than  $\pm 3$  ppm from 22° to 37° C. Diode protected J-FET gives improved triggering over 100 mV to 150 V input range. Solid-state circuitry mounts on one large board. Kit IB-1100, 6 lbs.

## NEW Heathkit 2½-Digit VOM ... 79.95\*

Four overlapping ranges to measure voltages from 10 mV to 1000 V on DC (either polarity), 10 mV to 700 V rms on AC, 10  $\mu$ A to 2.5 A on AC or DC current. Five resistance ranges measure from 1 ohm to 2 megohms. Front panel polarity switch reverses inputs without changing leads. Kit IM-1202, 6 lbs.

## NEW Heathkit/Thomas Spinet Organ with two 44-note keyboards ... 689.95\*

Full 44-note keyboards for Solo and Accompaniment, exclusive Color-Glo keys that light up to indicate notes and chords. There are six solo stops, five accompaniment stops, plus both regular and a new "light" vibrato effects. Other features include keyboard jacks for private earphone listening or use of a tape cassette deck. Cabinet is shipped fully assembled, includes bench. Kit TO-1160, 211 lbs.

## NEW Heathkit 4-Channel Amplifier with "Universal" decoder circuitry ... 359.95\*

You select discrete 4-channel, or switch-in the "Universal" decoder for reproduction of all the matrixed 4-channel discs now on the market, plus "derived" 4-channel from conventional stereo. Four solid-state amplifiers produce 200 watts (4x50 IHF) into 8 ohms, with power bandwidth on all channels from less than 5Hz to greater than 45 kHz at 0.25% distortion. Kit AA2010, 37 lbs.

AAA-2004-1, pecan cabinet, 7 lbs. .... 24.95\*

## NEW Heathkit "Universal" 4-Channel Decoder ... 39.95\*

Reproduces all matrixed discs, plus "derived" 4-channel from conventional stereo material. Plug it into your receiver's tape monitor circuit, add a second stereo amp and speakers and you're set. Kit AD-2022, 4 lbs.

## NEW Heathkit Ultrasonic Intrusion Alarm ... 49.95\*

Disguised as an ordinary library book, this novel device fits unobtrusively anywhere in the home or office, yet detects any significant movement in the room, ultrasonically. The transmitter disperses a 41 kHz signal which bounces off walls & returns to the receiver where it's monitored for any change in amplitude. The device triggers lights and any conventional alarm device — just plug them into AC outlets on the rear panel. Can be installed anywhere there's a 120 VAC outlet. An enjoyable 2-evening kit ... for a lifetime of reliable home security. Kit GD-39, 5 lbs.

## NEW Heathkit 8-Channel VHF Band-Scanning Monitor with digital readout ... 119.95\* less crystals

Crystal-controlled monitor tunes any selected 9 MHz segment of the 146 through 174 MHz band — gives you police, fire, marine, ham 2-meter, etc. Features manual or automatic scanning with numerical readout; priority channel; built-in speaker and rear-panel jack for remote speaker; gimbal bracket for either base-station or mobile use. Operates on either 120/240 VAC or 12 VDC. Includes crystal OSC/Mixer signal source for easy alignment. Order up to eight Crystal Certificates with kit. Kit GR-110, 9 lbs.

GRA-110-1, Crystal Certificate, postpaid ..... each 4.95\*

## NEW Heathkit Engine Analyzer ... 64.95\*

For 3, 4, 6 and 8-cylinder engines. Includes leads and accessories for testing conventional, transistor, and magneto ignition systems, regardless of voltage or grounding. Uses 3 "C" batteries (not included). Kit CM-1050, 9 lbs.

## NEW Heathkit C-D Ignition System ... 39.95\*

Increases spark-plug and point life up to 50,000 miles on any car or truck using a 12-volt, negative ground system. Automatically varies spark duration. Screw-on terminals make installation easy; external pushbutton lets you override system without removing leads. Kit CP-1060, 4 lbs.

## NEW Heathkit 6-Digit Electronic Alarm Clock ... 54.95\*

Displays hours, minutes and seconds on highly visible cold-cathode readout tubes. A gentle "beeper" alarm can be set for 24-hour cycle and features a snooze switch that gives you seven more minutes of sleep before the alarm sounds off again. Conventional 12-hour or 24-hour international time display. Kit GC-1005, 4 lbs.

## NEW Heathkit Dolby® Cassette Deck ... 249.95\*

A kit-form cassette deck utilizing the famous Dolby® noise reduction system. Accommodates the greater fidelity and dynamic range of chromium dioxide cassettes. Independent switches provide Dolby on/off and regular or CrO<sub>2</sub> bias control. Domestic-make tape transport comes preassembled for easy kit building. Kit AD-1530, 21 lbs.

See them all at your nearest Heathkit Electronic Center ... or send for FREE '73 Heathkit Catalog.

HEATH COMPANY, Dept. 20-2 Benton Harbor, Michigan 49022		HEATH Schlumberger
<input type="checkbox"/> Please send FREE Heathkit Catalog. <input type="checkbox"/> Enclosed is \$ _____, plus shipping.		
Please send model(s) _____		
Name _____		
Address _____		
City _____	State _____	Zip _____
Prices & specifications subject to change without notice. *Mail order prices; F.O.B. factory. CL-453		

HEATHKIT ELECTRONIC CENTERS — ARIZ.: Phoenix, 2727 W. Indian School Rd.; CALIF.: Anaheim, 330 E. Ball Rd.; El Cerrito, 6000 Potrero Ave.; Los Angeles, 2309 S. Flower St.; Pomona, 1555 Orange Grove Ave. N.; Redwood City, 2001 Middlefield Rd.; San Diego (La Mesa), 8363 Center Dr.; Woodland Hills, 22504 Ventura Blvd.; COLO.: Denver, 5940 W. 38th Ave.; CONN.: Hartford (Avon), 395 W. Main St. (Rte. 44); FLA.: Miami (Hialeah), 4705 W. 16th Ave.; GA.: Atlanta, 5285 Roswell Rd.; ILL.: Chicago, 3462-66 W. Devon Ave.; Downers Grove, 224 Ogden Ave.; IND.: Indianapolis, 2112 E. 62nd Ave.; KANSAS: Kansas City (Mission), 5960 Lamar Ave.; MD.: Baltimore, 1713 E. Joppa Rd.; Rockville, 5542 Nicholson Lane; MASS.: Boston (Wellesley), 165 Worcester St.; MICH.: Detroit, 18645 W. Eight Mile Rd. & 18149 E. Eight Mile Rd.; MINN.: Minneapolis (Hopkins), 101 Shady Oak Rd.; MO.: St. Louis, 9296 Gravois Ave.; N.J.: Fair Lawn, 35-07 Broadway (Rte. 4); N.Y.: Buffalo (Amherst), 3476 Sheridan Dr.; New York City, 35 W. 45th St.; Jericho, L.I., 15 Jericho Turnpike; Rochester, Long Ridge Plaza; OHIO: Cincinnati (Woodlawn), 10133 Springfield Pike; Cleveland, 5444 Pearl Rd.; PA.: Philadelphia, 6318 Roosevelt Blvd.; Pittsburgh, 3482 Wm. Penn Hwy.; TEXAS: Dallas, 2715 Ross Ave.; Houston, 3705 Westheimer; WASH.: Seattle, 221 Third Ave.; WIS.: Milwaukee, 5215 Fond du Lac.

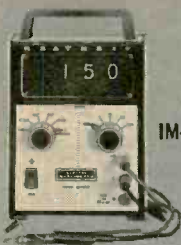

IM-1202



AA2010



GD-39



CP-1069



GR-271



AD-2022



Kit GR-110



GC-1005



IB-1100

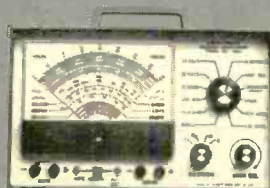

CM-1050



AD-530



TC-1160

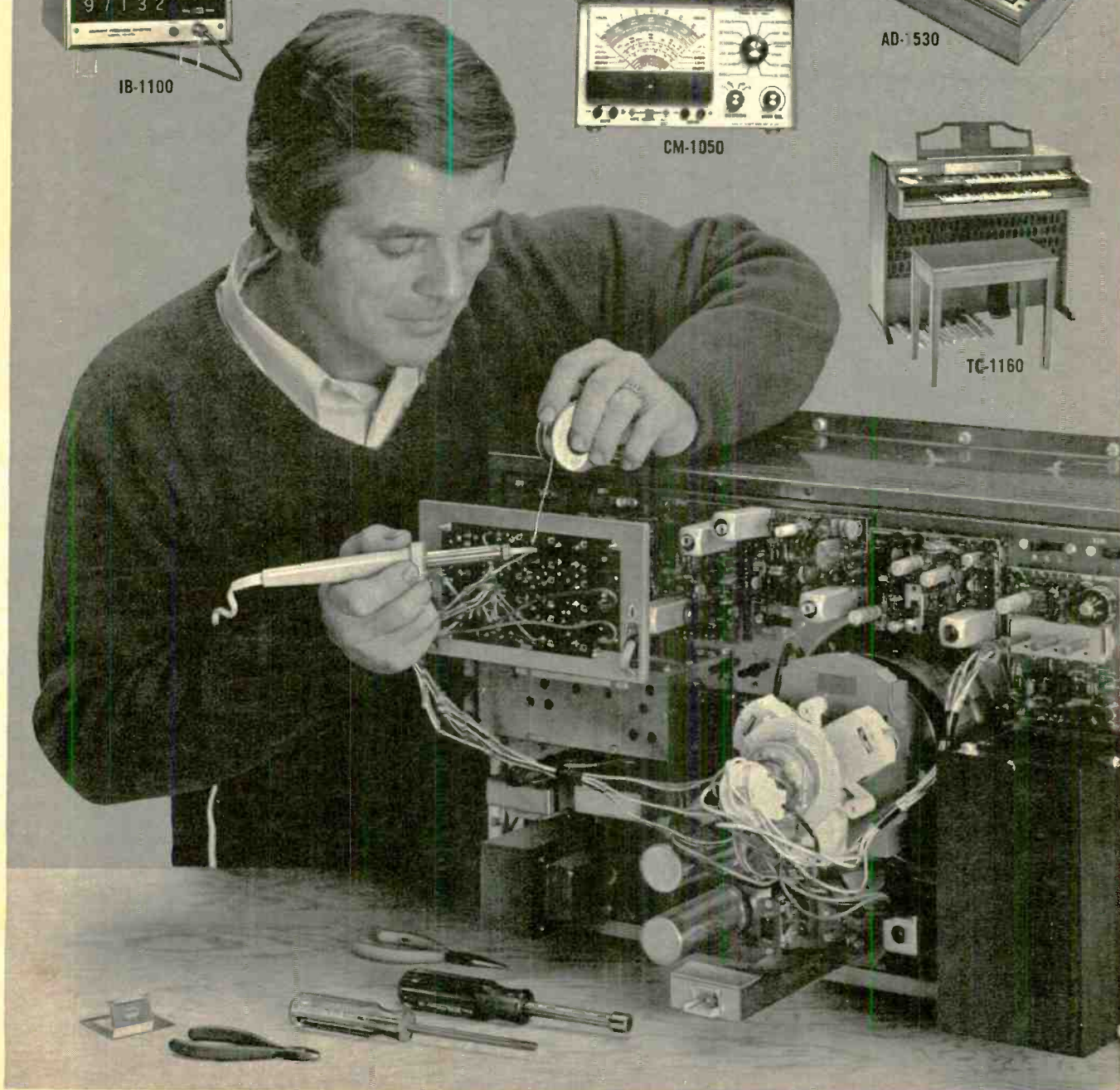

Circle 100 on reader service card

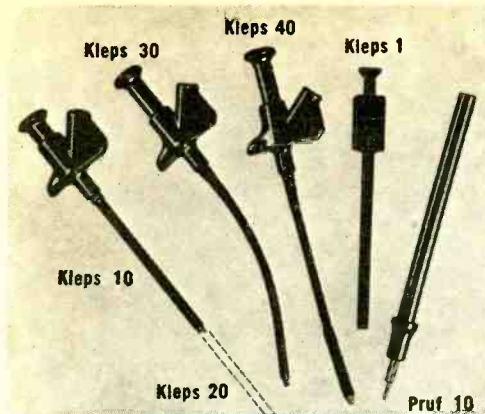

## Clever Kleps

Test probes designed by your needs—Push to seize, push to release (all Kleps spring loaded).

- Kleps 10.** Boathook clamp grips wires, lugs, terminals. Accepts banana plug or bare wire lead. 4 3/4" long. **\$1.19**
- Kleps 20.** Same, but 7" long. **\$1.39**
- Kleps 30.** Completely flexible. Forked-tongue gripper. Accepts banana plug or bare lead. 6" long. **\$1.47**
- Kleps 40.** Completely flexible. 3-segment automatic collet firmly grips wire ends, PC-board terminals, connector pins. Accepts banana plug or plain wire. 6 1/4" long. **\$2.39**
- Kleps 1.** Economy Kleps for light line work (not lab quality). Meshing claws. 4 1/2" long. **\$ .99**
- Pruf 10.** Versatile test prod. Solder connection. Molded phenolic. Doubles as scribing tool. "Bunch" pin fits banana jack. Phone tip. 5 1/2" long. **\$ .79**

All in red or black—specify. For additional information, write for complete catalog of—test probes, plugs, sockets, connectors, earphones, headsets, miniature components.



Available through your local distributor, or write to:

**RYE INDUSTRIES INC.**  
127 Spencer Place, Mamaroneck, N.Y. 10543  
In Canada: Rye Industries (Canada) Ltd.  
Circle 75 on reader service card



# new books

**MODERN RADIO REPAIR TECHNIQUES**, by Art Margolis. TAB Books, Blue Ridge Summit, Pa. 17214. 260 pp. 5 1/2" x 8 1/2". Hardcover, \$7.95; Softcover, \$4.95.

The seasoned TV technician gains considerably from the numerous troubleshooting tips in this book. Beginning technicians, with a few hours study, begin to turn out profitable work. The book reveals many simple shortcuts and test techniques for making radio repair a profitable sideline or even a profitable main line of business. It provides up-to-date service data on today's radio receivers, including AM, FM, FM stereo and multi-band plus a foldout section containing complete schematics for a dozen brand-name receivers. Directions on how to set up and equip a radio repair bench are included.

**BASIC COLOR TELEVISION COURSE**, by Stan Prentiss. TAB Books, Blue Ridge Summit, Pa. 17214. 420 pp. 5 1/2" x 8 1/2". Hardcover, \$9.95; Softcover, \$6.95.

A completely up-to-date textbook giving the beginning technician or student a thorough background in color and B&W television receiver basics. The text covers everything from the antenna to picture and sound. The book teaches how TV signals are "put together" at the broadcast station, radiated into the air and how these signals are picked up by a receiving antenna, sent to the receiver and reproduced; how colors are mixed and reproduced on a picture tube screen. All circuits are thoroughly discussed, including brand-new receiver circuits using transistors and integrated circuits and those used only for monochrome reproduction. Also covered are cable systems and major foreign TV systems.

**99 WAYS TO IMPROVE YOUR HI-FI**, by Len Buckwalter. Howard W. Sams & Co., Inc., 3 W. 57 St., New York, N.Y. 10019. 128 pp. 5 1/2" x 8 1/2". Softcover, \$3.50; In Canada, \$8.35.

# BUY RITE AND SAVE

## FREE \$1 BUY WITH EVERY 10 YOU ORDER

- TRANSISTOR RADIO *asst type* \$1.50  
good, bad, broken, as-is, potluck
- TAPE RECORDER—assorted types  
good, bad, broken, as-is, potluck **\$4**
- 300 — ASST. 1/2 WATT RESISTORS  
Top Brand, Short Leads, Excellent  
Selection **\$1**
- 100—ASST 1/4 WATT RESISTORS  
stand, choice ohmages, some in 5% **\$1**
- 100—ASST 1/2 WATT RESISTORS  
stand, choice ohmages, some in 5% **\$1**
- 70 — ASST 1 WATT RESISTORS  
stand, choice ohmages, some in 5% **\$1**
- 35 — ASST 2 WATT RESISTORS  
stand, choice ohmages, some in 5% **\$1**
- 50 — PRECISION RESISTORS  
asst. list-price \$50 less 98% **\$1**
- 20 — ASSORTED WIREWOUND  
RESISTORS, 5, 10, 20 watt **\$1**
- 10—ASSORTED SLIDE SWITCHES  
SPST, SPDT, DPDT, etc. **\$1**
- 2 — COLORBURST QUARTZ.  
CRYSTAL For Most Color TV  
sets 3579,545 KC **\$1.89**
- 2 — ELECTROLYTIC CAPACI-  
TORS CD — 40/40 MFD — 450  
Volts **\$1**
- SPECIAL TUBE BUY  
4 — 18FV6 American made **\$1**
- 1—6" x 9" HEAVY DUTY 10 OZ.  
SPEAKER Ceramic Type **\$3.95**  
8 Ohm
- 5 ASSTD. GLOBAL VARISISTOR  
Popular replacements for most  
COLOR TV **\$1**
- 10 — SETS PHONO PLUGS &  
PIN JACKS RCA type **\$1**
- 8—PRINTED CIRCUIT IF TRANS-  
FORMERS 4-Lug, 456 KC **\$1**
- 25 — 3900-OHM-7w RESISTOR  
10% Corning glass **\$1**
- 20 — 47-600V CONDENSERS  
White Ceramic C.D.—American **\$1**
- STEREO TONE ARMS Most popu-  
lar type—turn over cartridge **\$2**
- CO-AX CABLE RG59U grey or  
black 250'—\$9 100'—\$3.69 50'—  
**\$2**
- 4 — TV ALIGNMENT TOOLS **\$1**  
most useful assortment #1
- 4 — TV ALIGNMENT TOOLS **\$1.49**  
For Color TV #2
- 6 — TV COLOR ALIGNMENT **\$2.79**  
TOOLS Most popular type
- 5 — 9 VOLT MOTORS Excellent **\$1**  
for hobbyist
- 200' — #24 SOLID PUSH BACK  
WIRE Yellow or Black excellent  
buy **\$1**
- UNIVERSAL TV ANTENNA  
Back of set mounting **\$1.98**  
5 section rods

**KNOB SPECIAL**

- 100 — ASSORTED RADIO  
KNOBS All standard types **\$1**  
\$20 value
- 50 — TV KNOBS — POPULAR  
TYPES Mostly Selector & Fine  
Tuning **\$1**
- 25 — VERTICAL LINEARITY  
KNOBS Long shank . . . Front  
mount . . . miniature assortment **\$1**
- 20 — VERTICAL LINEARITY  
KNOBS . . . Side mount **\$1**  
Standard sizes
- 25—KNURLED RADIO KNOBS **\$1**  
Hard to get . . . Best selection
- 40 — DELUXE RADIO KNOBS  
Choice assortment . . . Popular  
types **\$1**

**ANY 6 KITS FOR \$5**

## FREE GIFT WITH EVERY ORDER

- 12" UNIVERSAL SPEAKER **\$4.89**  
Top Quality . . . Large Magnet
- 10" PHILCO SPEAKER **\$2.99**  
Top Quality . . . Large Magnet
- 8" UNIVERSAL SPEAKER — **\$2.99**  
Large Magnet—Special Buy
- 5" UNIVERSAL TWEETER **\$1.25**  
1 Oz. Magnet
- UNIVERSAL 4" PM SPEAKER **\$1**  
Top Quality
- 2 1/2" x 4" SPEAKER **69¢ Ea.**  
Special Buy 10 For \$5—
- 4" X 6" "QUAM" 16 OHM  
SPEAKER Large magnet **\$1.79**  
Special BUY (10 for \$15.00)
- RONETTE STEREO CARTRIDGE **\$2**  
latest dual sapphire slipover type
- STEREO HEADPHONES  
Hi-Fi Quality . . . Complete **\$5.95**  
with Stereo plug
- COLOR POWER TRANSFORMER  
— Good for most sets 26R150 **\$6.95**  
List Price—\$36.75
- 4-50' HANKS HOOK-UP WIRE **\$1**  
assorted colors
- 100'—SPOOL SPEAKER WIRE **\$1.50**  
2 cond, mini zip, clear, 101 uses
- 10 — ASST. RADIO & TV TUBES **\$1**  
Every Tube a good number
- 5 — AUDIO OUTPUT TRANS-  
FORM Sub-min for Trans Radios **\$1**
- 5 — I.F. COIL TRANSFORMERS **\$1**  
456-kc for Transistor Radios
- 6" UNIVERSAL SPEAKER  
Top quality Special buy **\$1.29 Ea.**  
5 for \$5
- ALL AMERICAN TUBE KIT **\$2.99**  
(12AV6-12BE6-12BA6-35W4-50C5)
- 70° COLOR TUBE BRIGHTNER **\$3.95**
- 90° COLOR TUBE BRIGHTNER **\$4.95**
- UHF TUNER — TRANSISTOR **\$3.95**  
TYPE Used in all TV sets
- STANDARD TUNER — TRANSIS-  
TOR (GUIDED GRID) **\$1**  
4 Channel closed circuit
- PHILCO TV TUNERS  
Model—76-13983-3 (5GJ7— **\$4.95**  
3HQ5)
- GE — TV TUNERS **\$5.95**  
Model-ET 86X314 - (5LJ8-3GK5)
- GE — STANDARD COIL TV  
TUNER  
Model EU-S6XI (6HQ5—6GJ7) **\$7.95**  
Model-ET 86X304 — (6LJ8—  
6HA5)
- TV TUNERS VHF/UHF all new **\$7.95**  
standard makes, including Tubes
- TV TUNER — asst. all new **\$1**  
standard makes, Less tubes

**SARKES TARZIAN TUNER**  
41mc

Latest Compact  
Model good for  
all 41 mc TV's.  
**BRAND NEW—**

Best TUNER "SARKES TAR-  
ZIAN" ever made—last word for  
stability, definition & smoothness  
of operation. An opportunity—to  
improve and bring your TV Re-  
ceiver up-to-date. **\$7.95**  
COMPLETE with Tubes

IMMEDIATE DELIVERY . . . Scientific light packing for safe delivery at minimum cost.  
HANDY WAY TO ORDER: Pencil mark or write amounts wanted in each box, place letter  
F in box for Free \$1 BUY. Enclose with check or money order, add extra for shipping.  
Tear sheets will be returned as packing slips in your order, plus lists of new offers.  
**Minimum Order \$3.00**

Please specify refund on shipping overpayment desired:  CHECK  POSTAGE STAMPS  MERCHANDISE (our choice) with advantage to customer

**BROOKS RADIO & TV CORP., 487 Columbus Ave., New York, N. Y. 10024** 212-874 5600  
96 RADIO-ELECTRONICS • FEBRUARY 1973 TELEPHONE

Name .....

Address .....

Cost of goods .....

Shipping .....

estimated .....

TOTAL .....

# Free! 1973 Eico Catalog

OVER 200 INSTRUMENTS • KIT & WIRED!

NEW! TR-410 Solid State Triggered Sweep Scope  
 NEW! 300C "Clamp-On" Current Tester  
 NEW! TD-8 8 Track Stereo Tape Deck  
 NEW! SS-200 "Time Delay" Burglar Alarm System  
 NEW! ASA-300 Electronic Siren Auto Alarm

Build all-professional Eico Kits and save up to 50%. The more you know about electronics, the more you'll appreciate Eico. Over 2500 local Eico dealers offer you all the top brands, personal technical counsel, fast off-the-shelf service. Free catalog includes Test Equipment, Stereo, Eico-craft Projects, Burglar/Fire Alarm Systems and name of nearest Eico distributor, check reader service card or send 25¢ for first class mail service.

EICO, 283 Malta St., Brooklyn, N.Y. 11207  
 Leadership in creative electronics since 1945



All inclusive coverage on methods for improving your hi-fi and stereo sound systems. Many items are simple adjustments that can be performed at little or no cost. Only very basic technical knowledge or none at all is required to follow the instructions and no special tools are required. Some of the topics covered are installation of the hi-fi, FM stereo reception, phonos and turntables, amplifiers, tape equipment, speakers, stereo headphones and microphones, accessories, and troubleshooting tips.

**101 QUESTIONS & ANSWERS ABOUT AM, FM, & SSB**, by Leo G. Sands. Howard W. Sams & Co., Inc., 3 W. 57 St., New York, N.Y. 10019. 96 pp. 5 1/2" x 8 1/2". Softcover, \$3.95; In Canada, \$4.95.

Questions and answers covering both the history and basic technical aspects of the three types of modulation as well as receivers that are used for demodulation. Divided into three parts, the guide contains material concerning the advantages and disadvantages of each modulation and demodulation method as well as the basic circuits employed in the process. Examples of questions answered are what is a noise blanker, why do most mobile stations use FM, and how is SSB used in telephone systems.

**PRACTICAL SOLID-STATE PRINCIPLES & PROJECTS**, by Ken Sessions. TAB Books, Blue Ridge Summit, Pa. 17214. 176 pp. 5 1/2" x 8 1/2". Hardcover, \$6.95; Softcover, \$3.95.

A project-oriented approach to learning about the latest semiconductor devices and circuits anyone can understand and build; projects such as an electronic burglar alarm, a solid-state timer, a metronome, an automatic night light switch. Fifty-two unique projects, some with multiple applications, include Citizens band receiver, stereo amplifier, integrated circuit code-practice tone oscillator, battery charger, precision tachometer and many more practical projects. R-E

Circle 76 on reader service card

### SHANNON MYLAR RECORDING TAPE

3"	- 225'	.. .19	CASSETTE C-60	..... .59
3 1/4"	- 600'	.. .58	CASSETTE C-90	..... 1.00
5"	- 600'	.. .62	CASSETTE C-120 (TDK)	1.97
5"	- 900'	.. .80	8 - Track - 64 Min.	- 1.29
5"	- 1200'	.. .97	8 - Track - 80 Min.	- 1.59
5"	- 1800'	.. 1.49	8 - Track - Cleaner	- 1.49
7"	- 1200'	.. .77		
7"	- 1800'	.. 1.12	3" TAPE REEL	.... .06
7"	- 2400'	.. 1.79	3 1/4" TAPE REEL	.... .07
7"	- 3600'	.. 2.95	5" TAPE REEL	.... .14
			7" TAPE REEL	.... .18

### CANADIANS: Ordering is easy - we do the paperwork - try a small order

## WESTINGHOUSE ALL TRANSISTOR HOME/OFFICE MESSAGE CENTER

Leaves messages for other for replay... Built in speaker/microphone for talk-into convenience... Records up to 3 minutes of messages... Illuminated signal shows when a message is waiting. Control adjusts playback volume without affecting recording volume... Capstan Drive;  
**BRAND NEW SOLD AS IS \$7.95**

### IBM COMPUTER SECTIONS

8 assorted Units we sell for \$1 are loaded with over 150 valuable parts.

Incl. — Transistors, Condensers, Resistors, Heat Sinks, Diodes, Etc.

**8 for \$1**  
**100 for \$10**



### RCA 110° FLYBACK TRANSFORMER

We scooped the Market Latest type - standard for all 110° TV's RCA's design of large Coil produces 18KV - assuring adequate width Incl Schematic Diagram application for any TV List price \$13.90

Your price .. \$3  
 10% off in lots of 3

110° TV DEFLECTION YOKE for all types TV's Incl schematic **\$3.95**

"COMBINATION SPECIAL" RCA 110° FLYBACK plus 110° DEFLECTION YOKE **\$5.95**

90° FLYBACK TRANSFORMER for all type TV's Incl schematic **\$2.95**

90° TV DEFLECTION YOKE for all type TV's Incl schematic **\$2.95**

70° FLYBACK TRANSFORMER for all type TV's Incl schematic **\$2**

70° TV DEFLECTION YOKE for all type TV's Incl schematic **\$2**

SHARP 110° FLYBACK & YOKE COMBINATION #8FT-592 Good for most portable TV. **\$5.00**

90° COLOR YOKE For all Rectangular 19 to 25" Color CRT's **\$10.95**

RCA COLOR FLYBACK Part #113382 (Stancor #HO-601C) **\$12.95**

### MARKET SCOOP COLUMN

SIMPSON 2 1/2" ROUND PANEL METERS Model 125 (0-100 DC Milliammeters) **\$3.95**

SIMPSON 2 1/2" ROUND PANEL METERS Model 125 (0-10 DC Milliammeters) **\$3.95**

ASTATIC PICKUP MODEL 700-89T Contains 89T ceramic cartridge LIST PRICE \$17.00 **\$2.95**

20 - DIPPED MYLAR CAPACITORS .01-800V **\$1**

20 - DIPPED MYLAR CAPACITORS .033-800V **\$1**

20 - DIPPED MYLAR CAPACITORS .0033-1000 V **\$1**

20 - DIPPED MYLAR CAPACITORS .047-400 V **\$1**

15 - MOLDED TUBULAR CAPACITORS .068-400 V **\$1**

20 - DIPPED MYLAR CONDENSERS .0039-400 V **\$1**

10 - SPRAGUE "ORANGE DROP" CAPACITORS .0056-2000 Volt **\$1**

1 - 20 FT. COILED GUITAR CABLE With plugs **\$2.95**

1-CASSETTE TYPE DYNAMIC MICROPHONE with universal plugs-200 Ohms **\$2.49**

COLOR CONVERGENCE ASSEMBLY Universal type- good for most sets **\$2.49**

UTAH "CELESTA" 3-WAY CO-AX SPEAKERS 8"-10oz. Mag.-30 Watts **\$16.95**

UTAH "CELESTA" 3-WAY CO-AX SPEAKERS 12"-20oz. Mag.-45 Watts **\$24.95**

COLOR-TV RECTIFIER - Used in most color sets- 6500 kv **\$1.99**

10 - STANDARD TRANSISTORS NPN & PNP 2N404, 2N414, etc. **\$1**

10-ASSORTED DIODE CRYSTALS 1N34, 1N48, 1N60, 1N64, etc. **\$1**

6 - TOP BRAND SILICON RECTIFIERS 1 amp. 1000 PIV **\$1**

5 - PNP TRANSISTOR general purpose, TO-5 case **\$1**

5 - NPN TRANSISTORS general purpose, TO-5 case **\$1**

50 - ASSORTED TRANSISTORS big factory scoop - sold as-is **\$1**

TV TWIN LEAD-IN 300 ohm 500' - \$7 100' - \$1.80 50' **\$1**

12-MINIATURE ELECTROLYTIC CONDENSERS For Transistor & miniature work **\$1**

6 - MINIATURE ELECTROLYTIC CAPACITORS 5 MFD-150 V **\$1**

3-ELECTROLYTIC CONDENSERS 100 mfd.-100 V, 50 mfd.-75 V **\$1**

2-ELECTROLYTIC CONDENSERS C.D. 500 mfd-200 volts **\$1**

2-ELECTROLYTIC CONDENSERS UNENAP ... 2000/1000 Mfd 30 Volt **\$1**

2 - ELECTROLYTIC CONDENSERS 80/50mfd-450V, 20mfd-250V, 150mfd-25V **\$1**

2 - ELECTROLYTIC CONDENSERS 200/30/4 mfd - 350V **\$1**

HEAVY DUTY COLOR FOCUS RECTIFIER 14,000 PIV @ 1 MA. **\$1**

WESTINGHOUSE FM TUNER (12DT8 Tube) **\$2.99**

WESTINGHOUSE FM TUNER #478-V-015D01 Transistor **\$3.99**

300 - ASSORTED HEX NUTS 2/56, 4/40, 5/40, 6/32, 8/32 **\$1**

250 - ASST. SOLDERING LUGS best types and sizes **\$1**

250 - ASST. WOOD SCREWS finest popular selection **\$1**

250 - ASST. SELF TAPPING SCREWS #6, #8, etc. **\$1**

150 - ASST. 6/32 SCREWS and 150 6/32 HEX NUTS **\$1**

150 - ASST. 8/32 SCREWS and 150-8/32 HEX NUTS **\$1**

150 - ASST. 2/56 SCREWS and 150-2/56 HEX NUTS **\$1**

150 - ASST. 4/40 SCREWS and 150-4/40 HEX NUTS **\$1**

150 - ASST. 5/40 SCREWS and 150-5/40 HEX NUTS **\$1**

500 - ASSORTED RIVETS most useful selected sizes **\$1**

300 - ASSORTED WASHERS most useful selected sizes **\$1**

100 - ASST. RUBBER BUMPERS for cabinet bottoms & other uses **\$1**

100-ASSORTED RUBBER GROMMETS best sizes **\$1**

Circle 77 on reader service card

Pioneering again....Castle presents a sensational NEW Timesaver for the Professional TV Service Technician.....

# TV TUNER SUBBER™



Transistorized Test Unit substitutes the tuner in defective TV Receiver to prove whether original tuner is good or bad. Performs tests normally made using elaborate and expensive signal generating equipment and oscilloscopes... but much more simply, with easily understood results. Tests that are, in fact, so simple that they can be made right in the home, in most cases without removing the tuner or chassis from cabinet.

Use with any 40MHz receiver... block and white... or color... tube or transistor.

Completely self contained and battery operated; Mk. II, all solid state, improved version of original "subber." Uses L.E.D. indicator, has higher gain with wide range control affording more than 40db of gain reduction. Use on the bench or in the home... anywhere.

Substitutes the VHF tuner and tests the UHF tuner. Provides signal to simplify testing of tuner, i.f. system and AGC system. Comes complete with extension cables and instructions.

**TV TUNER SUBBER MK. II net \$31.95** Contact your distributor.

Include \$1.50 shipping and handling on prepaid mail orders; we will ship C.O.D.



**CASTLE TV TUNER SERVICE, INC.**

5715 N. Western Ave., Chicago, Illinois 60645 • Phone (312) - 561-6354  
Circle 78 on reader service card

## Accuracy like a VTVM... Convenience like a VOM...

NEW BATTERY-OPERATED FET  
SOLID-STATE VOLT-OHMMETER #116

Easy-to-build KIT

**\$30.90** =116K

Factory-Wired & Tested

**\$42.90** =116W

Now you can get all the benefits of a VTVM (laboratory accuracy, stability and wide range) but with its drawbacks gone: no plugging into an AC outlet, no waiting for warm-up, no bulkiness. New Field Effect Transistor (FET) design makes possible low loading, instant-on battery-operation and small size. Excellent for both bench and field work.

Compare these valuable features:

- High impedance low loading: 11 megohms input or DC, 1 megohm on AC
- 500-times more sensitive than a standard 20,000 ohms-per-volt VOM
- Wide-range versatility: 4 P-P AC voltage ranges: 0-3.3, 33, 330, 1200V; 4 RMS AC voltage ranges: 0-1.2, 12, 120, 1200V; 4 DC voltage ranges: 0-1.2, 12, 120, 1200V; 4 Resistance ranges: 0-1K, 0-100K, 0-10 meg., 0-1000 meg.; 4DB ranges: -24 to +56DB.

Sensitive easy-to-read 4½" 200 micro-amp meter. Zero center position available. Comprises FET transistor, 4 silicon transistors, 2 diodes. Meter and transistors protected against burnout. Etched panel for durability. High-impact bakelite case with handle useable as instrument stand. Kit has simplified step-by-step assembly instructions. Both kit and factory-wired versions shipped complete with batteries and test leads. 5¼"H x 6¾"W x 2⅞"D. 3 lbs.

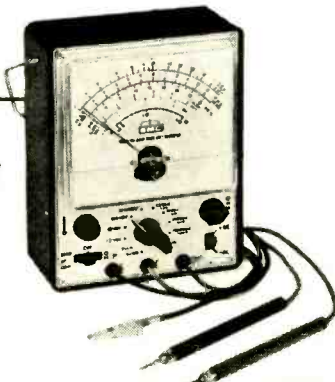

Send FREE catalog of complete EMC line and name of nearest distributor. RE-2

Name \_\_\_\_\_

Address \_\_\_\_\_

City \_\_\_\_\_

State \_\_\_\_\_ Zip \_\_\_\_\_

# EMC

ELECTRONIC MEASUREMENTS CORP.  
625 Broadway, New York, N.Y. 10012

# circuits

## TOUCH OR PROXIMITY SWITCH

This circuit can be adjusted to switch when a human body approaches to within a few inches of an insulated detector plate. Thus, it can be used as an electrically isolated touch switch or a part of an intruder alarm. The design was credited to International General Electric Co. of New York in *Electronic Engineering* magazine.

The PUT (programmable unijunction transistor) turns on when its anode voltage exceeds the gate voltage by about 0.5 volt. Its anode voltage is held constant at the

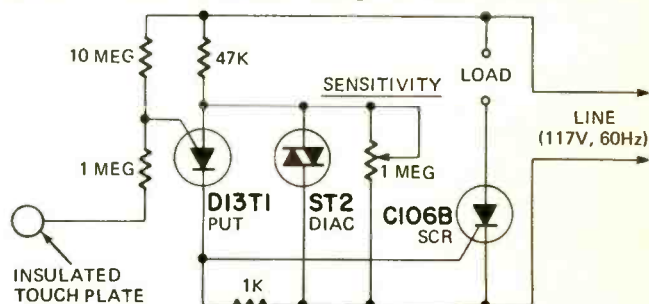

"on" voltage of the diac. A body approaching the detector plate changes the capacitance between the plate and ground. This change in capacitance causes a shift in the phase angle between the PUT's anode and gate voltages. The phase angle widens until, at some time, the voltage difference is high enough to fire the PUT. The voltage developed across the 1000-ohm resistor fires the SCR used as the solid-state relay controlling the load. The SENSITIVITY control determines the voltage level at which the PUT's anode is clamped.

## MOBILE POWER SUPPLY FOR CASSETTE RECORDER

Quite a few business men use a cassette recorder in their cars for recording dictation, keeping records, etc. These recorders get fairly heavy use and the batteries seem to go dead just when the driver is many miles away from a store where replacement batteries are available.

The diagram shows a simple regulated supply for op-

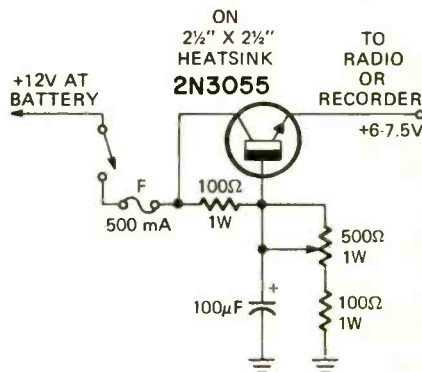

erating 6-7.5-volt portable radios and cassette recorders from the car's 12-volt battery. The circuit is adapted from *Radio Electronica* (Netherlands). The 2N3055 transistor should be mounted on a good heatsink at least 2½ inches square. The heatsink and case of the transistor must be insulated from ground and possible contact with the body of the car. Use the 500-ohm pot or adjustable resistor to set the output voltage to the desired level.

THE ONE WORD  
FOR PERFORMANCE  
AND RELIABILITY IN  
ELECTRONIC IGNITION

JUDSON

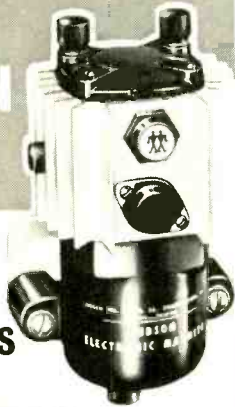

YOU  
CAN HAVE  
TOMORROW'S  
IGNITION ON  
YOUR CAR TODAY

Proven by over 100,000 in operation  
for over five years.

Don't accept "as good as" there are  
none.

Write Today for Literature

**JUDSON**  
RESEARCH AND MFG. CO.   
CONSHOHOCKEN PA. 19428

Circle 79 on reader service card

**FREE** catalog



over  
**1000**  
unique tools,  
handy kits,  
precision  
instruments,  
technical  
supplies.

Our 20th year of service to the World's  
finest craftsmen and technicians.

 **National Camera**  
2000 West Union Ave. Dept. G88  
Englewood, Colorado, 80110

Send a FREE copy of the nc Flasher

name \_\_\_\_\_

address \_\_\_\_\_

city \_\_\_\_\_

state \_\_\_\_\_

zip \_\_\_\_\_

 **National Camera**  
2000 West Union Ave. Dept. G88  
Englewood, Colorado, 80110

Circle 80 on reader service card

### DIRECT-READING CAPACITANCE METER

The average technician's or experimenter's workbench is equipped for nearly any type of test or operation imaginable except for quick capacitance measurements. The diagram shows a simple capacitance meter for measuring capacitance from 1 microfarad down to a few picofarads. (G3XGP called it "The Puffmeter" when he described it in *Radio Communication*.)

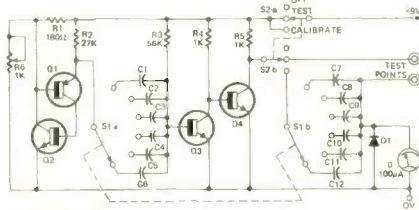

TRANSISTORS SEE TEXT  
C1, 7 - 100pF C4, 10 - 1,000pF  
C2, 8 - 0.01pF C5, 11 - 100pF  
C3, 9 - 0.01pF C6, 12 - 10pF

Transistors Q1 and Q2 along with R1, R2, potentiometer R3, the capacitor selected by S1-a and the base-emitter junction of Q3 form a regenerative-type ramp generator. The sawtooth-like ramp voltage is converted to a square wave by Q3 and Q4 and fed through the unknown capacitor or one of the standard capacitors (C7 through C12). The capacitor and diode D1 convert the square wave to a sharp positive pulse whose amplitude is determined solely by the value of the capacitor. The diode current is related to frequency and capacitor value. The meter integrates these values. If the FREQUENCY control is varied so the meter reads fullscale on any range with a standard capacitor, the unknown produces a reading in direct proportion.

Q1 must be a high-gain pnp transistor such as a 2N4125 or 2N4288. Q2 is an npn device such as a 2N3493 or a low-gain 2N706. Q3 and Q4 may be a 2N706 or any small-signal npn transistor.

To use the capacitance meter, connect the unknown capacitor across the test terminals. Throw S2 to CALIBRATE and move switch S1 to the range of the probable value of the unknown. Rotate pot R6 for a fullscale reading on the meter. Throw S2 to TEST. The meter now reads in direct proportion to the value of the standard capacitor.

Accuracy of the instrument depends on the precision of the standard capacitors (C7 through C12). You can purchase one precision-1% or better-capacitor and use it as a standard when hand-picking the others from ordinary stock. For example, suppose that for C10 (1000 pF or .001 μF) you have a 1% or better tolerance device

(continued on page 104)

## Reduce Car Maintenance Increase Engine Performance.

Put a Mark Ten Capacitive  
Discharge Ignition (CDI)  
System On Your Car.

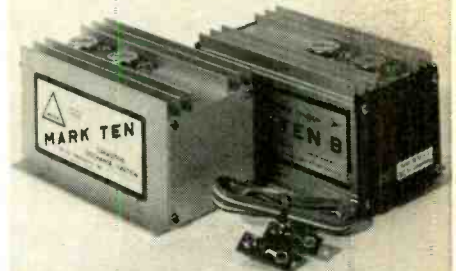

Even Detroit finally recognizes that electronic ignition systems dramatically increase engine performance. Chrysler is now putting them on their new models. The Mark Ten CDI, the original electronic ignition system, has been giving increased performance with lower maintenance to hundreds of thousands of satisfied customers for over eight years. Install a Mark Ten CDI on your car, boat or truck and eliminate 3 out of 4 tune-ups. Increase gasoline mileage up to 20%. Enjoy improved engine performance. Or put a Mark Ten B on your car. It was especially designed for engines with smog control devices. By reducing combustion contaminants, the Mark Ten B restores power losses caused by these devices. Equipped with a convenient switch for instant return to standard ignition, the Mark Ten B is applicable to ANY 12 volt negative ground engine. Both systems install in 10 minutes with no rewiring. Order a Mark Ten or Mark Ten B CDI today.

Mark Ten (Assembled) \$44.95 ppd.  
Mark Ten (DeltaKit) \$29.95 ppd.  
(Kit available in 12 volt only,  
positive or negative ground.)  
Mark Ten B \$59.95 ppd.  
(12 volt negative ground only)  
Superior Products at Sensible Prices  
Mfg. in U.S.A.



Dept. RE  
**DELTA PRODUCTS, INC.**

P.O. Box 1147/Grand Junction, Colo. 81501  
(303) 242-9000

Please send me free literature.

Enclosed is \$ \_\_\_\_\_  Ship ppd.  Ship C.O.D.

Please send:

\_\_\_\_\_ Mark Ten B @ \$59.95 ppd.

\_\_\_\_\_ Standard Mark Ten (Assembled)  
@ \$44.95 ppd.

\_\_\_\_\_ 6 Volt: Neg. Ground Only

\_\_\_\_\_ 12 Volt: Specify

\_\_\_\_\_ Positive Ground \_\_\_\_\_ Negative Ground

\_\_\_\_\_ Standard Mark Ten (DeltaKit) @  
\$29.95 ppd.

(12 Volt Positive Or Negative Ground Only)

Car Year \_\_\_\_\_ Make \_\_\_\_\_

Name \_\_\_\_\_

Address \_\_\_\_\_

City/State \_\_\_\_\_ Zip \_\_\_\_\_

Circle 81 on reader service card

# YOU CAN BUILD ANY CIRCUIT IN 3 EASY STEPS

## WITH THIS FREE VEROBOARD SAMPLE



Veroboard is the universal wiring board that eliminates the need for etching, wires, or terminals — the circuitry is built right into the board! It is the simplest, fastest method of circuit building for the technician, engineer, hobbyist or experimenter. Send for your free sample now and we'll send you our brochure, "Everything you want to know about Veroboard."



**VERO ELECTRONICS, INC.**  
171 BRIDGE ROAD, HAUPPAUGE, N.Y. 11787

Circle 82 on reader service card

# next month

MARCH 1973

This stereo spectacular issue is crammed with high-fidelity articles of all kinds.

- **Build A Four-Channel Power Amplifier**  
Each channel delivers 60-watts sine-wave continuous output into an 8-ohm load with less than 0.01% IM. It's a real powerhouse.

- **4-Channel Tape For Your Car**  
A survey of what's available and in what configurations. A story you must read before buying an add-on tape system.

- **Off-Beat 4-Channel Speaker Systems**  
Flat styrafoam, acoustic transducers, pictures, balls, cubes, lamps columns—they're all speaker systems you should know more about.

- **Tape Bias And Magnetic Recording**  
How much effect does the bias have? We tell you and show you with a set of scope pictures. You may not believe the results.

**PLUS:**  
State-Of-Solid State  
Plug-In-Stopwatch  
Step-By-Step Troubleshooting

We were unable to kick off the Semiconductor Interchangeability Directory in this issue because of last minute delays in verifying the data. Rather than take a chance on unnecessary errors we decided to delay presenting the first section until the March issue.



## MISSILE BATTERY

The Only  
Lifetime Battery

Surplus—Ni-Cad plastic sintered-plate battery cells at approx. 10% of government cost

Connect these 1.2 V. cells in series to make batteries of any voltage. (Example: 10 cells = 12 V. Batt.), or size to replace storage batteries on autos, motor-cycles, boats, radio, etc. All the good characteristics not possessed by lead-acid and other alkaline batteries such as: Lifetime service, lighter wgt., constant voltage, high discharge rate (approx. 10 times AH cap.), operate at 100% cap. in temp. range —65° to +165°F., not harmed by storage, discharge, overcharge, or freezing. May be charged thousands of times with the only maintenance of adding distilled water and keeping clean. Select cell sizes to fit your application below.

Esse Type	AMP Hr	Dimensions Inches			Wgt. Oz.	Cost
		High	Width	Deep		
AH4	4	6	2	1/2	6	1.49
AH4	4	6	2	1/2	6	*2.95
AH6S	6	4	2-1/8	15/16	8	1.79
AH6	6	4-5/8	2-5/8	3/4	8	1.79
AH6	6	4-5/8	2-5/8	3/4	8	*2.95
AH10	10	4-3/4	2-3/4	1-3/16	16	2.29
AH10	10	4-3/4	2-3/4	1-3/16	16	*4.95
AH12	12	5-3/4	2-5/16	1-1/16	18	2.79
AH15	15	7	2-3/8	1-1/16	18	3.49
AH20	20	5-1/2	3-1/8	1-5/8	30	7.95
AH34	34	9-1/4	3-1/8	1-3/8	52	8.95

\*New

### SPECIAL CLOSE OUT!

Metal cased Ni-Cad cells, ideal for motor starting.  
30AHM-30AH, 8-7/8x3x1-1/4, Wgt. 3-1/2 lbs. \$2.00  
52AHM-52AH, 9x3x1-5/8, Wgt. 4-1/2 lbs. ... \$3.50  
Send for complete list including made-up batteries.  
All cells guaranteed for satisfaction or money back.  
All cells not marked new are used but serviceable.  
Include postage on parcel post shipments.

**ESSE RADIO COMPANY**

Dept. RE-2  
369 S. Meridian St.  
Indianapolis, Ind. 46225

For  
faster  
service

USE  
ZIP  
CODE

on  
all  
mail

Circle 83 on reader service card



# IMPOSSIBLE? BARGAINS IN SURPLUS ELECTRONICS AND OPTICS

## NEW - COSMOS INTEGRATED CIRCUIT

Said to be the "New Wave" in integrated circuits of the future. Ultra low power drain (microwatts)

<input type="checkbox"/> 4000AE	Dual 3 Input Nor & Inv	\$ .99
<input type="checkbox"/> 4001AE	Quad 2 Input Nor	\$ .99
<input type="checkbox"/> 4002AE	Dual 4 Input Nor	\$ .99
<input type="checkbox"/> 4006AE	18 Stage Static Shift Register	\$4.99
<input type="checkbox"/> 4007AE	Dual Complementary Pair & Inv	\$ .99
<input type="checkbox"/> 4009AE	Hex Buffer, Inverting	\$2.19
<input type="checkbox"/> 4010AE	Hex Buffer Non Inverting	\$2.19
<input type="checkbox"/> 4011AE	Quad 2 Input Nand	\$ .99
<input type="checkbox"/> 4012AE	Dual 4 Input Nand	\$ .99
<input type="checkbox"/> 4013AE	Dual "D" Flip Flop	\$1.99
<input type="checkbox"/> 4014AE	8 Stage Static Shift Register	\$5.99
<input type="checkbox"/> 4015AE	Dual 4 Stage Static Shift Register	\$5.99
<input type="checkbox"/> 4016AE	Quad Bilateral Switch	\$1.99
<input type="checkbox"/> 4017AE	Decade Counter W/Decoder	\$5.99
<input type="checkbox"/> 4018AE	Pre-settable Divide by "N" Counter	\$5.99
<input type="checkbox"/> 4019AE	Quad and/or Select Gate	\$2.39
<input type="checkbox"/> 4020AE	14 Stage Binary Ripple Counter	\$5.99
<input type="checkbox"/> 4021AE	8 Stage Static Shift Register	\$5.49
<input type="checkbox"/> 4022AE	Octal Counter W/Decoder	\$5.19
<input type="checkbox"/> 4023AE	Triple 3 Input Nand	\$ .99
<input type="checkbox"/> 4024AE	7 Stage Counter	\$3.99
<input type="checkbox"/> 4025AE	Triple 3 Input Nor	\$ .99
<input type="checkbox"/> 4026AE	Decade Counter/7 Segment Decoder	\$7.49
<input type="checkbox"/> 4027AE	Dual J-K Flip Flop	\$2.99
<input type="checkbox"/> 4029AE	Pre-settable Up/Down Counter	\$7.99
<input type="checkbox"/> 4030AE	Quad Exclusive Or	\$1.99
<input type="checkbox"/> 4033AE	Decade Counter/7 Segment Decoder	\$7.49

## SPECTRA - STRIP FLAT BONDED



We know this is what everyone wants for their home-brew projects, because they always ask for it. We now have over 5 by 10" feet, but it won't last long, so order now before it's all gone. We don't want any broken hearts. Specs: 20 conductors, 24 AWG, 7 strands, size is .88" x .044". We could give all its virtues, but most people know them or could easily look it up in any industrial electronics house catalogue.

Sh. Wt. 1lb./10 feet	Order No. SSFBR3 (ft.)	
<input type="checkbox"/> \$ 35/1 ft.	<input type="checkbox"/> \$ 1.00/3 ft.	<input type="checkbox"/> \$ 5.00/18 ft.
<input type="checkbox"/> \$30.00/100 ft.	<input type="checkbox"/> \$ 55.00/200 ft.	<input type="checkbox"/> \$100.00/400 ft.
<input type="checkbox"/> \$200.00/900 ft.	<input type="checkbox"/> \$500.00/2000 ft.	

## SANKEN HYBRID AUDIO AMPLIFIER MODULES

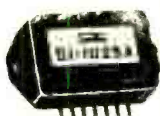

We have made a fortunate purchase of Sanken Audio Amplifier Hybrid Modules. With these you can build your own audio amplifiers at less than the price of discrete components. Just add a power supply, and a chassis to act as a heat sink. Brand new units, in original boxes, guaranteed by B and F, Sanken, and the Sanken U.S. distributor. Available in three sizes: 10 watts RMS (20 watts music power), 25 watts RMS (50 watts M.P.), and 50 watts RMS (100 watts M.P.) per channel. Twenty-page manufacturer's instruction book included. Sanken amplifiers have proved so simple and reliable that they are being used for industrial applications, such as servo amplifiers & wide band laboratory application.

<input type="checkbox"/> S11010Y	10 watts RMS amplifier, industrial grade	\$ 4.75
<input type="checkbox"/> S11025A	25 watt RMS amplifier, industrial grade	\$14.75
<input type="checkbox"/> S11050A	50 watt RMS amplifier, industrial grade	\$22.50
<input type="checkbox"/> S11025E	25 watt RMS amplifier, economy grade	\$14.00
<input type="checkbox"/> S11050E	50 watt RMS amplifier, economy grade	\$21.00
<input type="checkbox"/>	Transformer for stereo 10-watt amplifiers (2 lbs.)	\$ 3.95
<input type="checkbox"/>	Transformer for stereo 25 or 50 watt amplifiers (5 lbs.)	\$ 5.95
<input type="checkbox"/>	Set of (3) 2000 mfd 50V capacitors for 10-watt stereo	\$ 4.00
<input type="checkbox"/>	Set of (3) 2200 mfd 75V capacitors for 25 or 50 watt amplifiers	\$ 5.00
<input type="checkbox"/>	4 Amp Bridge Rectifier, suitable for all amplifiers	\$ 2.00
<input type="checkbox"/>	Complete kit for 100 watt RMS stereo amplifier (200 watt music) including two 50-watt Sanken hybrids, all parts, instructions, and nice 1/16" thick, black anodized and punched chassis	\$88.00
<input type="checkbox"/>	Same for 50 watt RMS stereo amplifier, includes two 25 watt Sankens, etc.	\$58.00
<input type="checkbox"/>	Same for 20 watt RMS stereo, includes two Sankens, etc.	\$30.00

## WAVEFORM GENERATOR, BF-5

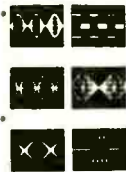

Just one of these BF-5 devices produces sine, square, triangle, ramp and sawtooth waveforms without additional active components. By adding a second BF-5, you can create amplitude, frequency or phase modulated varieties of these waveforms. They are able to replace large discrete waveform generators costing from \$200.00 to \$1300.00. At the same time, they

greatly reduce system weight and power consumption. Full technical data, P.C. layout, assembly, and hook-up instructions included.

BF-5 WAVEFORM GENERATOR . . . . \$ 9.75

## GENERAL ELECTRIC PA-234, 1.4-WATT POWER AMPLIFIER, \$1.25



This amplifier is housed in a plastic dual in-line package with a tab for heat transfer. Has only four active terminals, and requires only one capacitor for stabilization. Compatible with 8, 16, or 22-ohm loads. Applications include P.A. systems, phonos, movie projectors, TV, AM and FM receivers.

PA-234 POWER AMPLIFIER . . . . \$ 1.25

## GENERAL ELECTRIC PA-265 5-WATT VOLTAGE REGULATOR

Housed in plastic dual in-line package with staggered leads and power tab. Usable over wide range of input and output voltages, input voltages to 37 volts and outputs from 3 to 30 volts. Usable in a wide variety of circuits.

PA-265 VOLTAGE REGULATOR . . . . \$ 1.25

## SUPER QUALITY I.C. SOCKETS

Sockets made by T.J. and Cinch. All are low-profile, compact types.

<input type="checkbox"/> 14 Pin Dip Solder Tare Sockets	3 for \$1.25	16 for \$5.00
<input type="checkbox"/> 16 Pin Dip Solder Tare Sockets	2 for \$1.00	13 for \$5.00
<input type="checkbox"/> 14 Pin Dip Gold Wire Wrap Socket	2 for \$1.25	10 for \$5.00
<input type="checkbox"/> 16 Pin Dip Gold Wire Wrap Socket	2 for \$1.50	8 for \$5.00
<input type="checkbox"/> 10 Pin to 5 Gold Sockets (Cinch)	2 for \$1.00	13 for \$5.00
<input type="checkbox"/> 14 Pin Right Angle Socket.	Used to mount L.E.D. displays directly to P.C. board at correct viewing angle	\$1.00

## CALCULATOR CHIP SPECIAL!!!

One of the largest manufacturers of MOS Integrated Circuits has discontinued his three-chip set in favor of a single chip. This is the hobbyist's gain, since he can now obtain this fully tested, highly flexible set at a fraction of what even the largest calculator manufacturers pay. Consists of three 24-pin I.C.'s, has debounced input, eight-digit capacity, decoded seven-segment output. Full data included.

8-Digit Floating-Point Calculator Set . . . . \$9.75

## LOGIC AND OPERATIONAL AMP. SUPPLIES

<input type="checkbox"/> Figure A, plotted logic supply, 5 Volts at 1 Ampere, short circuit proof, ultra high regulation, ultra low ripple	\$16.00
<input type="checkbox"/> Figure A, potted Op Amp supply, +15 Volts, and .15 Volts at 0.5 Amperes. Mfg. by Analog Devices, similar to their model 902. Short circuit proof, ultra high performance	\$29.00
<input type="checkbox"/> Figure B, 5 Volt 1 Amp supply, regulated by Fairchild 9305, short circuit protected	\$ 9.75
<input type="checkbox"/> Same as above, in kit form	\$ 7.75
<input type="checkbox"/> Mating connector for above	\$ 1.00
<input type="checkbox"/> 5 Volt 5 Amp regulated supply, by Blulynne, (not shown)	\$29.00
<input type="checkbox"/> Op amp and logic supply. Supplies ±15 volts at 100 milliampers and 5 volts at 1 ampere. Similar to Figure "B" but larger. Ultra-low ripple. Built by Elcom	\$32.50

## 64 CHARACTER ASCII CODE ALPHANUMERIC L.E.D. DISPLAY

This display consists of 35 L.E.D.'s (light emitting diodes) arranged in a 5 x 7 matrix. Numbers and letters of the alphabet can be formed by lighting the appropriate segments, i.e. from our 2513 character generator Rom. One 2513 can be used to drive up to 64 displays by time sharing. In 14 Pin Dip Package.

<input type="checkbox"/> 64 Character 5 x 7 LED Display	\$ 9.75
<input type="checkbox"/> 2513 Character Generator Rom	\$12.00

## SINGLE CHIP 7-SEGMENT DISPLAY COUNTER, AND DECODER.



That's right! A single chip TTL decade counter with latches, BCD outputs, a 7-segment decoder driver, AND a 7-segment LED display (with decimal) on top. Only 0.15" thick (not counting pins), the chip mounts in a standard 16-pin DIP socket. Digits are 0.270" high and can be latched in during the next count or blanked.

0.27 DLD . . . . . \$15.00

## 70 WATT RMS AUDIO AMPLIFIER BASIC PACKAGE, STEREO \$5.50



Take advantage of Signetic's NE540 power driver, (class AB amp). Designed for 35 watts RMS per channel. Distortion .5% frequency response, ± 5db 20Hz to 100 Hz. NE540 requires two power transistors, a 2N5296 (NPN) and a 2N6109 (PNP), supplied per NE540. Kit package

includes (2) NE540, (2) 2N5296, (2) 2N6109, information on P.C. board layout, parts and circuitry, and a list of miscellaneous small parts required to build the 70 watt amplifier for stereo.

<input type="checkbox"/> NE540	\$2.25/ea.
<input type="checkbox"/> 2N5296 35 watt NPN	.75/ea.
<input type="checkbox"/> 2N6109 40 watt PNP	.75/ea.
<input type="checkbox"/> 70 watt Stereo Kit	\$5.50/ea.
<input type="checkbox"/> 35 watt Mono Kit	\$2.95/ea.

## FAIRCHILD VOLTAGE REGULATORS



This is the UA 7800 Series. Three terminal regulator, with thermal overload protection and internal current limiting, making it essentially blow-out proof. Because simple circuitry is used with this device, designing regulated power supplies is duck soup. Output is rated at 0 to 1 ampere; maximum input voltage is 35 volts. Choice of voltages: 5, 6, 8, 12, 15, 18, or 24 Volts. Order as 7805, 7806, 7808, etc.

Voltage Regulator (Specify Voltage) . . . . \$2.00

## PRINTED CIRCUIT MATERIAL

Epoxy glass G10 material. Specify single or double copper clad. Thickness 1/16 inch.

<input type="checkbox"/> 4 x 12 Sheets	\$1.00, 5 for \$ 3.50
<input type="checkbox"/> 12 x 12 Sheets	\$2.50, 5 for \$10.00
<input type="checkbox"/> Assorted cut pieces at least 4" x 4" 2 square feet	\$2.50

## TTL INTEGRATED CIRCUITS

Unfortunately we have had to raise our TTL prices due to a shortage of material. The following are our new prices. Deduct 15% for 10 or more assorted, 20% for 50 or more.

<input type="checkbox"/> SN7400	\$ .25	<input type="checkbox"/> SN7447	1.50	<input type="checkbox"/> SN74121	.49
<input type="checkbox"/> SN7401	.25	<input type="checkbox"/> SN7448	1.25	<input type="checkbox"/> SN74122	.65
<input type="checkbox"/> SN7402	.25	<input type="checkbox"/> SN7450	.25	<input type="checkbox"/> SN74123	.99
<input type="checkbox"/> SN7403	.25	<input type="checkbox"/> SN7451	.25	<input type="checkbox"/> SN74141	1.45
<input type="checkbox"/> SN7404	.28	<input type="checkbox"/> SN7452	.25	<input type="checkbox"/> SN74145	1.25
<input type="checkbox"/> SN7405	.27	<input type="checkbox"/> SN7454	.25	<input type="checkbox"/> SN74150	1.25
<input type="checkbox"/> SN7406	.45	<input type="checkbox"/> SN7455	.25	<input type="checkbox"/> SN74151	1.13
<input type="checkbox"/> SN7407	.45	<input type="checkbox"/> SN7460	.21	<input type="checkbox"/> SN74153	1.25
<input type="checkbox"/> SN7408	.29	<input type="checkbox"/> SN7470	.39	<input type="checkbox"/> SN74154	1.95
<input type="checkbox"/> SN7409	.29	<input type="checkbox"/> SN7472	.32	<input type="checkbox"/> SN74155	1.39
<input type="checkbox"/> SN7410	.25	<input type="checkbox"/> SN7473	.44	<input type="checkbox"/> SN74156	1.39
<input type="checkbox"/> SN7411	.25	<input type="checkbox"/> SN7474	.39	<input type="checkbox"/> SN74157	1.25
<input type="checkbox"/> SN7413	.75	<input type="checkbox"/> SN7475	1.00	<input type="checkbox"/> SN74158	1.48
<input type="checkbox"/> SN7416	.48	<input type="checkbox"/> SN7476	.44	<input type="checkbox"/> SN74160	1.79
<input type="checkbox"/> SN7417	.48	<input type="checkbox"/> SN7480	.65	<input type="checkbox"/> SN74161	1.79
<input type="checkbox"/> SN7420	.25	<input type="checkbox"/> SN7481	1.10	<input type="checkbox"/> SN74162	1.79
<input type="checkbox"/> SN7421	.25	<input type="checkbox"/> SN7482	.88	<input type="checkbox"/> SN74163	1.79
<input type="checkbox"/> SN7426	.32	<input type="checkbox"/> SN7483	1.25	<input type="checkbox"/> SN74165	3.50
<input type="checkbox"/> SN7430	.25	<input type="checkbox"/> SN7486	.49	<input type="checkbox"/> SN74180	1.10
<input type="checkbox"/> SN7432	.25	<input type="checkbox"/> SN7489	3.50	<input type="checkbox"/> SN74181	4.50
<input type="checkbox"/> SN7437	.50	<input type="checkbox"/> SN7490	1.00	<input type="checkbox"/> SN74182	1.10
<input type="checkbox"/> SN7438	.51	<input type="checkbox"/> SN7491	1.10	<input type="checkbox"/> SN74184	2.50
<input type="checkbox"/> SN7440	.25	<input type="checkbox"/> SN7492	.71	<input type="checkbox"/> SN74185	2.50
<input type="checkbox"/> SN7441	1.30	<input type="checkbox"/> SN7493	.71	<input type="checkbox"/> SN74192	1.75
<input type="checkbox"/> SN7442	1.12	<input type="checkbox"/> SN7494	1.10	<input type="checkbox"/> SN74193	1.75
<input type="checkbox"/> SN7443	1.21	<input type="checkbox"/> SN7495	.95	<input type="checkbox"/> SN74195	1.19
<input type="checkbox"/> SN7444	1.21	<input type="checkbox"/> SN7496	1.10	<input type="checkbox"/> SN74198	2.65
<input type="checkbox"/> SN7445	1.50	<input type="checkbox"/> SN74100	1.41	<input type="checkbox"/> SN74199	2.65
<input type="checkbox"/> SN7446	1.50	<input type="checkbox"/> SN74107	.49		

## CATALOG. Check reader's card or write.

ALL ITEMS (WHERE WEIGHT IS NOT SPECIFIED) POSTAGE PAID IN THE U. S. A.

CHARGES WELCOME!

Phone in charges to 617 531 5774 or 617 532 2323. BankAmericard - Mastercharge. \$10.00 minimum. No C.O.D.'s please.



\$10.00 MINIMUM CHARGE



## B. & F. ENTERPRISES

Phone (617) 532 2323  
P.O. Box 44, Hathorne, Massachusetts 01937

# TRUE TRIGGERED SWEEP OSCILLOSCOPE/VECTORSCOPE

## MODEL TO-50

- DC to 10 mhz frequency response
- .02 volt sensitivity
- Calibrated vertical attenuator
- Calibrated time base
- Supplied with combination Direct/Lo-Cap probe
- 5 X magnifier
- Automatic triggering mode
- 5" flat face tube edge-lit graticule



One Year Warranty  
Made in U.S.A. **339<sup>50</sup>**



See your distributor or write Dept. RE-2  
**LECTROTECH, INC.**  
5810 N. Western Ave., Chicago, Illinois 60659

Circle 85 on reader service card

## TRANSFORMERS FOR ALL SEMICONDUCTOR PROJECTS

22 volts, 0.5 amp. 2"x1½"x1½" 1.75 ea. 4/6.00 NO.J9451  
48 volts ct, 0.5 amp. & 5.5 volts, 0.5 amp. 2¼"x2¼"x2"  
2.50 ea. 4/9.00 NO.J9450  
12 volt ct, 4.0 amp. & NIXIE winding, 170 volts, 150 ma.  
2½"x3"x2¼" 3.50 ea. 4/13.00 NO.J9449  
16 volts, 3 amps. & 30 volts, 1.0 amp. & NIXIE winding,  
150 volts, 100 ma. 3 3/8"x2 7/8"x2¼" 3.00 ea. NO.J9254  
34 volts ct, 5.0 amp. & 5 volts, 1.5 amp. 3¼"x3¼"x2¼"  
5 lbs. 5 lbs. 4.75 ea. 2/9.00 NO.J9448

## NEW FAIRCHILD TTL, DTL, MSI IC BOARDS

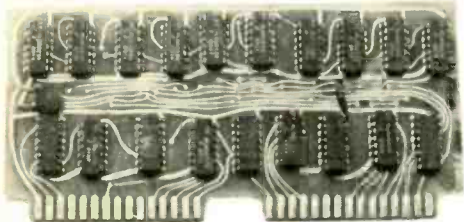

New boards, with 15 to 20 marked Fairchild TTL,DTL,MSI  
DIP ICs. 2.75 ea. 2/5.00 3/7.00 NO.J5054

## COMPUTER GRADE CAPACITORS (NEW)

40,000 MFD.	10 volts	1.25 ea.	6/7.00	NO.F2026
70,000 MFD.	10 volts	1.75 ea.	6/9.00	NO.F2118
32,000 MFD.	40 volts	2.00 ea.	6/11.00	NO.J2210
3,750 MFD.	75 volts	1.75 ea.	6/9.00	NO.J2116

Include sufficient postage, excess will be refunded. Send for new  
48 page catalog loaded with other items. Minimum order \$3.00



# DELTA ELECTRONICS CO.

BOX 1, LYNN, MASSACHUSETTS 01903  
Phone (617) 388-4705

Circle 86 on reader service card

102 RADIO-ELECTRONICS • FEBRUARY 1973

# technotes

## GENERAL ELECTRIC C-2/L-2 CHASSIS

Complaints of no raster and no sound may be traced to an open circuit in resistors 2R406, 2R404, or 2R407; shorted Zener diode 2Y405 (see diagram) or an open heater in the 19CG3 damper tube.

IF 2R406 is the troublemaker, replace it with another resistor of equal value. If the trouble is in 2R404, replace a 2-

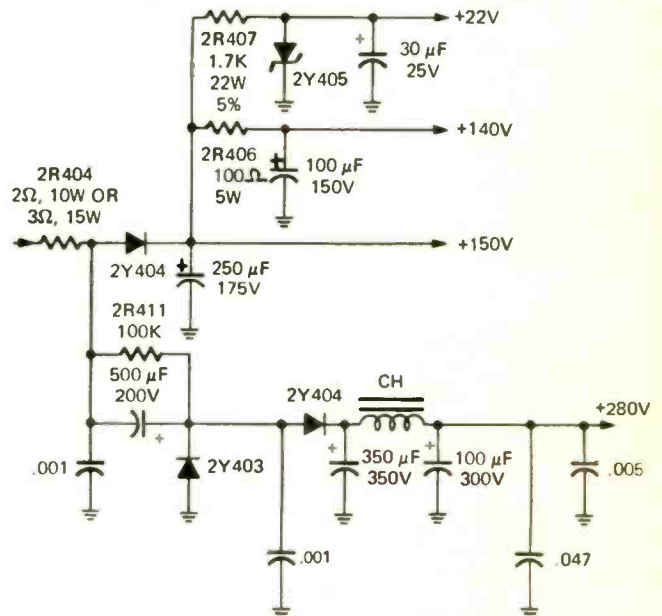

ohm, 10-watt original component with a 2-ohm, 15-watt unit (part EP14X9). Replace the 3-ohm, 15-watt resistor used in late production with a 3-ohm, 22-watt unit (part EP14X24).

If the Zener diode is shorted or has a low resistance, there is no 22-volt B+; the 22HU5 horizontal output tube runs hot and the breaker trips.—*G-E Troubleshooting Guide*

## SYLVANIA D-12 CHASSIS

Overbright picture and blooming may be a tough-dog complaint on this chassis. This trouble has been traced to R428, the horizontal oscillator plate resistor. This resistor overheats and its value drops from 18,000 to around 9,000 ohms. Replacing it with a 1-watt resistor eliminates the complaint.—*GTE Sylvania Service Notebook*

## MAGNAVOX T979 COLOR CHASSIS

Intermittently a bright horizontal bar moves vertically through the bottom one-third of the screen. Vertical jitter may also be present. Some cases can be corrected by tapping or moving certain parts on the "D" panel.

Investigation shows that this condition may be caused by a contaminate, such as solder flux, on the "D" panel plug-in socket pins—on pins 5, 6 and 7 in particular. If you encounter this condition, both the male pins on the chassis and the female connectors on the "D" panel should be cleaned with an approved cleaner, which will not react with the PC board or adjacent components. The inside of the female connectors should be cleaned using an applicator such as a toothpick and then thoroughly dried.—*Magnavox Service News Letter*

R-E

# ARIES



## NEW FROM ARIES! ULTRA LOW COST DIGITAL CLOCK (STANDARD TIME CHRONOMETER)

Aries/BF has sold over 12,000 digital clocks, to the best of our knowledge more than the combined output of all other manufacturers. Because of our huge purchasing power, and the engineering background gained, we can offer the features listed below. Compare with any other manufacturer and see if they can offer all these features:

- Decorator solid walnut case. A Striking addition to even the most luxurious living room. Our sketches just don't do it justice.
- Superb accuracy, seconds per month
- Choice of 50 or 60 Hz operation, 12 or 24 hour display in hours, minutes, seconds.
- BCD outputs, for auxiliary readouts etc.
- Excellent beginners kit, elaborate step by step instructions debugged by trial construction by experimenters who have never built a kit before. Only a soldering iron, wire snip and screwdriver needed. Guaranteed success (maximum repair charge \$10.00)

Low-cost Digital Clock Kit..... \$47.50

### OPTIONS

- 00 - Standard readouts, GE fluorescent standard unless otherwise specified. Cool blue green color, best for decor of living rooms, bedrooms etc., this is the unit that draws Oh's and Ah's.
- 01 - Burroughs B5750 nixie tube readout instead of GE hot orange color. Looks at home in a lab. No extra charge.
- 02 - Man 1 L.E.D. readouts. Intense red, monochromatic light output, laboratory environment type display. Add \$22.50 additional for this display.
- 03 - Quartz crystal time standard. In most environments standard line operated units will give accuracy of a second a month. If you live in an area where line frequency is poor, this will give you an independent time base of .0005% accuracy when properly trimmed. Add \$22.50 for this crystal time base.
- Special - National MM5311 clock chip and readouts only, with instructions for do it yourself clock projects. Specify GE fluorescent or Burroughs B5750 nixie tubes as readouts ..... \$24.50

## TEXAS INSTRUMENTS "ELECTRONIC SLIDE RULE" CALCULATOR



This brand new calculator from T.I. promises to revolutionize engineering calculations! Use scientific notation, i.e., 4235.7867 is expressed as 4.2357867 x 10<sup>3</sup>. Does squares, square roots, reciprocals, adds, subtracts, multiplies, divides. If you have been looking at electronic slide rules

you know what a phenomenal deal this is. By the way this is direct entry as opposed to HP's indirect entry.

T.I. "Electronic Slide Rule" ..... \$149.00

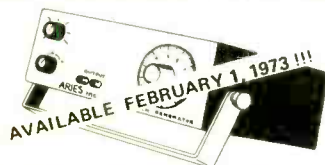

## FUNCTION GENERATOR KIT IMPOSSIBLE?

A \$700.00 function generator for \$99.00? But true! The new, low-cost EXAR-205 monolithic waveform generator makes this price possible. Our kit uses two generator circuits - one is a carrier generator, and produces sine, triangle, square, sawtooth, ramp and pulse waveforms. The second is a modulation generator, for amplitude or frequency modulation of the output waveforms. Output frequency range is from 20 Hz to 1.5 megahertz. Modulation is switch-selectable for internal AM, internal FM, or external modulation.

Model AR-620K Function Generator . . . \$99.00

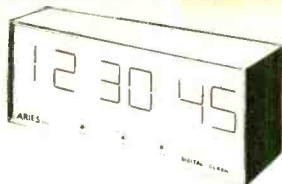

## GIANT 2 1/2" NUMERAL "NIXIE" CLOCK KIT

New! For factories, offices, and commercial establishments, and those people who like large displays, characters appear as a bright continuous line which can be read from distances as great as 150 feet. All drive circuits are solid state, and unit employs new custom LSI clock chip. Indicates hour, minutes, and seconds. May be wired for 24 hour or 12 hour operation with a simple jumper change. Kit offered complete with or without case for custom installations. Parts include P.C. board, sockets, solid state components, hardware, resistors, caps, viewing filter, etc.

Sh.Wt. 15 lbs.

- GNCC/With Case ..... \$98.50
- GNCC/Without Case ..... \$84.50

## VIEW HOLOGRAMS! PERFORM OTHER EXCITING EXPERIMENTS LASER KIT!



Now available only from Aries! Brand new Hughes "Hip Pocket" type tube, and Aries power supply kit, plus complete experimental accessories. These tubes are completely guaranteed by Aries and Hughes, but are available at this bargain price because their power output is slightly below Hughes standard. Because of this fortunate purchase, you can purchase the complete experimental kit for less than the price of the tube alone. The Hughes specification for this tube is 1.4 milliwatts output power when new, so that minimum power specification of 1 milliwatt can be met throughout life of tube. Our specification is initial power between 0.9 and 1.4 milliwatts, guaranteed not to go below 0.5 milliwatt during the guarantee period (6 months continuous operation!) Our kit includes experimental accessories such as lenses, pinholes, mirrors and a hologram to perform hundreds of fascinating experiments. Holograms viewing is easily demonstrated with this kit, hologram making is possible, but is recommended only for advanced experimenters.

Laser Experimental Kit ..... \$119.00



## 50 MHz DIGITAL COUNTER LABORATORY SPECIFICATIONS AT A BUDGET PRICE!

We feel the most important thing about building a kit is saving money. There are a lot of other advantages of course . . . maintainability, use of standard parts, complete documentation, and the experience and fun of building it, but the overriding consideration is economy. This kit costs less than half that of the lowest priced competitive unit on the market.

The Aries 50 MHz counter is designed for years of maintenance free service. MSI integrated circuitry, cold cathode display tubes and conservatively rated transformers mean low temperature rise. All displays and I.C.'s are in sockets for easy maintainability. The master oscillator is a 1.0 MHz crystal in a custom designed cosmo oscillator circuit, having a stability of ± 3 PPM. Accuracy is 0.005% worst case, 0.0002% or better when adjusted to WWV with a communications receiver. A front panel selects a timing interval of 1.0 seconds, 0.1 seconds or 10 milliseconds. A variable monostable multivibrator holds the count on the front panel for a period of a fraction of a second to infinity. For use in the period mode, the 1.0 MHz oscillator is connected to the main counting chain and gated by the input signal.

Assembly time for the kit is approx. 10 hours. The semiconductor complement is (1) 7400, (1) 7408, (1) 7442, (10) 7490, (2) 74122, (6) 74141, (1) 74193, (1) 74196, (1) 74S11, (1) CD 4007AE, (1) LM309, (6) Diodes, and (1) Transistor. If you always wanted a laboratory quality counter, but could never justify the price, here is your chance.

50 MHz Counter Kit, Complete with Crystal Time Base and Case - Postpaid in USA . . . \$125.50



## POCKET CALCULATOR

We expected a favorable reaction to our calculator, however, we were overwhelmed when we received orders for hundreds at a time. The reaction of our customers was that they felt this was the most advanced pocket calculator on the market, and priced so low, they could assemble and market it at a profit. The features that make this so exciting are:

- So compact it fits in a shirt pocket (3-13/16 x 4-5/8 x 1-1/4).
- Performs every function you would expect in a desk calculator, and then some, multiplies, divides, adds, subtracts and gives true credit balance. Includes constant and chain operation, full floating decimal, suppressed trailing zeroes, and automatic single entry squaring.
- Powered by self contained AA batteries with up to six hours operation (Nicaid batteries with charger option, up to five hours per charge).
- Calculations performed by a single 40 pin LSI (large scale integration) chip. Displays are 8 digit LED's (light emitting diodes) and overflow and minus signs are also LED's.

As a student, engineer, salesman, accountant or anyone who would like fast accurate answers, this calculator fills the bill, and at a price that unquestionably makes this the lowest price high quality calculator available.

- Pocket Calculator Kit ..... \$75.00
  - Pocket Calculator Completed ..... \$99.00
  - NiCad Batteries & Charger ..... \$17.50
  - Batteries & Charger Completed ..... \$25.00
- Check Enclosed  Master Charge  BankAmericard

Charge No.

ARIES, Inc.  
119 Foster Street, Peabody, Mass. 01960  
(617) 532-0450

## AIRCRAFT/AUTO/BOAT QUARTZ CRYSTAL CHRONOMETER



Revolutionary! was the reaction of our customers when they saw our latest kit. Measuring only 2 1/2" x 2 1/2" x 2-3/8", and accurate to 10 seconds a month, this chronometer promises to entirely replace mechanical clocks in cars, boats and airplanes.

Fits into a standard 2 1/4" instrument panel cutout. The displays are bright L.E.D. displays that should last a lifetime. Setting controls are recessed and operate from a pointed object such as a pencil point or paper clip, in order to keep non-authorized hands off. The clock should only have to be reset at very great intervals, or in the event of power loss (i.e. replacing battery in car). The clock is wired so that the timing circuits are always running, but the displays are only lit when the ignition is on, resulting in negligible power drain. The low price is only possible because of a new one chip MOS clock circuit, developed for quartz crystal wristwatches.

Operates from 10-14 Volts D.C. An accessory unit which mounts on the back adapts the unit 59 20-28 volts for twin engine aircraft and larger boats using 24 Volts ignition. Know how disgusted you are with the usual car clock? Order this fine unit now for rallying, sports events, navigation, or just to have a fine chronometer that will give you a lifetime of superbly accurate time.

- Quartz Chronometer, Kit Form..... \$69.50
- Quartz Chronometer, Wired ..... \$99.50
- 24 Volt Adapter ..... \$10.00

Circle 87 on reader service card

# ELECTRONIC TECHNICIANS!

Raise your professional standing and prepare for promotion! Win your diploma in

## ENGINEERING MATHEMATICS

from the Indiana Home Study Institute

We are proud to announce two great new courses in Engineering Mathematics for the electronic industry.

These unusual courses are the result of many years of study and thought by the President of Indiana Home Study, who has personally lectured in the classroom to thousands of men, from all walks of life, on mathematics, and electrical and electronic engineering.

You will have to see the lessons to appreciate them!

NOW you can master engineering mathematics and actually enjoy doing it!

WE ARE THIS SURE: you sign no contracts—you order your lessons on a money-back guarantee.

In plain language, if you aren't satisfied you don't pay, and there are no strings attached.

Write today for more information and your outline of courses.

You have nothing to lose, and everything to gain!

### The INDIANA HOME STUDY INSTITUTE

Dept. RE-2, P.O. Box 1189, Panama City, Fla. 32401

Circle 88 on reader service card

# HARD-TO-FIND TOOLS

FOR ELECTRONICS AND FINE MECHANICS



Free Catalog →

Includes 72 pages of hard-to-find tools used by electronic technicians, instrument mechanics, engineers, scientists. Over 1700 items listed. Write today.



JENSEN TOOLS and ALLOYS  
4117 N. 44TH STREET, PHOENIX, ARIZONA 85018

Circle 89 on reader service card

## CIRCUITS (continued from page 99)

purchased or selected on a bridge from 5% or 10% stock. The other standard capacitors can be selected to near-equal precision from service-grade capacitors.

Simply set the range switch to the 1000 pF range, connect the 1000-pF precision capacitor to the TEST terminals and adjust the pot so the meter reads one-tenth fullscale or 10 on a 100  $\mu$ A scale. Now, without touching the pot setting, select and substitute a .01- $\mu$ F capacitor that will cause the meter to read exactly fullscale. Thus, selected capacitors can be used to select other range capacitors with ten times and one-tenth their value.

### STARTING NEGATIVE-RESISTANCE DEVICES

A bit of inductance (L) in series and a little capacitance (C) in shunt, will start negative-resistance devices whose firing voltage is a little higher than the supply voltage. For example, neon lamps that work on 115 volts ac but not on 115 volts dc.

In the circuit shown, the theoretical peak voltage is 2E when we disregard the resistance in inductor L. Thus type NE-2 neon lamps connected this way will light on 90 volts or less and are handy as low-drain pilot lamps.

V → 2E WHEN S1 CLOSED

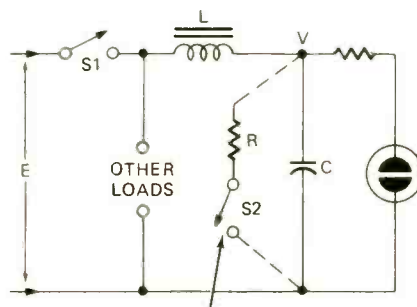

V >> E WHEN S2 IS OPENED AFTER CLOSING

Of course, if you add a switch with a limiting resistor to temporarily short C—as is done when starting fluorescent lights—you get a peak voltage many times E when you open this switch. In this case C may be only stray capacitance.—A. H. Taylor R-E



"There's no use talking into the intercom... that's what we came to fix."

# DISCOUNT PRICES TEST EQUIPMENT



Catalog & Prices on Request

**FORDHAM** Radio Supply Company, Inc.  
558 Morris Ave.  
Bronx, N.Y.  
Tel: (212) 585-0330 **RCA**

DISTRIBUTORS OF ELECTRONIC SUPPLIES

Circle 90 on reader service card

## INTERNATIONAL ELECTRONICS UNLIMITED

ENTERS THE MAIL ORDER BUSINESS WITH "SPRING SPECIALS"

7400	7401	7402	7403	EACH \$2.20
7404	7405	7408	7410	
7420	7430	7440	7460	

### LOW POWER DEVICES

74L00	74L02	74L04	EACH \$4.00
74L20	74L30	74L51	
74L71	74L72	74L73	

7441	7442	EA. \$ .90	7489	EA. \$3.25
7447	7448	EA. .90	7490	EA. .69
7473	EA. .40	7491	EA. 1.05	
7474	EA. .30	7495	EA. .85	
7475	EA. .69	74154	EA. 1.75	
7483	EA. 1.20	74165	EA. 1.75	
7486	EA. .45	74181	EA. 4.50	

### LINEAR SPECIALS

LM 309K (TO3) 5 volt reg.	EA. \$1.95
LM 309H (TO5) 5 volt reg.	EA. .95
709 Op. AM.	35¢ or 10 For \$3.00
741 Op. AM.	45¢ 10 For \$4.00

### CALCULATOR CHIP

5001 LSI Calculator Chip  
One Chip Calculator Each \$9.95  
with complete info.

### LED DISPLAY

7 Segment (MANI) Display Each \$3.95

8223 Field Programmable Rom  
256 Bit with 32 8-bit words  
EXTRA SPECIAL EACH \$7.95

Min. order \$4.00 Prepaid in U.S.  
Orders Filled Within 3 Days After Receipt.

## INTERNATIONAL ELECTRONICS UNLIMITED

P.O. BOX 2238  
WALNUT CREEK, CALIF. 94595

Circle 91 on reader service card

# market center

## WANTED

**BUYING** baseball cards issued with gum, tobacco, etc. before 1960. Send cards for appraisal and offer at my expense. **RUSSELL WALTERS**, 622 E. Sunset Drive, No. Muskegon, Mich. 49445

**QUICK** cash . . . for electronic equipment components, unused tubes. Send list now! **BARRY**, 512 Broadway, New York, N.Y. 10012, 212 Walker 5-7000

## TUBES

**RADIO** and TV tubes 36¢ each. One year guaranteed. Plus many unusual electronic bargains. Free catalog. **CORNELL** 4217-E University, San Diego, Calif. 92105

**SAVE** money on parts and transmitting-receiving tubes, foreign-domestic. Send 25¢ for Giant Catalog. Refunded first order. **UNITED RADIO COMPANY**, 56-R Ferry Street, Newark, N.J. 07105

**Independent News Company, Inc. is pleased to announce a Retail Display Plan which includes Radio-Electronics as part of a group of magazines available for the earning of a Display Allowance.**

To obtain details and a copy of the formal contract please write to **Marketing Department, Independent News Co., Inc., 909 Third Avenue, New York 10022 (Attention Mr. Randy Ardissone)**. Under the Retail Display Plan in consideration of your acceptance and fulfillment of the terms of formal contract to be sent to you upon request you will receive a Display Allowance of 10% of the cover price per copy of each magazine in the group sold by you. This plan will become effective with all issues of the magazine group delivered to you subsequent to the date your written acceptance is received and accepted by our Company.

**CLASSIFIED COMMERCIAL RATE** (for firms or individuals offering commercial products or services). \$1.00 per word . . . minimum 10 words.

**NONCOMMERCIAL RATE** (for individuals who want to buy or sell personal items) 70¢ per word . . . no minimum.

**FIRST WORD** and **NAME** set in bold caps at no extra charge. Additional bold face at 10¢ per word. Payment must accompany all ads except those placed by accredited advertising agencies. 10% discount on 12 consecutive insertions, if paid in advance. Misleading or objectionable ads not accepted. Copy for April issue must reach us before Feb. 1.

## CLASSIFIED ADVERTISING ORDER FORM

1	2	3	4	5
6	7	8	9	10
11	12	13	14	15
16	17	18	19	20
21	22	23	24	25
26	27	28	29	30
31	32	33	34	35

No. of Words { @ .70 Non-Commercial Rates } = \$  
 { @ \$1.00 Commercial Rate } = \$  
 No. of Words in bold caps @ .10 = \$

Total Enclosed \$

Insert \_\_\_\_\_ time(s)

Starting with \_\_\_\_\_ issue

Payment must accompany order unless placed through accredited advertising agency 28

NAME \_\_\_\_\_

ADDRESS \_\_\_\_\_

CITY \_\_\_\_\_ STATE \_\_\_\_\_ ZIP \_\_\_\_\_

SIGNATURE \_\_\_\_\_

MAIL TO: RADIO-ELECTRONICS, CLASSIFIED AD DEPT., 200 PARK AVE. SOUTH, NEW YORK, N.Y. 10003



# FREE

**SWT** CATALOG

Now Get

## MUSIC ONLY FM Programs

Convert ANY FM TUNER to receive uninterrupted commercial free music being broadcast by many stations.



New three transistor plus "Phase locked loop" IC circuit gives you perfect reception. No tuned circuits, or critical adjustments. The 1 1/2" x 4" circuit board is powered from the tuner supply. +9 to 12 Volts DC @ 10 Ma. required.

Kit Only  
**\$1450**

With Squelch  
**\$1950**

Wired & Tested  
**\$2500**

Free list of FM stations with SCA authorizations included (List alone \$ .25)

With Squelch  
**\$2995**

BankAmericard  
or  
Master Charge  
Welcomed

Plus Postage  
and insurance.

**THOUSANDS SOLD**



**SOUTHWEST TECHNICAL PRODUCTS CORPORATION**

BOX 32040 R • SAN ANTONIO, TEXAS 78284

Circle 101 on reader service card

**GIANT B-7971 NIXIES (2)** with 2 sockets and driver board containing hi voltage transistors. Complete plug-in board as removed from operational equipment. Schematics included. Unbelievable but true . . . just \$2.50 for the complete package.  
#72S-10 **\$2.50**

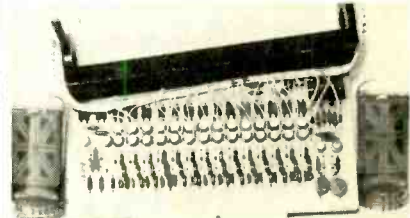

**ALPHA-NUMERIC** keyboard removed from unused IBM Selectric machines. Bargain price at only **\$8.00**

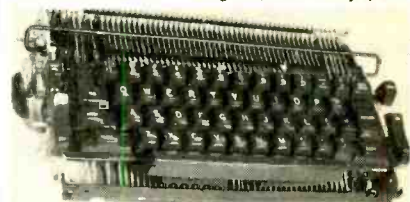

### 15¢ IC BONANZA

Brand new DTL dual inline (DIP) package, factory marked ceramic type. The price is too good to be true. Fully guaranteed and with specs.

930 Dual 4 input NAND gate similar to	7420
931 Clocked flip flop	74110
932 Dual 4 input Expand Buff	7440
933 Dual 4 input expander	7460
936 Hex Inverter	7405
945 JK Flip Flop	74110
946 Quad 2 input gate	7400
962 Triple 3 input gate	7410

15¢ each. Buy \$100 worth and deduct 10%  
24 hour delivery guaranteed.

Please add postage for above.

**JOHN MESHNA JR.**

PO Box 62, E. LYNN, MASS. 01904

Circle 102 on reader service card

**TUBES-IEC 70% disc. 5 FREE with ea. 50. SENCORE, EICO, MALLORY, HEP, SHURE.** Also cartridges, needles lowest prices. Full guarantee. **M & K ELEC. DIST.,** 135-33 Northern Blvd., NYC 11354

**RECEIVING & industrial tubes, transistors.** All brands—Biggest discounts. Technicians, hobbyists, experimenters—Request free giant catalog and save! **ZALYTRON,** 469 Jericho Turnpike, Mineola, N.Y. 11501

**FOR SALE**

**1973 HOBBY ELECTRONICS DIRECTORY.** Hundreds of companies, products and services. Parts, test equipment, surplus, plans, kits, and more. \$1.50, **NEWCAL ENTERPRISES,** Box 323-C, El Segundo, Calif. 90245

**50W RMS / 8Ω AUDIO AMPLIFIER MODULES.** IM and THD 0.5%. Frequency Response 20HZ - 20KHZ ±1.0 db. SN ratio 85 db. 1 x 1½". Model A-501. Guaranteed. \$21.95 ppd. **D. GRAHAM R.F.D. 1,** Box 166, Greenville, N.H. 03048

**SHIFT REGISTER 200 BITS TTL COMPAT. \$2.25 @ 5/\$10.00, FREE 4 PGS. DATA, AND APPLICATION NOTES W/ORDER. DRAGER,** 385E Mosholu Pky No., Bronx N.Y. 10467

**PRINTED Circuits—Free pricing guide determines costs for any quantity. BLAKESLEY ELECTRONICS,** Box 686B, Syracuse, Ind. 46567.

**IC MANUAL LISTING MORE THAN 500 COMMON DIGITAL IC's WITH PIN CONNECTION DIAGRAMS, \$2.75. ELECTRONETICS,** Box 278, Cranbury, N.J. 08512

**ADVERTISING INDEX**

**RADIO-ELECTRONICS does not assume responsibility for any errors which may appear in the index below.**

READER SERVICE CARD NO.	PAGE
87	Amperex..... 2
	Aries, Inc..... 103
	Bell & Howell Schools..... 28-31
84	B.F. Enterprises..... 101
11	B & K, Division of Dynascan Corp..... 23
77	Brooks Radio & TV Corp..... 96-97
78	Castle TV Tuner Service, Inc..... 98
14	Channel Master..... 25
22	Cleveland Institute of Electronics..... 74-77
94	Conway Electronics Enterprises Ltd..... Cover IV
	CREI, Division of the McGraw-Hill Continuing Education Co..... 64-67
10	Crown International..... 22
86	Delta Electronics..... 102
81	Delta Products, Inc..... 99
13	Dictaphone Corp..... 24
92	Edmund Scientific Co..... 110
65	EEP Corp..... 87
73	Electronic Distributors, Inc..... 91
76	EICO, Electronics Instrument Co..... 97
8	EMC, Electronic Measurements Corp..... 98
	Electro-Voice, Inc..... 16
67	Enterprise Development Corp..... 88
17	ES Enterprises..... 32
83	Esse Radio Co..... 100
63	John Fluke Mfg. Co., Inc..... 85
90	Fordham Radio Supply Co..... 104
7	Grantham School of Engineering..... 15
	GTE Sylvania..... 81
66	HM Electronics, Inc..... 87
100	Heath Co..... 92-95
2	ICS School of Electronics..... 1
88	Indiana Home Study Institute..... 104
62	International Components Corp..... 84
23	International Crystal Mfg. Co..... 78
91	International Electronics Unlimited..... 104
89	Jensen Tools & Alloys..... 104
79	Judson Research & Mfg. Co..... 99
69	Lafayette Electronics..... 89
25	Leader Instruments..... 80
85	Lectrotech, Inc..... 102
3	Mallory Distributor Products Co..... 5
16	McGraw-Hill Book Co..... 27
	Micro-Instrumentation Telemetry Systems, Inc..... 34
80	National Camera Co..... 99
	National Radio Institute..... 8-11
	National Technical Schools..... 18-21
6	Olson Electronics..... 14
71	Oneida Electronic Mfg. Co., Inc..... 90
20	Perma-Power..... 72
18	Radio Shack..... 33
	RCA Electronic Components Semiconductors..... 17
61	Solid State..... 83
	RCA Institutes..... 46-49
1	RCA Parts & Accessories..... Cover II
75	Rye Industries, Inc..... 96
68	S & A Electronics..... 88
21	Sams & Co., Howard W..... 73
24	Sansui..... 79
15	Schober Organ..... 26
95	Sennheiser Electronic..... 89
93	Shure Bros..... Cover III
4	Sprague..... 7
12	Telematic..... 24
64	Telex..... 86
70	Tescom, Corp..... 90
72	Tri-Star Corp..... 91
5	Tuner Service Corp..... 13
74	TV Tech Aids..... 91
82	Vero Electronics, Inc..... 100
	<b>MARKET CENTER..... 105-109</b>
	ATV Research Corp..... 107
	Automatic Service Co..... 107
	Barta-DRA..... 107
	Command Productions..... 107
104	Digi-Key..... 107
	Fair Radio Sales..... 109
	Hunnicut Digital Elec..... 109
106	JTM Associates..... 109
	Lakeside Industries..... 107
	Lesco Electronics..... 107
102	Meshna Electronics, John Jr..... 105
105	Polypaks..... 108-109
103	Solid State Sales..... 106
101	Southwest Technical Products..... 105
	Startronics..... 109
	United Sales..... 109
	Yeats Appliance Dolly Sales Co..... 109
	<b>SCHOOL DIRECTORY..... 109</b>
	Valparaiso Technical Institute..... 109

**SCHOTTKY IC's**

74S00—.99	74S64—.99
74S03—.99	74S73—1.95
74S04—.99	74S74—1.75
74S05—.99	74S107—1.95
74S08—.99	74S108—1.95
74S10—.99	74S112—1.95
74S11—.99	74S113—1.95
74S20—.99	74S114—1.95
74S22—.99	74140—.99
74S40—.99	74S153—1.95
74S51—.99	74S157—1.95

**TRANSISTOR SPECIALS**

2N965	PNP	6E	TO-18	.15W	7V	.1A	300MHZ	40Htz	5/\$1.00
2N1605	NPN	6E	TO-5	.15W	24V	.1A	14MHZ	125	5/\$1.00
2N2360	PNP	6E	TO-33	.06W	20V	.05A		980	32 \$ .50
2N5324	PNP	6E	TO-3	60W	250V	10A		20	35 \$1.50
2N1015D	NPN	SI	TO-82	150W	200V	7.5A		.025	10 \$1.45
2N2015	NPN	SI	TO-36	150W	50V	10A		.012	26 \$ .90
2N3584	NPN	SI	TO-66	35W	250V	2A		10	100 \$1.50
2N3055	NPN	SI	TO-3	115W	100V	15A		.01	50 \$1.00
2N3772	NPN	SI	TO-3	150W	60V	30A		.2	30 \$1.25
2N5296	NPN	SI	TO-220	36W	40V	4A		.8	60 \$ .50
2N6109	PNP	SI	TO-220	36W	40V	4A		.8	60 \$ .55
2N4898	PNP	SI	TO-66	25W	40V	4A		4	46 \$ .60
MJ2251	NPN	SI	TO-66	10W	225V	.5A		10	40 \$ .70

**PRINTED CIRCUIT BOARD**  
3¼" x 6" single sided paper epoxy board 1/16" thick unetched  
**3 boards/\$1.00**

7 segments 5V 8ma, 16 pin DIP display, 250,000 hr. lifetime  
**\$3.25**

**DECADE COUNTER KIT**  
CONSISTING OF:  
1—NIXIE TUBE and SOCKET  
1—7490 1—7475 1—7441  
Special priced at \$5.50

**NIXIE TUBES**  
Similar to Raytheon 8754 tubes, with socket & data sheet  
**\$2.25 3/\$6.00**

2N3819 FET \$ .45  
T1S43 UJT \$ .50

**LSI CALCULATOR CHIP**  
A 40 pin DIP unit that adds, subtracts, multiplies and divides. Used in a 12 digit calculator 7 segment MOS levels. Data sheets included. \$12.50

**ER900 TRIGGER DIODES.** These bidirectional trigger diodes are one of the best and cheapest methods to trigger SCR's and triacs .4/\$1.00  
FLV 100 Visible LED \$ .65  
GaAs IR LED \$ .65  
MRD 14B photo darlington \$ .65  
¾" reed switch 6/\$1.00  
1N4886 25-40W Power varactor \$4.95

**TRIACS**

PRV	1A	10A	15A	20A
100	.30	.60	.85	1.05
200	.65	.85	1.25	1.45
300	.75	1.10	1.45	1.65
400	.90	1.35	1.75	1.90
500	1.20	1.50	2.50	2.20

\*Press fit

Dual photo ELECTRIC CELL a COMPLETE substrate circuit, with photo cells, transistors and resistors, used to shut off and on light sensitive circuits \$1.75

**MAN-1 LED**

5 Volt READOUTS  
**\$4.50**

8223 field prog. ROM \$8.00  
1101 256 bit RAM \$4.00

**Full Wave Bridges**

PRV	2A	6A
200	.95	1.25
400	1.15	1.50
600	1.35	1.75

**TANTULUM CAPACITORS**

4.7 MFD at 20V	5/\$1.00
10 MFD at 20V	4/\$1.00
4.7 MFD at 100V	.50
10 MFD at 100V	.75
200 PRV 15A full wave rectifier	\$.95

**TTL IC SERIES**

7400—.25	7476—.60
7401—.25	7480—.65
7402—.25	7481—1.25
7403—.25	7483—1.25
7404—.28	7486—.60
7408—.25	7490—1.00
7410—.25	7492—.79
7416—.48	7493—.79
7420—.25	7495—.90
7430—.25	74107—.60
7440—.25	74121—.70
7441—1.30	74141—1.35
7442—1.50	74154—1.95
7446—1.50	74161—1.79
7447—1.50	74192—1.75
7448—1.25	74194—2.35
7450—.25	8570—1.90
7460—.25	8590—1.90
7472—.40	9309—1.95
7473—.75	9312—1.95
7474—.50	9322—1.95
7475—1.00	

14 Pin DIP sockets 3/\$1.00  
16 Pin DIP sockets .60

**TEN TURN TRIM POTS**

500ohm, 10K, 20K, 25K  
50K \$ .75 3/\$2.00

**Silicon Power Rectifiers**

PRV	1A	3A	12A	50A
100	.06	.09	.24	.90
200	.07	.12	.20	1.25
400	.09	.16	.35	1.50
600	.11	.20	.50	1.80
800	.15	.28	.70	2.30
1000	.20	.35	.90	2.75

**LINEAR CIRCUITS**

PA234 1W audio ampl.	\$1.25
PA264—5 Watt regulator	\$1.25
LM309K 5V 1A regulator	\$2.25
SE 501 Video Amp	\$1.00
531 High slew oper amp	\$2.50
536 FET input oper amp	\$3.95
537 Precision 741	\$2.50
540 70W Power driver	\$2.04
555 2 us to 1 hour timer	\$1.19
560 phase lock loop	\$3.25
561 phase lock loop	\$3.25
565 phase lock loop	\$3.35
566 Function gen	\$3.25
567 Tone decoder	\$3.25
703 RF—IF amplifier	\$1.00
Dual 709	\$.95
709C operational Amp	\$.39
723 Regulator	\$.75
741 operational Amp	\$.39
747 Dual 741	\$1.25
748 Adjust 741	\$.44
TVR 2002 high power	
723	\$1.00
CA3065 FM/TV amp	\$1.35
5558 dual 741 (mini-DIP)	\$.88

**Silicon Control Rectifiers**

PRV	6A	10A	20A	70A
50	.25	.32		
100	.30	.45	1.00	3.50
200	.50	.75	1.25	6.50
300	.60	.90	1.50	
400	.70	1.10	1.75	9.50
500	.80	1.25	2.00	
600	.90	1.40	2.25	11.00

Terms: FOB Cambridge, Mass. Send check or Money Order. Include Postage. Average Wt. per package ½ lb. No. C.O.D.'s. Minimum Order \$3.00

Send for our fall catalog featuring Transistors and Rectifiers; 325 Elm St., Cambridge, Mass.

**SOLID**

**TATE SALES**

Post Office Box 74D

Somerville, Mass. 02143

Tel. (617) 547-4005

Circle 103 on reader service card

PRINTED circuits—low cost, CIRKUT BOARDS  
Box 3193 Station C, Toledo, Ohio 43607

TV tuner repair, VHF or UHF \$9.50 plus major parts and shipping. One year guarantee. NEW CUSTOMERS SAVE \$2.00 WITH THIS AD. We ship C.O.D. UNITED TUNER SERVICE, Box 1383, 210 Gordon Pike, Bloomington, Ind. 47401

FREE catalog of amplifiers, inverters, burglar alarms, power supplies, car accessories, etc. Write: C.P.A. RADIO 2115 Norris Canyon Road, San Ramon, Calif. 94583

B & K, SENCORE TEST EQUIPMENT, DISCOUNT PRICES. FREE CATALOG AND PRICE SHEET. FORDHAM RADIO, 558 Morris Avenue, BRONX, N.Y. 10451

CALCULATOR chip, TI MOS \$65.00, Digital Clock chip \$25.00, data only \$1.50. D & C CO., Box 255, Collingswood, N.J. 08108

RECORD telephone conversations—automatically. Leave recorder unattended. ROBERT'S, Box 49RE, Parkridge, Ill. 60068

PHOTOFLASH: FT 106C, 800µF, trigger coil—\$12.50. Catalog. TRANSPARK Dept. R., Carlisle, Mass. 01741

FREE catalog lists resistors, tubes, transistors, rectifiers, condensers, tools, tuners, etc. etc. HYTRON HUDSON, Dept. RE 2201 Bergenline Ave., Union City, N.J. 07087

LOGIC Probe with LED display \$20.00 post-paid U.S. Order from UTI POB 252 Waldwick, N.J. 07463

CANADIAN surplus catalog \$1.00. ETCO ELECTRONICS, 464B McGill, Montreal, Canada

SEMICONDUCTOR and parts catalog. J. & J. ELECTRONICS, Box 1437, Winnipeg, Manitoba, Canada

ELECTRONIC ignition—various types, information 10¢. ANDERSON ENGINEERING, Epsom, N.H. 03239

JAPANESE new products monthly! \$1.00. Refundable. DEERE, P.O. Box 9308, North Hollywood, CA

## INVENTIONS & PATENTS

INVENTIONS Wanted. Patented; unpatented. GLOBAL MARKETING, 2420-AE 77th Ave., Oakland, Calif. 94605

## BUSINESS OPPORTUNITIES

START SMALL HIGHLY PROFITABLE ELECTRONIC PRODUCTION IN YOUR BASEMENT. INVESTMENT, KNOWLEDGE UNNECESSARY. Postcard brings facts. BARTA-REI, Box 248, Walnut Creek, Calif. 94597

## PLANS & KITS

ELECTRONIC ORGAN KITS, KEYBOARDS for music synthesizers and organs. Independent and divider tone generators, diode keyer systems. I. C. circuitry. Many components. 25¢ for catalog. DEVTRONIX ORGAN PRODUCTS, Dept. B, 5872 Amapola Drive, San Jose, Calif. 95129

CONVERT any television to sensitive big-screen oscilloscope. Only minor changes required. No electronic experience necessary. Illustrated plans \$2.00. RELCO—A25, Box 10563, Houston, Tex. 77018

## SOLID STATE TV MODULES

XL 100 • GE • QUASAR • DURAMODULE  
• NEW • EXCHANGED LIST \$2.00 P.P.  
ENCYCLOPEDIA OF MODULAR T.V. — PARTS LIST TROUBLE CHART  
DWGS — PAYS FOR ITSELF ON FIRST CALL \$13.95 POST PAID

Automatic Service Co. (201) 838 7077  
22 GORMLY RD.,  
BUTLER, NEW JERSEY 07405

## A NEW INSTRUMENT TO USE WITH YOUR SCOPE



### MULTITRACER

Use with your present Oscilloscope to trace Resistors, Capacitors, Transformers, Diodes, Transistors, Generators, Triggers, most Semiconductors, IC's, etc. Also shows continuity, in-circuit and go/no-go checks. Complete with diagrams and instructions. No internal scope connections. For medium or small production runs or for hobbyist, experimenter, engineer, or ham.

ONLY \$19.95—CHECK OR MONEY ORDER  
WHY PAY MORE?

BOX 14, LESCO ELECTRONICS, SKOKIE, ILL. 60076

## REBUILD YOUR OWN PICTURE TUBES?

With Lakeside Industries precision equipment, you can rebuild any picture tube!

For complete details, send name, address, zip code to:

LAKESIDE INDUSTRIES  
3520 W. Fullerton Ave.  
Chicago, Ill. 60647  
Phone: 312-342-3399



## F.C.C. EXAM MANUAL

The Original Test-Answers exam manual that prepares you at home for FCC First and Second class licenses. Includes Updated multiple choice tests and key Schematic diagrams. PLUS - "Self-Study Ability Test." -- ONLY: \$9.95 Postpaid.

COMMAND PRODUCTIONS P.O. BOX 26348 E  
RADIO ENGINEERING DIVISION SAN FRANCISCO, CALIF. 94126

## HIGHLY PROFITABLE ONE-MAN ELECTRONIC FACTORY

Investment unnecessary, knowledge not required, sales handled by professionals. Ideal home business. Write today for facts! Postcard will do. Barta-DRA, Box 248, Walnut Creek, CA 94597.

## BUILD A "SPACE-AGE" TV CAMERA!!

ONLY KNOWN SOLID-STATE CAMERA IN KIT FORM! Also available factory assembled. Ideal for experiments, industry, education, etc. High quality, performance backed by over seven years of lab and field testing. Fully Guaranteed. Completely self-contained. Connects to any TV set without modification. Easy-to-follow assembly manual. Model XT-1A, Series D complete with vidicon \$169.95. Kit available in USA & Canada (first vidicon tube \$116.95). Many other kits, parts and plans also available.

PHONE OR WRITE FOR CATALOG... DIAL 402-987-3771

BOX 453-RE ATV Research DAKOTA CITY, NEBR. 68731

## IC PRICES SLASHED

### FACTORY FIRSTS

NATIONALLY KNOWN BRANDS SATISFACTION GUARANTEED

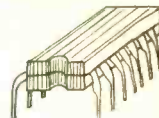

DIGITAL TTL	
7400N	22¢
7401N	22¢
7402N	22¢
7403N	22¢
7404N	24¢
7410N	22¢
7420N	22¢
7430N	22¢
7440N	22¢
7441N	\$1.20
7442N	\$1.15
7447N	\$1.02
7451N	22¢
7453N	22¢
7454N	22¢
7472N	35¢
7473N	46¢
7474N	42¢
7475N	72¢
7476N	50¢
7486N	52¢
7490N	72¢
7492N	72¢
7493N	72¢
7495N	\$1.05
74107N	47¢
74121N	51¢

"5% OFF TTL IC PRICES AT 100 PCS TTL ICS MIXED.

## LINEAR INTEGRATED CIRCUITS

709C TO-5 DIP or MINIDIP	38¢	10/\$3.50
710C TO-5 or DIP	38¢	10/\$3.50
723C TO-5	90¢	10/\$8.25
741C TO-5 DIP or MINIDIP	40¢	10/\$3.70
748C TO-5 DIP or MINIDIP	43¢	10/\$3.95
558 (DUAL 741) MINIDIP	75¢	10/\$6.75
558 (DUAL 741) TO-5	90¢	10/\$8.25
LM309K TO-3	\$2.25	5/\$10.00

## GENERAL PURPOSE SILICON TRANSISTORS

2N3638 PNP	20¢	10/\$1.65	100/\$15.00
2N3638A PNP	22¢	10/\$1.80	100/\$16.50
2N3641 NPN	23¢	10/\$2.00	100/\$17.50
2N3643 NPN	23¢	10/\$2.00	100/\$17.50
2N5133 NPN	15¢	10/\$1.25	100/\$10.00
2N5134 NPN	15¢	10/\$1.25	100/\$10.00
2N5137 NPN	18¢	10/\$1.50	100/\$13.65
2N5138 PNP	15¢	10/\$1.25	100/\$10.00
2N5139 PNP	15¢	10/\$1.25	100/\$10.00

## 1 AMP SILICON SUBMINIATURE RECTIFIERS

1N4005 600PIV	10/\$1.00	100/\$7.50	1000/\$60.00
1N4007 1000PIV	7/\$1.00	100/\$9.95	1000/\$84.00

## DTL INTEGRATED CIRCUITS DIP PACKAGE

930, 936, 945, 946 and 962... Specify number of each type 20¢ 10/\$1.75 100/\$16.00

## SILICON SIGNAL DIODES

1N4148 (1N914 equiv.) ....20¢/1.00, 100/\$4.00

## RTL INTEGRATED CIRCUITS TO-5 EPOXY PACKAGE

uL900, uL914 and uL923... Specify number of each type 5/\$1.00 100/\$15.00

## MOLEX IC SOCKET PINS

100/\$1.00 200/\$1.80 300/\$2.60 500/\$4.20  
700/\$5.80 1000/\$8.20 ea addn 1000/\$7.50

## READOUT TUBES

5 Volt 7 Segment Readout Tube \$2.95. Counting and Display Kit (Readout Tube +7490+7475+7447) \$5.25, 3 Kits for \$15.00

## ½ WATT 10% RESISTORS

Pick Values 4¢ 25/75¢ 100/\$2.50 500/\$11.25

Free Catalog—Large Quantity Discounts—Orders Less Than \$10.00 Add 25¢—Others Postpaid

## DIGI-KEY PRICE PACESETTER FOR QUALITY IC'S

BOX 126H THIEF RIVER FALLS, MN56701

Circle 104 on reader service card

Fight Mental Illness



Support your Mental Health Association

## WORLD FAMOUS Dollar Stretchers

- 1-2N3055 npn, 100w 15A, TO-3, transistor \$1
- 2-2N3572 EPOXY, TO-92, pnp transistor \$1
- 3-ERPO TRIGGER DIODES for SCRS & Triacs \$1
- 4-2.5 AMP 1000 PIV ITR, silicon epoxy rectifiers \$1
- 5-VARACTOR DIODES, 10pf, 20pf, 30pf, 40pf, 50pf \$1
- 6-FET'S 2N3847 N channel 500uhm, TO-92 plastic \$1
- 7-90 WATT PNP, 15A, 2N2612, TO-3, silicon \$1
- 8-2N3847 npn, silicon, 85 watts, Vee 60, stud case \$1
- 9-2N1212 npn, silicon, 85 watts, Vee 60, stud case \$1
- 10-1N914 fast switch diodes, silicon 4 nanosecond \$1
- 11-2N404 germanium pnp, TO-5 chrome case \$1
- 12-6 AMP TRIAC 200 PRV, TO-5 \$1
- 13-GE MICRO MINI RECTIFIERS, silicon, porcelain to 1KV \$1
- 14-RECTIFIERS & ZENERS, 1W & 1A, bullets, assorted volts \$1
- 30-WORLD'S SMALLEST RECT., & zeners, 1W, assorted volts \$1
- 1-FAIRCHILD 2N3919 80mc, 15W, npn, 10A, TO-66 \$1
- 2-2N3638 PNP, silicon, TO-5 plastic transistors \$1
- 3-2N3641 NPN, silicon, TO-5 plastic transistors \$1
- 4-2N4269 Nixie tube driver transistors 100V, npn \$1
- 2-FET'S 2N3085 N channel, 10,000 umho TO-18 transistors \$1
- 2-PUTS, prog. uni-transistors, similar to GE-D13T \$1
- 2-2N2608 P channel, 2500 umho, TO-18 \$1
- 2-2N3819, Texas, N channel, 6500 umho, TO-18 \$1
- 6-TRIGGER DIODES, for SCRS only, axial leads \$1

### ALPHA-NUMERIC 7-SEG. READOUTS

- MINI-7 3 for \$6.
- MINI-7 1.75 x 1.7 x .380 x .570 1.5V AC/DC 42 mils
- SLIM-7 1.8 x 0.375 x .40 x 2.1 1.5V AC/DC 42 mils

MINI-7 All have O-B numerals, decimals and letters. SLIM-7

- 3-2N2646 UNIUNCTIONS, plastic transistors, Texas \$1
- 5-2N1107, GE, most commonly used pnp, germanium \$1
- 3-3-AMP 1000 PIV epoxy bullet, silicon rectifiers \$1
- 50-SILICON, glass rectifiers, computer, axial leads \$1
- 50-GERMANIUM, glass rectifiers, signal, axial leads \$1
- 5-2N170, GE, RF, germanium, npn, transistors, TO-22 \$1
- 10-1-AMP 1000 PIV, epoxy, submini, silicon rectifiers \$1
- 3-500 MW ZENERS, axial lead, 9, 10, 12V rectified \$1
- 2-2N3055, HOBBY, 40W npn silicon transistors, TO-3 \$1
- 2-2N155, HOBBY, 10W pnp germanium transistors, TO-3 \$1
- 3-50 AMP SILICON RECTIFIERS, silicon, 6, 12, 24 volts \$1
- 5-2N1038, TEXAS, germanium pnp, 20 watts, TO-5, w/sink \$1
- 2-2N3054 hobby, npn, TO-66, silicon, 30W, 30mc \$1
- 10-SCRS, germanium, TO-5, TO-18, TO-66 \$1
- 30-3-AMP RECTIFIERS, silicon, epoxy, assorted V, axial \$1
- 5-SN7441M, hobby, BCD-to-Nixie driver IC, DIP \$1
- 10-LINEAR AMPS, 709, 710, 711, 741, TO-5 \$1
- 10-709 LINEAR AMPS, 741's too, DIP's \$1
- 5-HOBBY MEMORY CELLS, 5N7480, up to 16-cell, DIP \$1
- 10-709, 710, 711 LINEAR AMPS, brand new, flat pak \$1
- 2-2N5296 38-WATT PNP PLASTIC TRANSISTORS, for any 540 \$1
- 2-2N6109 40-WATT PNP PLASTIC TRANSISTORS, for any 540 \$1
- 10-RCA CA-3000 OP AMPS, TO-5 case \$1
- 5-723 VOLTAGE REGULATORS, TO-5, TO-18 case \$1
- 10-1000 HF OSLINGTON transistors, TO-18 case \$1
- 1-2N5038 HI PWR plastic tube 1000 vceo, 7 amp 85 watts \$1
- 2-2N5296 HOBBY 35 watts, plastic powers NPN \$1
- 2-2N6109 HOBBY 40 watts, plastic powers PNP \$1
- 5-PLASTIC 35W powers, npn, silicon, hobby 2N6121 \$1
- 5-PLASTIC 35W powers, pnp, silicon, hobby 2N6124 \$1
- 2-MOS FETS, DUAL GATE, 3N182, TO-18, RCA \$1
- 2-MOS FETS, DUAL GATE, N chan., 3N187-1, TO-18, RCA \$1
- 2-MOS FETS, DUAL GATE, N chan., 3N140-1, TO-18, RCA \$1
- 4-RCA 2N3600 NPN, UHF transistors, tv-fm, TO-18 \$1

\* Untested guaranteed satisfaction

### LED- PHOTO-SOLAR 'DOLLAR STRETCHERS'

- 3-"LEDS", visible, micro-miniature, axial leads \$1
- 2-"LEDS", infrared, jumbo, TO-18 \$1
- 2-"LEDS", visible, jumbo, red, TO-18 \$1
- 2-"LEDS", visible, parallel resistor, RCA \$1
- 1-PHOTO TRANSISTOR, with darlington amp filter, lens \$1
- 1-PHOTO TRANSISTORS, with darlington amp, 2N5777, GE \$1
- 4-PHOTO CELLS, Calex, pancake, 30K TO 90 ohms \$1
- 1-SOLAR MISC, various, ass't sun power circuits \$1
- 2-SILICON SENSORS, TEXAS, 1/8" Matchless, visible \$1

### SUPER ECONOMY \$1 PARTS "DOLLAR STRETCHERS"

- 30-POWER RESISTORS, 3-to-25w, square, vitreous, asst vals \$1
- 6-REED SWITCHES, 2" long, fastest mech. switch \$1
- 10-MICRO PIV SWITCHES, 1" long, transistor work \$1
- 10-TRANSISTOR SOCKETS, for pnp-npn trans, powers too \$1
- 1-\$25 SURPRISE PAK, resistors, caps, transistors, etc. \$1
- 50-TERMINAL STRIPS, 1-to-8 screw & tie lugs \$1
- 40-RADIO & TV NOBS, asst shapes, colors, styles \$1
- 30-SQUARE POTTS, 100, 250, 5K, 10K, 25K, 50K, snap-in \$1
- 75-PRE-FORMED DISCS, condensers, printed circuit \$1
- 10-PHONO PLUG-AND-JACK SETS, tuners, amps, double too \$1
- 10-KODAK LENSES, piano convex, concave, convex, mirror \$1
- 60-TUBE SOCKETS, receptacles, plugs, audio, etc. \$1
- 100-REFORMED RESISTORS, 1/2 watt, printed ckt \$1
- 30-DIPPED SILVER MICAS, pop valves, silver, too \$1
- 50-COILS & CHOKES, if, rf, ant, peaks, osc, parasitic \$1
- 10-IC SOCKET-ADAPTERS, TO-5 DIPs, flat, handy \$1
- 60-PRECISION RESISTORS, 1/8, 1/2, 1 & 2W, 1% asst vals \$1
- 6-TUBULAR CONDENSERS, to 5mf, to 1kV, mixed too \$1
- 10-SUBMINIATURE IFS, 5, 455 kc, 100K, 200K, 500K \$1
- 10-TUBULAR ELECTROLYTICS, to 100mf, for ac/dc sets, etc. \$1
- 15-NE-2 NEON BULBS, for 110vac, 100's of projects \$1
- 30-POLYSTYRENE CONDS, finest caps made, asst. values \$1
- 10-FINE PNT SWGCHES, 110vac, micro, rotary, thermal, slide, \$1
- 10-VOLUM CONTROLS, 100k, 250k, 500k, 100k w/switch \$1
- 40-MICRO MINI RESISTORS, 1/8w, 100 ohm to 1meg, 5% \$1
- 30-MOLEDOE CONDENSERS, upright, & axial, to 1mf to 1KV \$1
- 50-ONE WATT RESISTORS, 1% & 5% AB's too, 100 to 1 meg \$1
- 10-TRANSISTOR ELECTRO'S, 5mf, to 300mf, upright too \$1
- 10-UPRIGHT TRANSISTOR ELECTRO'S 5mf to 300mf \$1
- 60-CERAMIC CONDENSERS, 100mf to .04, npo's, discs \$1
- 40-MICRO-MICRO-MINI CONDENSERS, to .05mf Cerafil \$1
- 5-IBM COMPUTER BOARDS, trans, caps, res, coils, etc. \$1
- 10-ELECTROLYTIC CONO'S, FP's, & tubular, 2 & 3 sect. too \$1
- 6-TRIMMER POTTS, 500, 2K, 5K, 10K, 25K, 50K, snap-in \$1
- 60-HI-Q RESISTORS, carbon 1/8, 1/4, 1/2, 1, 2W 5% \$1
- 50-DISC CAPACITORS, 100mf to .05, npo's, hi-Q, to 6KV \$1
- 50-MICA CAPACITORS, to .01, to 1KV, silver too, asst \$1
- 35-TWO WATTERS, resistors, carbon, metal-film, 5% asst \$1
- 1-MICRO POTS, knob, snap-in, 1/5W, 200, 500, 100K, 1meg \$1
- 10-PRINTED CIRCUIT PARTS, resistors, trans, etc. \$1
- 30-YELLOW PACKET MYLARS, assorted values & sizes \$1
- 10-POWER TRANSISTOR SOCKETS, for TO-3, asst types \$1
- 3-"MINIATURE" MOTORS, shaft, 3-12vdc, high speed \$1
- 64-PLASTIC TRANSISTORS, 1/2 watt, printed circuit \$1
- 2-CRAMER 28 VAC, 500, 500, 500, 500, 500, 500 \$1
- 100-PC PARTS, BOURNS pots, transistors, diodes, etc. \$1
- 2-110 VAC MERCURY SWITCHES, Dress-Ht, 1" long \$1
- 1-HELICAL FLASH TUBE, retriggerable, gas, strobe, etc. \$1
- 1-MICRO-MINI METER, 1/2" dia., "S" meter, etc. \$1
- 3-MINI MOTORS, sealed, 1/2 to 12VDC, hi-speed \$1

**PHILCO-FORD** Replacement for tape recorder, PA systems, audio amps, 200 ohms, 6-ft. cord and mini mike plug, 200-5000 Hz. Wt. 6 oz. Fits in "palm of hand."

**\$1.98 DYNAMIC MIKE**

2 1/2" x 1 1/2" x 3/8"

Designed by our Scientific Device engineers as the most advanced digital timing device in the consumer "time" field. One radio-and-TV station engineer tells us, "Not a change of a second in 3 months. It is so accurate we use it as our standard. KRONOS KR100 Series, in the new sleek all-purpose walnut-and-black modern design cabinet, enhances any office, home, den, etc. It becomes a "visible-action conversation piece" wherever it is placed. Has modern LSI National Clock Chip, and 8-page brochure chock-full with pictorials and easy-to-understand, step-by-step instructions. This kit is COMPUTER SIMPLIFIED making do-it-yourself easy! Other features include 3 setting controls, 1 hour per second, 1 minute per second, and hold button. Easy-to-change from 12 to 2 hours, 4 to 8 digits, 50 to 60 Hz operation. Your choice of 4 different type readout systems:

- MAN-3 Type LED, MAN-1 Type LED (the larger character size), 6-Digit Burroughs B-5750 Nixie Tube, and Elin 7-Segment Nixie Type Tubes. Kit includes genuine POLAROID filter. Buy 3 - Take 10%

Size of cabinet: 6" x 5 1/2" x 6" deep

**KRONOS** Only \$57.  
With Cabinet

**'TIME STANDARD' CHRONOMETER**

- KR101 7-Segment MAN-3 Type LED, 6 Digits \$57.00
- KR102 7-Segment MAN-1 Type LED, 6 Digits \$79.95
- KR103 6-Digit Burroughs B-5750R Nixie Tubes \$70.00
- KR104 Elin 7-Segment Nixie Type Tubes \$70.00

**Largest Selection TTL IC's**

Brand New "DIP" Packages Order by type number! Spec sheets on request "ONLY"

Buy 3 for more 10% discount

NT7400 \$25	SN7437 .50	SN7476 .44	SN74151 1.13
SN7401 .25	SN7438 .51	SN7480 .65	SN74153 1.25
SN7402 .25	SN7441 1.30	SN7481 1.10	SN74154 1.95
SN7403 .25	SN7442 1.12	SN7482 .88	SN74155 1.79
SN7405 .28	SN7443 1.21	SN7483 1.25	SN74156 1.39
SN7406 .45	SN7444 1.21	SN7486 .49	SN74157 1.25
SN7407 .45	SN7445 1.21	SN7489 3.50	SN74158 1.48
SN7408 .29	SN7446 1.50	SN7490 1.00	SN74160 1.79
SN7410 .29	SN7447 1.50	SN7491 1.10	SN74161 1.79
SN7411 .25	SN7448 1.25	SN7492 .71	SN74162 1.79
SN7413 .75	SN7449 .25	SN7493 .71	SN74163 1.79
SN7414 .75	SN7450 .25	SN7494 1.10	SN74165 3.50
SN7417 .48	SN7453 .25	SN7495 .95	SN74180 1.10
SN7421 .25	SN7454 .25	SN7496 1.10	SN74181 4.50
SN7426 .32	SN7455 .25	SN74107 .49	SN74182 1.50
SN7430 .25	SN7460 .21	SN74121 .49	SN74185 2.50
SN7432 .25	SN7470 .39	SN74122 .65	SN74189 1.75
	SN7472 .32	SN74123 .99	SN74193 1.75
	SN7473 .48	SN74141 1.49	SN74195 1.19
	SN7474 .39	SN74145 .25	SN74198 2.65
	SN7478 1.00	SN74150 1.25	SN74199 2.65

Factory Marked!

**GIANT SALE ON NATIONAL 'IC'S' Discount**

Buy 3 - Take 10%

Type	Description	Buy 1 @
DM8091	Tri-State Quad Buffer	\$1.00
DM8093	Tri-State Quad Buffer	1.00
DM8094	Tri-State Quad Buffer	1.00
DM8200	4-Bit Comparator	1.50
DM8210	8 Channel Switch	1.00
DM8220	Parity Generator Checker	1.00
DM8223	Programmable ROM	8.88
DM8250	Binary to Octal Decoder	1.00
DM8281	Preset Binary Counter	1.19
DM8680	Parity Divide by 12	1.18
DM8502	Same as 74107	.41
DM8520	Module Divide by 2-16	1.50
DM8555	Tri-State Preset Counter	1.95
DM8680	Binary Counter	1.00
DM8900	Dual Voltage Translator	1.00
DM8630	Dual Diff. Line Driver	1.00
DM8645	Same as SN7445	1.45
DM8645	Same as SN7446	1.45
DM8680	Hi Amp, 7-Seg. Dec. Driver	1.95

**"How's Your MEMORIES For 1973?"**

1101	256 Bit RAM MOS	\$3.50
1101	1024 Bit RAM MOS	8.50
2513	Character Gen. ROM	12.50
7489	64 Bit RAM TTL	3.50
A223	Programmable ROM	8.50
8224	Programmable ROM	12.50
MMS260	1024 Bit RAM	8.88
4000	64 Core Memory Plane	4.95

**LED READOUTS \$2.95**

Buy 3 - Take 10%

This display is excellent for small portable electronics, such as DVN's, calculators, etc. Equivalent to Monsanto MAN 3A. Operates from 5V, 20 milliamperes, with 47 ohm dropping resistor.

**Potter & Brumfield KAP RELAYS**

Your choice 3 for \$7.50 \$2.98

115 VDC 3PDT	\$2.98
12 VDC 3PDT	2.98

**NATIONAL "OP" AMPS Buy any 3**

Type	Description	Buy any 3
LM-202	2 Watt amplifier	\$1.95
LM-300	Super 723 V. regulator TO5	1.49
LM-301	Hi-performance amp	.49
LM-302	Neg. voltage regulator TO5	1.49
LM-304	Neg. voltage regulator TO5	1.49
LM-305	Pos. voltage regulator TO5	1.49
LM-307	Super 741	.59
LM-309H	Super gain op amp TO5	1.98
LM-309K	SV 1 amp V. regulator TO5	1.98
LM-380	Dual peripheral driver TO5	.88
LM-379	AGC squash op amp TO5	1.49
LM-373	AM-FM 556 if strip TO5	3.75

**MAGIC "SOUND TRIGGER" \$1.98**

Unique Scientific Device, "hand claps", sensitizes crystal mike amplifier, triggers SCR. Needs only 3 to 6vdc. Use as burglar alarm, intrusion device. Use with photo cell, triggers SCR's, relays, LED's. Even fiber optic light pipe may be used. With hand booklet.

**NIXIE TUBE SALE \$2.50**

Burroughs B7971, 0-to-U, A-to-Z, 2 1/2" high characters, 170V

**EPOXY SILICON BRIDGE RECTIFIERS**

PIV 2 Amp	3 Amp	5 Amp
100	100	100
200	200	200
400	400	400
800	800	800
1600	1600	1600

**LOW PRICES ON 'TRIACS'**

\* Two SCRs in one case! \* Most complete listing!

PRV	3 amp	6 amp	10 amp	15 amp	25 amp
.50	\$2.22	\$3.38	\$4.45	\$5.65	\$8.85
1.00	.35	.52	.64	.85	1.08
200	.65	.72	.88	1.25	1.45
300	.79	.85	1.18	1.45	1.85
400	.92	1.15	1.38	1.85	1.95
500	1.25	1.39	1.55	2.25	2.45
600	1.50	1.69	1.95	2.65	2.85

3 & 6 amp TO-5, 10 amp TO-66, 15 & 25 amp stud.

**STEREO PREAMP 1-WATT AUDIO AMP**

Dual 739-739 8-transistors per channel. 30K in. imp. for phono-tape. 20-20,000 mc. DIP, Fairchild. Choose Any 1.95

8-transistors in TO-5 case. 400K in. imp. Westinghouse W334, TO-5. 3 for \$4.50

**INTEGRATED CIRCUIT SOCKETS**

Buy Any 3 - Take 10% Discount!

14-Pin, dual in line	\$.45
16-Pin, dual in line	.50
TO-5, 8 or 10 pins	.29

**LINEAR Op Amps**

Type	FACTORY TESTED	FACTORY MARKED
531	Hi slow rate op-amp TO-5	\$2.50
532	Micro power 741 (A)	2.50
533	Micro power 709 TO-5	2.50
536	FET input op amp TO-5	3.95
537	Precision 741 TO-5	2.50
540	70W pwr driver amp TO-5	2.04
550	Precision 723 voltage reg. (DIP)	1.17
555	Timer 2 microseconds to 1-hour (A)	1.19
558	Dual 741 (A)	.88
560	Phase lock loops	3.25
561	Phase lock loop	3.25
562	Phase lock loop	3.25
563	Phase lock loops (A)	3.25
566	Function generator (MINI DIP)	3.25
567	Tone decoder (A)	3.25
595	Four quadrant multiplier	3.10
702C	Hi-gain, DC amp, TO-5	4.4
703C	RF-amp, 1 & 1/2 chs, TO-5	1.00
709C	Operational amp (A)	.39
710C	Differential amp (A)	.39
711C	Opal diff. comp (A)	.39
723C	Voltage regulator (A)	.45
741C	Frequency comp 709 (A)	.99
741CV	Frequency comp 709 [mini DIP]	.99
747C	Dual 741C, (A)	1.25
748C	Freq. adpt. 741C (A)	.44
709-709	Dual 709C (DIP)	1.00
739-739	Dual stereo preamp	1.98
741-741	Dual 741C (A)	1.00

(A) TO-5 or DIP dual in line pak

**POLY PAKS**

P.O. BOX 842R, LYNNFIELD, MASS. 01940

Terms: add postage, cod's 25%. Rated net 30. Phone Orders: Wakefield, Mass., (617) 245-8829. Retail: 16-18 Del. Carline St., Wakefield, Mass. (on Water Street) C.O.D.'S MAY BE PHONED

15¢ CATALOG on Fiber Optics, IC's, Semi's, Parts



# EXCLUSIVE ECONOMY-PACKED DOUBLE BONUS Sale

BONUS #1  
**Free \$25**  
Add 25¢ for handling PAK

WORTH OF  
ICs, DIODES, TRANSISTORS, RECTIFIERS, ZENERS, CONDENSERS, KNORNS, ETC.

PLUS CHOOSE  
ANY ITEM  
FOR LESS  
FREE

**BOTH FREE WITH ANY \$10. ORDER**

## PHILCO 11 TRANSISTOR AM RADIO CHASSIS

Use as:  
● Mike amplifier  
● Phono amplifier  
● Tape amplifier  
● Covers 555 Kcs to 1500 Kcs Broadcast band

**Only \$5.95**

AC or DC

One of the most versatile AM Radio and multi-purpose amplifiers we have seen at Poly Paks famous "Economy" price. Measures only 4 1/2" x 3" x 2" high. With tuning capacitor, IF circuitry, loostick, ant. volume control with switch, AC and phono-mike jacks. Separate switch for changing from AM radio to amplifier. Uses either 110V plug-in adapter (not with unit) and a 9-volt battery power. Exceptional sensitivity and power. Feeds into 16 ohm speaker. Complete with spec sheets, diagrams, and hookup ideas.

**BUY 2 FOR STEREO**

## 8 TRANSISTOR AMPLIFIER CHASSIS

**Only \$3.95**

Same as above, except no AM radio section. Completely wired! With built-in preamp, mike, phono and tape inputs. Color-coded wires with diagram and hookups. Works off 9VDC transistor battery. Excellent fidelity. Shpg. wt. 1 lb.

## AC-DC CHARGER-CONVERTER

Only \$1.98

Converts above 11-and-8-transistor chassis from 9VDC to 110VAC. Easy to hook in. Use as "NICAD" battery charger too (with instructions). Size: 2 1/4" x 1 1/4". 1-lb. S-IN. "HI-FI" PM SPEAKER — Only \$1.98

5-ounce ceramic, cylindrical magnet. Twin voice coil, 4 and 8 ohms. 20-16,000 cycles. Shpg. wt. 3 lbs.

## TEXAS 4-WATT AUDIO AMPLIFIER

3 for \$3.95

Type SN7602A. Good up to 70 Hz. 4 W. into an 8-ohm load. High input impedance. VCC 9V to 24 DIP pak with heat sink. 15 transistors, 5 diodes.

## BRAND NEW LOWEST PRICES GENERAL ELECTRIC 3-WATT AUDIO AMP

Delivers 3.5 watts continuous, 10 watts peak. With heat sinks; micro-mini size: 3/4" x 1/2" x 1/2". 9 to 30V supply. High sensitivity, 8 to 16 ohms.

**Only \$2.95**

## IT'S NEW! 12-DIGIT "CALCULATOR ON A CHIP"

3 for \$35

Sorry, can't name U.S. maker! Type SD5001. Similar to Mostek 6012. Outperforms Texas 8-digit TMS-1802. Features: 40-pin DIP; not 5, not 3, but only single "calculator chip"; 12-digit capacity; adds, subtracts, multiplies, divides, fixed point (0, 2, 3 or 4 decimal places), chain operations, leading zero blanking, 7-segment decoded display output, overflow lockout, and negative sign output. Drives incandescent, fluorescent, Nixies, and LED readouts, complete with instruction booklet.

## RADIATION SURVEY INSTRUMENT

**\$9.95**

Wt. 3 lbs; size 6x4x8 1/2".

## Victoreen 710B, measures Gamma radiation from 0.1-50 roentgens/hr.

This surplus C-D meter is new, guaranteed and comes with a complete manual of instructions, theory of operation, circuitry, detailed parts list. The 20 ga meter is calibrated in roentgens per hour, indicating the presence of gamma radiation. Three multiplier scales (Victoreen 100,000 meg; 10,000 meg; 1,000 meg decade) matched within ±2%

## LED READOUTS

**4.50**

3 for \$12.

0.9 plus letters, for SN7446 or SN7447. Snap in 14-pin DIP socket. 3/4" x 3/8" characters; 1/4" x 1/8" characters; 1/8" x 1/8" characters; 20-mils per seg. characters; 1/8" x 3/16" Famous MAN-1 type. Sockets .50 ea.

## Lowest prices on COUNTING SYSTEM

Includes SN7441, SN7476, SN7490, 0 to 9 National Nixie tube, sheets.

**\$4.50** 3 for \$12.00

## ALLEN BRADLEY 'MICRO-POTS'

Type G, 1/2" dia. x 1/2" high. Mounts 1/4" hole, with shaft, linear, immersion-proof high freq.

75 Ohms	2.0K	7.0K	25.0K	2 for \$1
100	2.5K	10.0K	75.0K	
500	5.0K	20.0K	100.0K	5 Meg

We stock Locknut Bushing & Screwdriver types at same low prices.

## ALLEN BRADLEY'S 'TRANSISTOR POTS'

Type F. Screwdriver adjust.

Ohms	250	1.0K	7.5K	25.0K	100K	Any
100	500	5.0K	20.0K	100.0K	250K	2 for \$1
200	750	5.0K	20.0K	75.0K	1.0M	

Retail: 16-18 Del Carmine St., Wakefield, Mass.  
Terms: add postage, cod's 25%. R.O.'s add 30%  
Phone Orders: Wakefield, Mass. (617) 245-3829  
C.O.D.'S MAY BE PHONED IN

**POLY PAKS** P.O. BOX 942R  
Lynnfield Mass. 01940

## BUILD 32-FUNCTION DIGITAL COMPUTER

24-PIN IC, 12 TRANSISTORS, COMPLETE INSTRUCTIONS, \$15.25. ELECTRONETICS, Box 278, Cranbury, N.J. 08512

FREE catalog. Most unusual electronic kits available. Music accessories, Surf, Wind Synthesizers, Wind Chimes, many others. PAIA ELECTRONICS, Box B14359, Oklahoma City, Okla. 73114.

## ELECTRONICS ENGINEERING & INSTRUCTION

### LOGIC NEWSLETTER, design and construction.

Sample copy \$1.00. LOGIC NEWSLETTER, Box 252, Waldwick, N.J. 07463

### SHORTCUTS to success! Highly effective, profitable short courses. (75 choices). Study at home. Diploma awarded. Our 27th year. Free literature. CIEE-E, Box 10634, Jackson, Miss. 39209

### TV TUNER repairs—Complete course details. 12 repair tricks. Many plans. Two lessons, all for \$1. Refundable. FRANK BOCEK, Box 3236 (Enterprise), Redding, Calif. 96001

### AVIATION ELECTRONICS TECHNICIAN—Prepare for exciting career in new field of "Avionics". Train at nation's largest aeronautical school. Indicate if eligible G. I. Benefits. SPARTAN AIRSCHOOL, International Airport, MNW, Tulsa, Okla. 74151

### HIGH school diploma for adults. Earn State Diploma. Accepted by Civil Service, business, colleges. Low cost. No tedious study. Money-back guarantee. Details: H-S PROGRAM, Suite 2507, 1221 Avenue of Americas, New York, N.Y. 10020

# Give Happiness The United Way

## STAR-TRONICS

### INDUSTRIAL AND GOVERNMENT ELECTRONIC SURPLUS

PARTS & PIECES FOR SCHOOLS, SHOPS, HAMS & HOBBYISTS

SEND FOR OUR LATEST ALL DIFFERENT MONTHLY PICTURE CATALOG. NOW!

**Box 17127, Portland, Ore. 97217**

## TRANSISTOR TESTER

### "IN CIRCUIT"—Model 85

**\$19.95 Prepaid**

Places transistor into actual operation. Operates upon contact. Clear speaker tone—no visual observations to make. Tests transistors in or out of the circuit. Money back guarantee.

Extender Cable Included with Tester

**UNITED SALES, DEPT. 8690 BRIGHTWOOD, WASHINGTON, D.C. 20011**

## YEATS appliance dollies

### MOVE 'EM EASY with a YEATS dolly

NO LIFTING

ROLLS UP & DOWN STAIRS

DeLuxe Model No. 14 \$89.50  
ORDER YOURS TODAY! FREE illustrated brochure

**Yeats Appliance Dolly Sales Co.**  
1307 W. FOND DU LAC AVE.  
MILWAUKEE, WIS. 53205

## CALCULATOR CHIP—40 PIN

12 DIGIT - ADD - SUBTRACT - MULT. - DIVIDE  
COMPLETE DATA FURNISHED

**\$10.75**

## MONSANTO MAN-1 7-SEGMENT LED DISPLAY

**\$4.00**

## 8223 FIELD PROGRAMABLE ROM

256 BIT WITH 32 8-BIT WORDS  
OPTIONAL CUSTOM PROGRAMMING

**\$8.00**  
**\$5.00**

## 1101 256 BIT MOS RAM

**\$3.90**

## PHASE LOCKED LOOPS

565 FUNCTION GENERATOR **\$3.25**  
566 TONE DECODER **\$3.25**  
567 PHASE LOCKED LOOP **\$3.25**

## LM-309-K 5 VOLT 1 AMP REGULATOR

SHORT CIRCUIT PROTECTED TO-3

**\$2.25**

## LM-308 ULTRA HIGH INPUT IMPEDANCE OP-AMP 10 MEGOHMS!!

CAN USE WITH JUST A SINGLE 5V. SUPPLY.

**\$2.95**

## LM-380 2 WATT AUDIO AMP.

**\$2.25**

DM 8200	4 Bit Magnatude Comparator	\$1.90
	Indicates Less Than, More Than, or Equal	
DM 8281	Presetable 4 Bit Counter	\$1.05
DM 8520	Modulo N Divider	\$1.90
DM 8570	8 Bit Serial-To Par. Shift Reg.	\$1.90
DM 8590	8 Bit Par to Serial Shift Reg.	\$1.90
DM 8601	Retrig. Mono. Multivibrator	\$1.20
DM 8880	7 Segment New Decoder Driver	\$2.50
DM 8210	8 Channel Digital Switch	\$1.50
DM 8551	Tri-State 4 Bit Latch	\$1.10
DM 8830	Dual Differential Line Driver	\$1.25
DM 8820	Dual Line Receiver	\$1.25

7400	7401	7402	7403	7404	7405	7408	\$2.1
7410	7420	7430	7440	7450	7454	7460	

7441	7442	7448	7495	7496	1.00	7446	7447	1.10
7472	7474	.35	7473	7476	.40	7475	7490	7493
7483	1.05	7486	.45	74192	74193	1.55	7489	3.40
74154	1.50							

## LOW POWER TTL—ONE-TENTH THE CURRENT

74L00	74L04	74L08	74L10	74L20	74L30	74L51	.40
74L73	74L74	.90	74L90	74L93	2.00		

All Shipments By First Class Mail—We Pay.

**JTM ASSOCIATES**  
P. O. BOX 843 MANCHESTER, MO. 63011

Circle 106 on reader service card

# FREE Catalog

OF THE WORLD'S FINEST  
GOVERNMENT SURPLUS  
ELECTRONIC EQUIPMENT

And BETTER Than Ever

Name \_\_\_\_\_  
Address \_\_\_\_\_  
City \_\_\_\_\_ State \_\_\_\_\_ Zip \_\_\_\_\_

Mail Coupon for Your FREE Copy, Dept. RE

**FAIR RADIO SALES**  
1016 E. EUREKA • Box 1105 • LIMA, OHIO • 45802

## DIGITAL CLOCK

10:48:37

Wired Only - \$89.25 Ppd

Beautiful walnut/metal case only 3 1/2" x 3 1/2" x 7"; BCD output LARGE Perty display - .55" high body. 90 day warranty. With 26 page manual only - \$2.50

Free info., these & other digital kits, request cat.# B-6 Master Charge, BankAmericard & COD orders welcome. HUNNICUTT DIGITAL ELECTRONICS, Box 9793, Ft. Worth, Tex. 76107

# Technical Excellence in Electronics.

On our small, friendly campus the emphasis is on Living as well as Learning. Extra-curricular social activities, student clubs, a student operated radio station, student government, new dormitory and a full sports program help provide a world of your own in which to prepare for tomorrow. Associate Degree in Engineering Electronics. B.S. obtainable. G.I. approved.

**VALPARAISO TECHNICAL INSTITUTE**  
Dept. C, Yellowstone Trail, Valparaiso, Indiana 46383

# LIVE IN THE WORLD OF TOMORROW... TODAY! NEW PRODUCTS, NEW MATERIALS, NEW IDEAS!

## UNUSUAL ECOLOGICAL SCIENCE BOYS

### & PHYSICAL

# UNIQUE HARD-TO-FIND BARGAINS FOR FUN, STUDY OR PROFIT

#### TAPE-SLIDE SYNCHRONIZER



Coordinate tape recordings with slide series. Hook up stereo recorder to remote control projector and TSS—then record what you wish for each slide. Playback and TSS AUTOMATICALLY changes slides in synch. w/tape. Your presentation "gives itself". Perfect for sales meetings, lectures, & vacations, parties... anywhere.

Stock No. 41,222EH ..... \$21.95 Ppd.  
 6-FT CONNECTOR CORDS ..... \$4.75 Ppd. each  
 Kodak Proj. (#60,804EH) Airrequisit (#60,805EH)

#### NEW ELECTRONIC CALCULATOR—\$99.50



Terrific American-made value w/big machine capabilities. Add, subtract, multiply, divide, do mixed calculations—silent answers in mill-seconds 8 digit entry & readout w/16-digit cap. Auto. precise to the decimal. Also features fixed decimal, constant key underflow, zero suppression, minus signal for true credit balance, error correction, keyboard roll over memory. Solid state; modular contr., only 3-lb. Year guarantee (normal use).

Stock No. 78,000EH ..... (6½ x 9 x 2" H) ..... 99.50 Ppd.

#### ULTRA LOW PRESSURE SENSOR



Big surplus bargain—tiny electrical pressure switch activated by only 0.02 psi air or ¼" or less water pressure. Single pole, normally open. 10 ma DC contact rating. 30V AC/DC (usual loads require sensitive relay or solid state control). Use as sensor, switch, control, counter.

edge guide, instrument alarm. Long life (1,000,000 operations), impervious to shock, vibration. 1" sq. polycarbonate case, 3/16" diam. barbed pressure ports. Wt—10 grams. ORIGINAL COST \$11.50.  
 Stock No. 41,623EH ..... \$3.95 Ppd.

#### FEATHERWEIGHT TREASURE FINDER



Best, easiest to use solid state metal detector at its price. U.S. made! Only 3 lbs! 6" head detects penny at depth of 5', silver dollar at 8', bag of coins at 18". Works thru dirt, sand, wood, water (30" deep), rock with no power loss. Detects "find" with "sound off" loudspeaker. Ready to go. One

tuner control; all trans.; adjust stem; perfect balance. Includes 9v batt. FREE TREASURE GUIDE To 101 Treasure Sites.  
 Stock No. 80,175EH ..... \$39.95 Ppd.

#### NEW! ELECTRONIC DIGITAL COMPUTER KIT!



Solve problems, play games, predict weather with this actual working model of giant electronic brains. Amazing new fun way to learn all about computer programming logic, decimal, binary systems. Laws of Sets—even do your own programming after completing simplified 116 page

instructive booklet. Includes step-by-step assembly diag. Circuits easily changed. Readout from illuminated control panel. Req. 2 "D" batt. (not incl.). Best model—for home, school, industry.  
 No. 71,434EH ..... (11" x 12½" x 4") ..... \$31.50 Ppd.

### MAIL COUPON FOR GIANT FREE CATALOG!

**164 PAGES • MORE THAN 4,000 UNUSUAL BARGAINS**

Completely new 1973 edition. New items, categories, illustrations. Dozens of electrical and electromagnet parts, accessories. Enormous selection of Astronomical Telescopes. Unique lighting and ecological items. Microscopes, Binoculars, Magnifiers, Magnets, Lenses, Prisms. Many surplus items.

**EDMUND SCIENTIFIC CO.**  
 Barrington, N.J. 08007  
 Please rush Free Giant Catalog "EH"

Name \_\_\_\_\_  
 Address \_\_\_\_\_  
 City \_\_\_\_\_ State \_\_\_\_\_ Zip \_\_\_\_\_

#### 130 EXPERIMENTS IN OPTICS... PHOTOGRAPHY



Optik(R) Experiments Kit is a complete optical & photography lab for 130 exciting experiments. Lets you recreate the periscope, telescope, microscope, kaleidoscope! Build a 35mm reflex camera with interchangeable lens system! Make, develop photographic film! Enjoy the fun and fascination of having your own optics lab. Fully illustr 112-pg manual, 8½x11", clearly explains usage of this stimulating kit's 114 precision engineered components.  
 Stock No. 71,646EH ..... \$21.00 Ppd.

#### STOP THIEVES! ENGRAVE NOW!

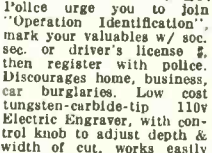

Urges you to join "Operation Identification", mark your valuables w/ sec. sec. or driver's license #, then register with police. Discourages home, business, car burglaries. Low cost tungsten-carbide-tip 110V Electric Engraver, with control knob to adjust depth & width of cut, works easily on metal, glass, plastic, wood, steel, most hard surfaces. Incl. 2 "Operation Identification" window stickers, 10 "Stop Thief" labels, instructions.  
 Stock No. 60,971EH ..... \$9.95 Ppd.

#### TERRIFIC BUY IN HE-NE LASERS



Low price on 0.5mW Laser (random mode); 0.9mm beam dia. (at 10M,16mm) belies its quality. New cold aluminum cathode tube for more life stability (hi beam: 9000-hr tube life under normal cond.) Ready to plug in, turn on. Starts instantly. Safe, easy for holography, interferometry, alignment. Metal case, 2.8 x 3.8 x 10", 110V AC. 633nm wavelength, small beam divergence.  
 Stock No. 79,024EH ..... 88.50 Ppd.  
 0.7mW (SINGLE TEMMODE), 0.8mm BEAM DIA.  
 Stock No. 79,024EH ..... \$99.50 Ppd.

#### SLIDE-SHOW "BRAIN & VOICE"

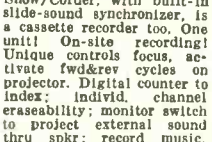

Show/Order, with built-in slide-sound synchronizer. Is a cassette recorder, too. One unit! On-site recording! Unique controls focus, activate fwd&rev cycles on projector. Digital counter to index; individ. channel erasability; monitor switch to project external sound thru spkr; record music, narration at same time. 10-level vol. control. AC/DC. Incl. cable for Kodak Carousel(R), patch cord (radio, hi-fi), earphone, remote mike, blank cassette. 4 "C" batt., instrs.  
 No. 71,619EH ..... (9x8"x2") .. (5¼ lb.) .. \$171.50 Ppd.

#### FLEXIBLE IMAGE TRANSMITTER



Hi-resolution image-transmitter lets you see remote, inaccessible lighted areas; thru pipes, tubes, any ¼" opening no matter how intricate. Provides clear, wide sighting. 7X magnifying eyepiece focuses from less than ¼" away. Ideal for monitoring hazardous processes, surveillance instr., 4,000 coherent glass fibers gooseneck sheathing.  
 demons, fiber optics. Over (0.02"), ¾" dia. semi-rigid  
 Stock No. 60,857EH ..... \$40.00 Ppd.

#### 3" ASTRONOMICAL TELESCOPE

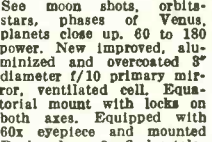

See moon shots, orbitars, phases of Venus, planets close up. 80 to 180 power. New improved, aluminum and overcoated 3" diameter f/10 primary mirror, ventilated cell. Equatorial mount with locks on both axes. Equipped with 60x eyepiece and mounted Barlow lens. 3x finder telescope, hardwood tripod.  
 Included FREE: "STAR CHART"—"HOW TO USE YOUR TELESCOPE".  
 Stock No. 85,050EH ..... \$32.95 Ppd.  
 No. 80,162EH ..... DELUXE 3" ..... \$61.50 Ppd.  
 Stock No. 85,105EH ..... 4" ..... \$99.50 FOB  
 Stock No. 85,086EH ..... 6" ..... \$239.50 FOB

#### MEASURE TEMPERATURE REMOTELY



Electronic thermometer gives instant temperatures from inches to 1000-ft. off. Push button, read one of 3 separate temps. (Can connect to 3 plug-in probes). Reads from -32 to +122°F & -30 to +50°C. Accuracy ±1%. Incl. 2 solid-state waterproof probes (one w/18" cable, one 15-ft.). 100's of uses in home, lab, industry. Req. "D" batt. (not incl.). Walnut fin. cab instrs.  
 Stock No. 71,741EH ..... (3½"x4½"x6¾") ..... \$40.90 Ppd.  
 EXTRA 15-FT. TEMPERATURE PROBE ..... \$4.95 Ppd.  
 Stock No. 41,839EH ..... \$2.35 Ppd.

#### KNOW YOUR ALPHA FROM THETA!

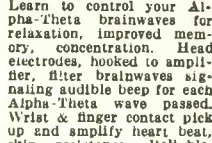

Learn to control your Alpha-Theta brainwaves for relaxation, improved memory, concentration. Head electrodes, hooked to amplifier, filter brainwaves signifying audible beep for each Alpha-Theta wave passed. Wrist & finger contact pick up and amplify heart beat, skin resistance. Reliable, easy-to-use trainer unit offers features comparable to many higher-priced models. Completely safe. Most people can learn Alpha rhythm control in 10-12 hrs with full instructions included.  
 Stock No. 71,606EH ..... \$120.00 Ppd.

#### STROBE SCREWS IN ANYWHERE

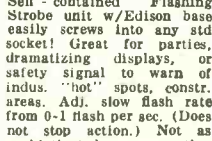

Self-contained Flashing Strobe unit w/Edison base easily screws into any std socket! Great for parties, dramatizing displays, or safety signal to warn of indus. "hot" spots, constr. areas. Adj. slow flash rate from 0-1 flash per sec. (Does not stop action.) Not as sophisticated as our other strobes, but very handy & economical. Avg. life: 5 million flashes, 120V, 60 Hz, Approx 5x3" dia.  
 Stock No. 41,913EH ..... \$27.50 Ppd.  
 REPLACEMENT BULB, No. 41,918EH ..... \$4.75 Ppd.

#### GET POLICE, AIRCRAFT CALLS

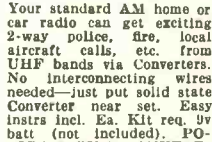

Your standard AM home or car radio can get exciting 2-way police, fire, local aircraft calls, etc. from UHF bands via Converters. No interconnecting wires needed—just put solid state Converter near set. Easy instrs incl. Ea. Kit req. 9v batt (not included). POLICE & FIRE CONVERTER KIT — LO BAND. Operates in the 30-50 MHz band.  
 Stock No. 41,826EH ..... \$8.25 Ppd.  
 AIRCRAFT CONVERTER KIT. Operates in the 108-138 MHz band.  
 Stock No. 41,827EH ..... \$8.25 Ppd.

#### UNDERWATER MICROPHONE BUY

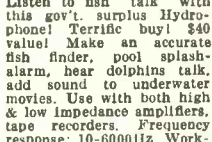

Listen to fish "talk" with this gov't surplus Hydrophone! Terrific buy! \$40 value! Make an accurate fish finder, pool splash-alarm, hear dolphins talk, add sound to underwater movies. Use with both high & low impedance amplifiers, tape recorders. Frequency response: 10-60000 Hz. Working depth to 300 ft. Minimum sensitivity 1000 Hz. at depths of 60 or 300 ft. Operating temperature range: 0 to 35°C. Fungus and shock resistant. Includes leads (approx. 100 ft) and instrs. Cable not incl. Wt. 2 oz.  
 Stock No. 41,759EH ..... \$5.00 Ppd.

#### 1st LOW-COST VACUUM PUMP!

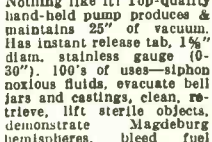

Nothing like it! Top-quality hand-held pump produces & maintains 25" of vacuum. Has instant release tab, 1½" diam. stainless gauge (0-30"). 100's of uses—siphon noxious fluids, evacuate bell jars and castings, clean, retrieve, lift sterile objects, demonstrate Magdeburg hemispheres, bleed fuel lines, check leaks, etc. Lifts 40 lbs. with included "T" Lifter (2½" diam. cup)—much more w/larger cup.  
 Stock No. 71,301EH ..... \$12.00 Ppd.  
 No. 71,300EH (without gauge/lifter) ..... 5.50 Ppd.

#### ASTRONOMICAL TELESCOPE KITS

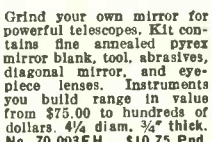

Grind your own mirror for powerful telescopes. Kit contains fine annealed pyrex mirror blank, tool, abrasives, diagonal mirror, and eyepiece lenses. Instruments you build range in value from \$75.00 to hundreds of dollars. 4¼" diam, ¾" thick.  
 No. 70,003EH ..... \$10.75 Ppd.  
 Stock No. 70,004EH ..... 6" diam, 1" thick \$16.95 Ppd.  
 Stock No. 70,005EH ..... 8" diam, 1½" thick \$24.50 Ppd.  
 Stock No. 70,006EH 10" diam, 1¾" thick 30 lbs \$44.50 FOB  
 Stock No. 70,007EH 12½" diam 2½" thick 46 lbs \$72.50 FOB

#### "FISH" WITH A MAGNET

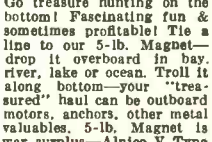

Go treasure hunting on the bottom! Fascinating fun & sometimes profitable! Tie a line to our 5-lb. Magnet—drop it overboard in bay, river, lake or ocean. Trawl it along bottom—your "treasured" haul can be outboard motors, anchors, other metal valuables. 5-lb. Magnet is war surplus—Alnico V Type —Gov't. cost \$50. Lifts over 150 lbs. on land—much greater weight under water.  
 Stock No. 70,571EH ..... \$14.00 Ppd.  
 Stock No. 70,570EH 3-½ LBS ..... \$8.75 Ppd.  
 Stock No. 85,152EH 15¼ LBS ..... \$39.60 F.O.B.

# EDMUND SCIENTIFIC CO.

ORDER BY STOCK NUMBER · SEND CHECK OR MONEY ORDER · MONEY-BACK GUARANTEE

## 300 EDSCORP BLDG.

### BARRINGTON, NEW JERSEY 08007

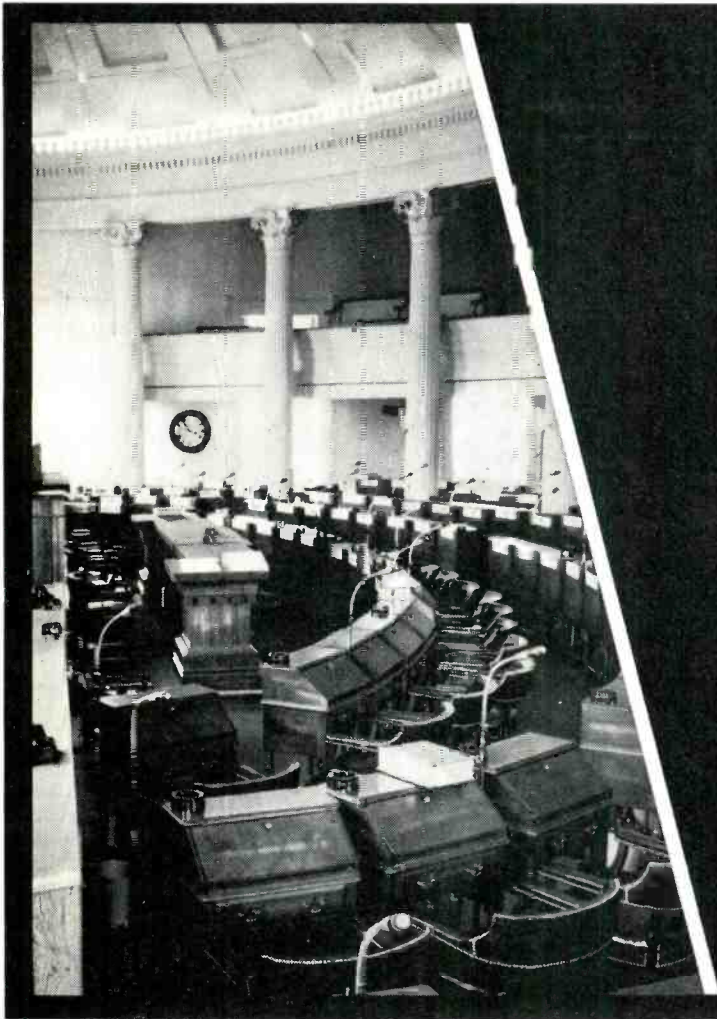

## Con-Con to Congress



Nowadays, history isn't written, it's spoken . . . and verbal clarity is essential wherever people meet to discuss the issues of the day. From coast to coast, from town halls to the halls of Congress, you'll find Shure microphones in the really critical, prestigious sound reinforcement installations. Case in point: when the Illinois Constitutional Convention ("Con-Con"—see photo above) met to create the first new state constitution since 1870, a total of 65 Shure Unidyne III microphones were at hand to assure a clear, intelligible voice for each delegate. The Unidyne III was right for Con-Con, and there's a Shure problem-solving microphone right for every installation.

Write:

Shure Brothers Inc.  
222 Hartrey Ave., Evanston, Ill. 60204



*Circle 93 on reader service card*

THE  
CONWAY  
"MASTERANGER™"  
MODEL 639



This remarkable new  
Multitest set  
is unique  
in its versatility,  
in its sensitivity,  
and in its price.

100M $\Omega$  input resistance; accurate to 1.5%. 72 Ranges. Floating input for absolute user safety; fully overload protected. Completely portable; battery or AC operation. Attributes such as these make the Conway "MASTERANGER™" the new standard instrument for all electronics. Its price \$150.\*

\*(Cdn. Dollars, export price—local taxes and duties extra.)

The Conway Masteranger solid state Model 639 is the world's most comprehensively ranged F.E.T. Multimeter. It is the result of five years' intensive research and study to determine the most required measurement parameters and ranges for the rapid testing of AC/DC Voltages, Current, Decibel, Resistance and Voltage Levels.

Its design concept employs 100% silicon solid state technology, making it applicable for the measurement of any anticipated electronic development over the next 10 years. It can also carry out its functions on all contemporary equipment, and that of earlier technologies.

Like many genuine technical advances, its principle is simple enough to make the Conway Masteranger relatively inexpensive. At \$150, it renders many other instruments (some much more expensive) either obsolete or unnecessary.

The Masteranger 639 is amazingly accurate—plus or minus 1.5% through most of its 72 ranges. Its input resistance is high—100M $\Omega$  on most voltage ranges. This, coupled with its outstanding sensitivity of 1.5mV AC or DC (full scale) and its current measuring capability from 0.15 $\mu$ A (150nA) (full scale) up to 150A (full scale); AC/DC (with shunt box) puts the Masteranger Multitest set in a class of its own.

The instrument is supplied in a smart bridle leather carrying case with detachable shoulder and neck strap. At 2.5Kg (5.5 lbs) it is easily carried.

A wide range of quality matching accessories are available. RF probe extending frequency response to 1000 MHz, current range extension to 150 Amps AC and DC in 4 ranges, HV probe, Powerline cassette, Coaxial "T", etc.

Complete information, and specification sheets, on this unique professional Multitest set is available on request. Simply fill out the coupon below and mail to:



**CONWAY ELECTRONIC ENTERPRISES LIMITED**

88-90 ARROW ROAD, WESTON, ONTARIO, CANADA

Telephone (416) 742-6631

Telex 06-965733

Gentlemen: Please send me complete information on the Masteranger 639 solid state Multitest set.

Name: \_\_\_\_\_ Title: \_\_\_\_\_

Company: \_\_\_\_\_

Nature of Business: \_\_\_\_\_

Co. or Res. Address: \_\_\_\_\_

Country: \_\_\_\_\_ State, Prov. or Zone: \_\_\_\_\_ Postal Zone: \_\_\_\_\_

Circle 94 on reader service card